

FOCKE-WULF FW 200c CONDOR

THE SCALE OF
THIS MODEL IS
1/72 ACTUAL SIZE

Revell
Authentic Kits

Printed in Great Britain for Revell (Great Britain) Limited,
Cranborne Road, Potters Bar, Herts., England.
H-204

One of the major shortcomings of the German Luftwaffe was the almost total lack of long-range heavy bombers. Not long after Germany had begun their assault on the British the Germans found themselves in need of a heavy bomber suitable for attacking the British convoys far at sea. Since the need was immediate and the time required to develop a new aircraft would be extensive, the only course open to them was the conversion of a new civil airliner, the FW 200 Condor, into the bomber role. Strangely, this became one of the most successful conversions of the war, even though the Condor was not ideally suited for this role. Its unusual success lay in the inadequate protection and extreme vulnerability of the Allied convoys to aerial attack.

The Focke Wulf FW 200 was originally designed as a long-range civil airliner for the German airline, Deutsche Lufthansa. In this configuration the FW 200 carried 26 passengers and a crew of four. The performance of the Condor was noteworthy and following several spectacular demonstration flights the four-engine airliner was ordered by Denmark and Japan. Ironically, the Japanese were planning to convert the FW 200 into a long-range reconnaissance plane — the role the Condor ultimately filled for Germany.

The first Condor bombers began operations in the fall of 1940. In a very short while the ponderous raider with its distinctive offset bomb gondola became a dreaded sight to Allied seamen. Working with the notorious U-boats, Condors would guide the German submarines directly to the Allied convoys. With bombers attacking from above, and U-boats below, the toll of Allied ships rose alarmingly. The FW 200C-3/U1 could deliver over 4,600 lbs. of bombs in low level assaults. This version of the Condor was armed with an MG 151 20mm cannon in the forward portion of the gondola and a 15mm cannon in the upper forward turret. This heavy forward armament proved quite successful for low-level attacks.

Roaming the North Atlantic almost unmolested, Condors sank hundreds of thousands of tons

of Allied shipping and their two-year reign of destruction gained them a place in history as the "Scourge of the Atlantic." As an attempt to improve the defense of the convoys, British Hawker Hurricane fighters were mounted on catapults on merchant ships to be launched when the huge bombers appeared. Called "Hurricats," their first victory was recorded on August 3, 1941 when a Condor fell before a Hurricat's guns. Following the victory, the fighter was ditched alongside a merchant ship and the pilot recovered.

Early in 1943, the U.S. Army began operating long-ranging B-24D's on anti-submarine and convoy protection duties. By August of that year, the job was taken over by Navy PB4Y-1's and the Condors found themselves no match for the American bombers. Increased anti-aircraft protection on the ships were making low-level assaults extremely hazardous and the FW 200's were forced to make their attacks from greater altitudes, thus reducing their effectiveness.

Gradually the Condors were withdrawn from their reconnaissance-bomber role and replaced by the less successful He 177. The retired FW 200's were returned to the duty for which they were primarily designed — personnel and cargo transport.

Revell's replica of the Condor represents the FW 200C3/U1 version of this German bomber. This version was powered by four BMW-Bramo 323R-2 engines. These nine cylinder air-cooled engines provided 1,200 h.p. with water-methanol injection. Normal bomb load consisted of twelve 110 lb. bombs in the fuselage bay, two 550 lb. bombs in underwing racks and one 1,100 lb. bomb under each outer engine nacelle. Gross weight was 46,300 lbs. The wing spanned 107 ft. 9½ in. and overall length was 76 ft. 11½ in.

Service ceiling was 19,000 ft., maximum speed was 224 m.p.h.; this was attained at 15,700 ft. The normal range was 2,210 miles and endurance was approximately 14 hours.

Your Revell Focke-Wulf FW-200C Condor is another authentic representation of a page from aviation history.

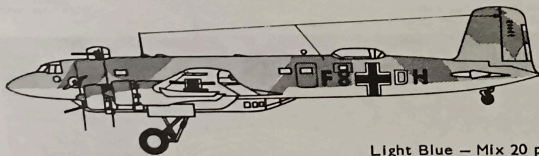

Light Blue — Mix 20 parts Matt White
with 1 part Matt Blue
and 1 part Olive Green

Dark Green — Mix 5 parts Olive Green
with 1 part Matt Black

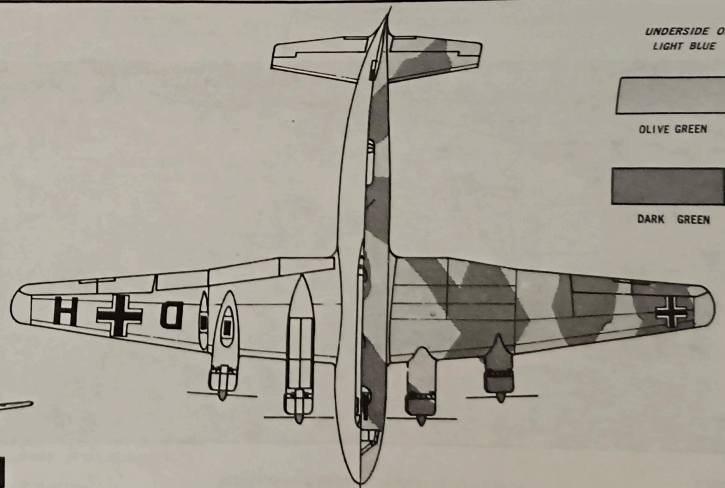

UNDERSIDE ONLY
LIGHT BLUE

OLIVE GREEN

DARK GREEN

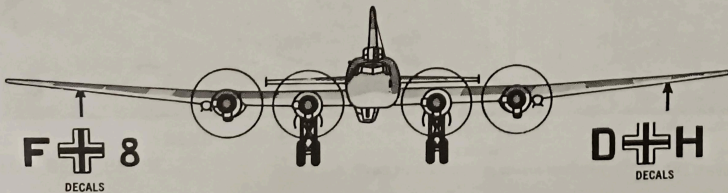

F + 8
DECALS

D + H
DECALS

FOR BEST RESULTS,

READ THIS FIRST.

This kit is moulded of styrene plastic. REVELL CEMENT & PAINTS are made especially for use with this material. Always fit parts together to be assured of proper assembly before cementing.

Before assembling, paint parts as indicated **SILVER** and allow to dry. Avoid spilling cement on paint, on clothing, or furniture.

H-204

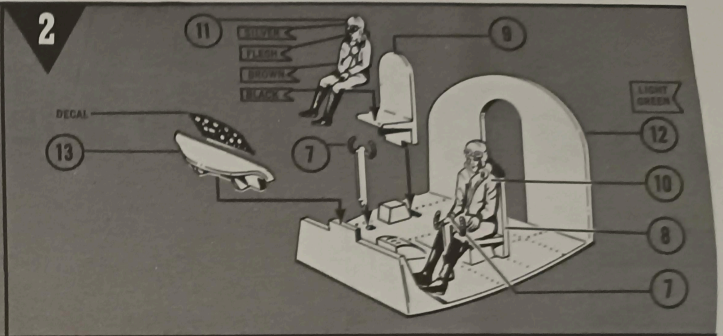
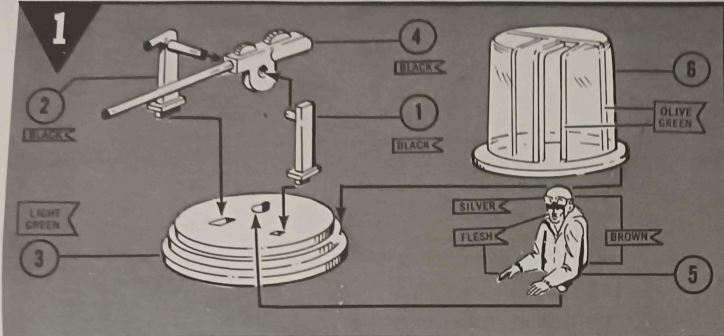

PARTS LIST

ASSEMBLY INSTRUCTIONS

Light Green – Mix 1 part Olive Green with 2 parts Matt Yellow

- Cement Parts 1 and 2 into Part 3 with Part 4 located, (NOT CEMENTED) between them as shown.
- Cement Parts 5 and 6 into place. Set aside to dry.

PARTS LIST

ASSEMBLY INSTRUCTIONS

- Cement (2) Parts 7 and Parts 8, 9, 10 and 11 to Part 12 as shown.
- Apply decal to Part 13 and then cement Part 13 to Part 12. Set aside to dry.

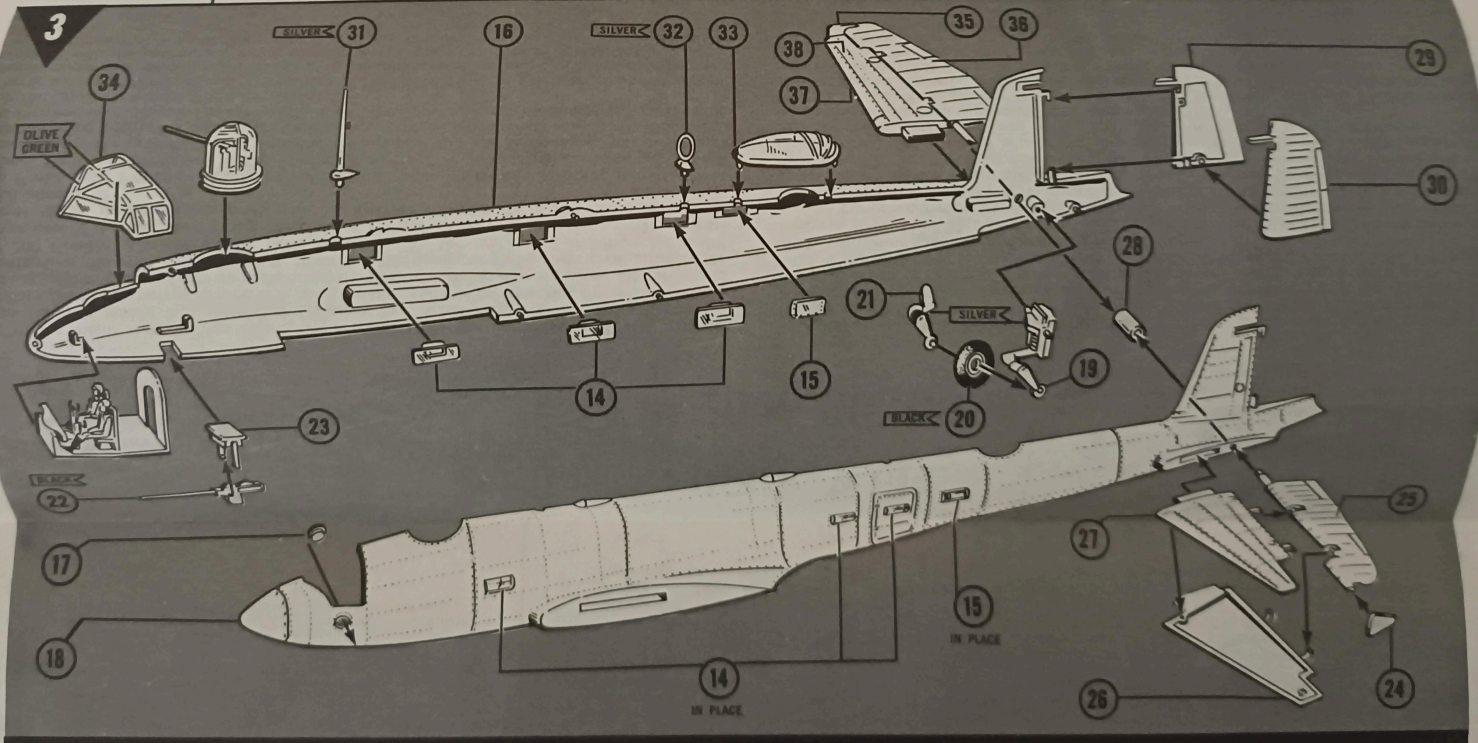

PARTS LIST

ASSEMBLY INSTRUCTIONS

- Cement (3) Parts 14 and (1) Part 15 into Part 16 and the
- Press (DO NOT CEMENT) Part 28 to the elevator pin on the inside of the fuselage as shown.

PARTS LIST

- | | |
|-----------------------|---------------------------------------|
| 14. WINDOW (5) | 26. HORIZONTAL STABILIZER, LOWER HALF |
| 15. WINDOW (2) | 27. HORIZONTAL STABILIZER, UPPER HALF |
| 16. FUSELAGE (STBD.) | 28. TORQUE TUBE |
| 17. WINDOW (CIRCULAR) | 29. RUDDER (STBD. HALF) |
| 18. FUSELAGE (PORT) | 30. RUDDER (PORT HALF) |
| 19. TAILGEAR | 31. RADIO MAST |
| 20. TAILWHEEL | 32. RADIO LOOP |
| 21. TAILGEAR FORK | 33. DORSAL CANOPY |
| 22. 20 MM CANNON | 34. COCKPIT CANOPY |
| 23. GUN MOUNT | 35. ELEVATOR BALANCE |
| 24. ELEVATOR BALANCE | 36. ELEVATOR (STBD.) |
| 25. ELEVATOR (PORT) | 37. HORIZONTAL STABILIZER, LOWER HALF |
| | 38. HORIZONTAL STABILIZER, UPPER HALF |

ASSEMBLY INSTRUCTIONS

- Cement (3) Parts 14 and (1) Part 15 into Part 16 and the remaining (3) Parts 14 and Part 15 and Part 17 into Part 18.
- On the cone boss of Part 19, position Part 20, then cement into place Part 21. Check that Part 20 rotates freely and set aside to dry.
- Snap (DO NOT CEMENT) Part 22 into Part 23 then cement this assembly into position as shown.
- Cement Part 24 to Part 25, then Parts 26 and 27 together, trapping the elevator between them. The elevator must move freely.
- Cement this assembly into place on Part 18 at the stabilizer section only. The elevator must be kept free of cement.

- Press (DO NOT CEMENT) Part 28 to the elevator pin on the inside of the fuselage as shown.
- Cement Flight Deck Assembly into place in Part 16 and locate (DO NOT CEMENT) Turret and Tailgear Assemblies in position as shown. Carefully cement Parts 16 and 18 together trapping the turret and tailgear into place.
- Cement Parts 29 and 30 together around the pins at the tail section. Be careful that cement does not touch the hinge or the rudder will not turn.
- Locate and cement into place Parts 31, through 34.
- Cement Part 35 to Part 36 and then Parts 37 and 38 together trapping the elevator between them.
- Cement this assembly to Part 16 at the stabilizer section only, locating the elevator pin into Part 28.

4

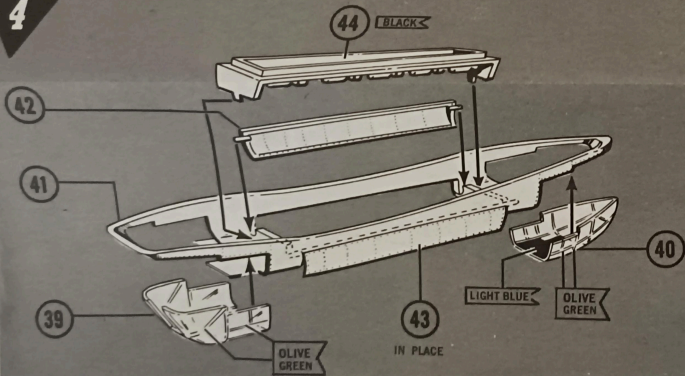

PARTS LIST

- | |
|----------------------------|
| 39. GONDOLA FORWARD CANOPY |
| 40. GONDOLA REAR CANOPY |
| 41. GONDOLA |
| 42. BOMB DOOR, STBD. |
| 43. BOMB DOOR, PORT |
| 44. BOMB-BAY |

ASSEMBLY INSTRUCTIONS

- Cement Parts 39 and 40 to Part 41 as shown.
- Locate (DO NOT CEMENT) Parts 42 and 43 inside Part 41 then cement Part 44 in place. Check that Parts 42 and 43 move freely.
- Cement this assembly in position to the underside of the fuselage.

5

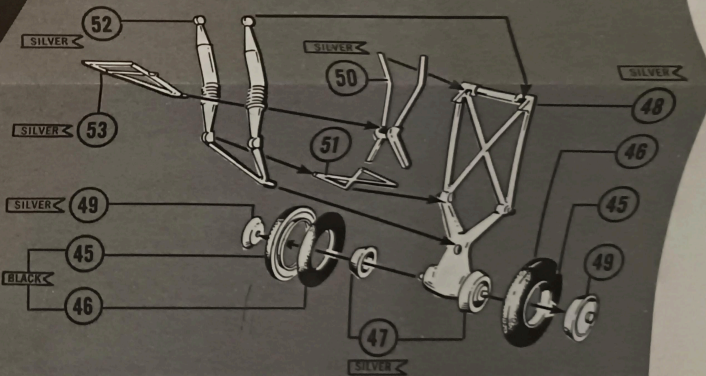

PARTS LIST

- | |
|--------------------------|
| 45. MAIN TYRE — HALF (4) |
| 46. MAIN TYRE — HALF (4) |
| 47. WHEEL BEARING (4) |
| 48. MAIN GEAR LEG (2) |
| 49. WHEEL HUB (4) |
| 50. BRACE (LARGE) (2) |
| 51. BRACE (SMALL) (2) |
| 52. SHOCK STRUT (2) |
| 53. RETRACTING LINK (2) |

ASSEMBLY INSTRUCTIONS

- If you desire your model in the flight position with landing gear retracted, omit this assembly and proceed with Assembly 6.
- Cement together (4) Parts 45 to (4) Parts 46.
 - Cement (2) Parts 47 to each Part 48.
 - Place wheels on Part 47 and retain in position by cementing in place (4) Parts 49. Keep cement away from the wheels or they will not turn.
 - To each Part 48 cement one each Part 50, 51 and 52 as shown.
 - Cement to each Part 50 (1) Part 53. Set aside to dry.

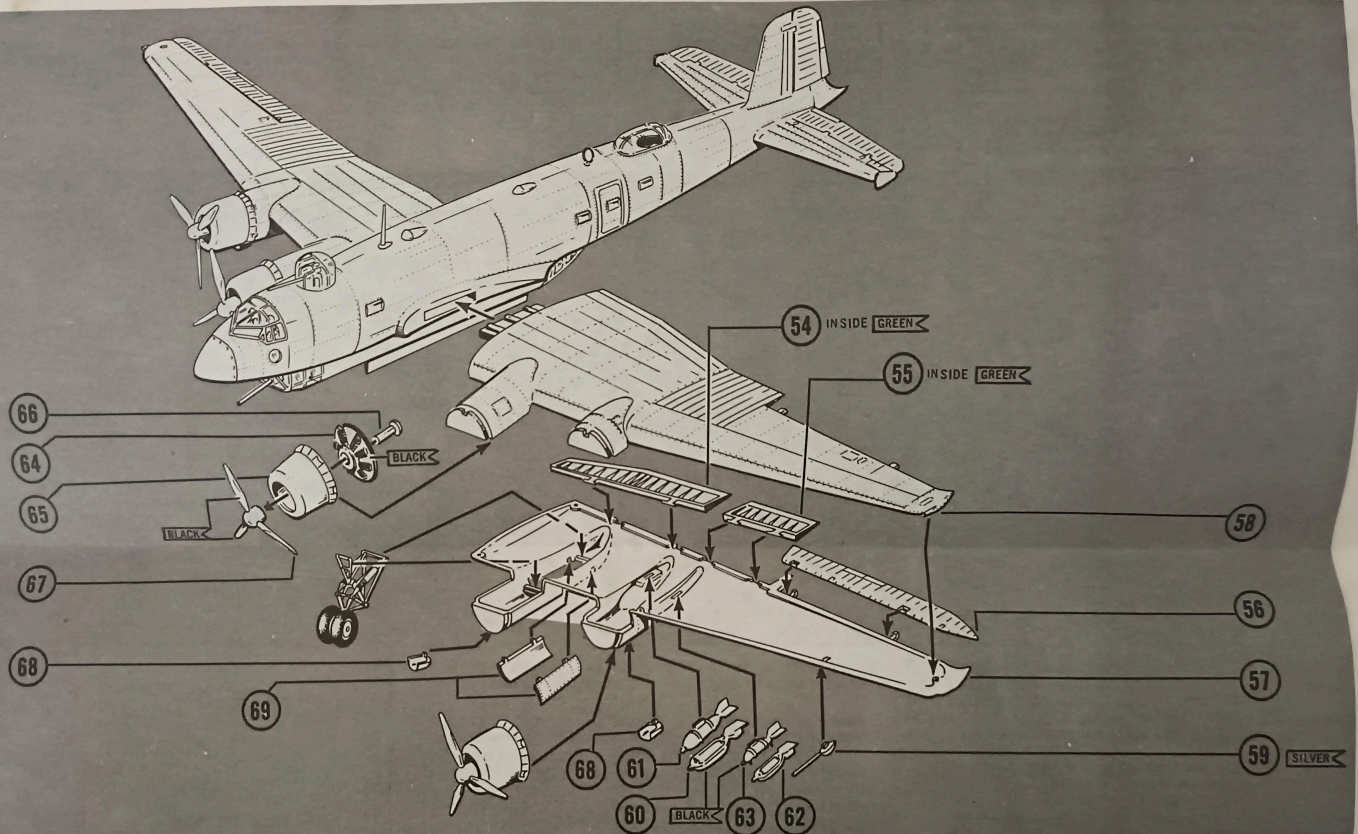

PARTS LIST

- | | |
|------------------------------------|--------------------------------|
| 54. FLAP, PORT INNER | 65. ENGINE COWLING (4) |
| 55. FLAP, PORT OUTER | 66. PROPELLER SHAFT (4) |
| 56.AILERON (PORT) | 67. PROPELLER (4) |
| 57. WING, PORT LOWER HALF | 68. ENGINE OIL COOLERS (4) |
| 58. WING, PORT UPPER HALF | 69. MAIN LANDING GEAR DOOR (4) |
| 59. PITOT TUBE | 70. FLAP, STBD. INNER |
| 60. 1,100 LB. BOMB, LOWER HALF (2) | 71. FLAP, STBD. OUTER |
| 61. 1,100 LB. BOMB, UPPER HALF (2) | 72.AILERON (STBD.) |
| 62. 550 LB. BOMB, LOWER HALF (2) | 73. WING, STBD. LOWER HALF |
| 63. 550 LB. BOMB, UPPER HALF (2) | 74. WING, STBD. UPPER HALF |

ASSEMBLY INSTRUCTIONS

1. Trapping Parts 54, 55 and 56 between them as shown, carefully cement together Parts 57 and 58. The flaps and aileron should move freely.
2. Cement into place Part 59.
3. Cement Part 60 to Part 61 and Part 62 to Part 63. Locate and cement these into place as shown.
4. Cement Part 64 inside Part 65. Press the pin of Part 66 through Part 64 and cement into Part 67. Propeller must rotate freely. Make two assemblies.
5. Cement these assemblies to the wing locations, then cement into place (2) Parts 68.
6. Locate and cement into position (1) Landing Gear Assembly followed by (2) Parts 69. If the Landing Gear Doors are desired in the closed position, omit the Landing Gear Assembly.
7. Repeat the above procedure for the Starboard Wing with the remaining Landing Gear Assembly and Parts 60 through 74.
8. Cement Wing Assemblies into position on the Fuselage as shown.
9. Refer to 3-view drawings on front page of instructions, paint and apply decals as shown.