

DD-372 USS Cassin

US Navy DD Mahan Class Post Pearl Harbor
1/700 Scale Series



Waterline
MPK710
10



For more information:
www.MidshipModel.com

Displacement: Mahan 1488t Standard 2103t full load

Dimensions

Length: 334ft wl (341 ft 10in oa)
Width: 35 ft 5in
Depth: 12 ft 4in full load
Machinery: 2 shaft GE turbines 4 blrs 49,000 shp
Speed: 36.5 knots, full load
Armament: 5 5"/38 8 21" TT (4x2)
Complement: 158

Model Master | WEM Color Coats

Black	Marine 4227	WEM C02
Dark Grey	Marine 4237	WEM US02
Deck Blue	Marine 4243	WEM US10
White	Marine 4201	WEM C03

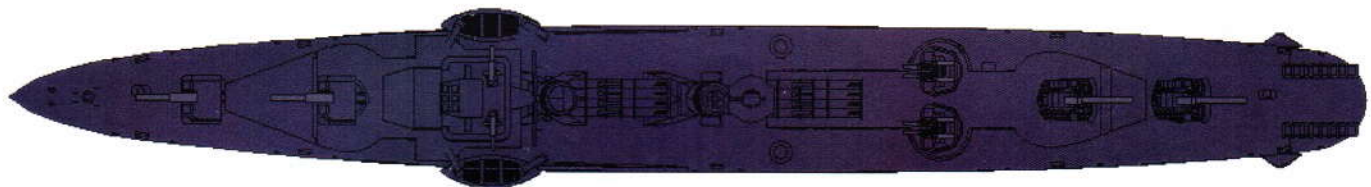
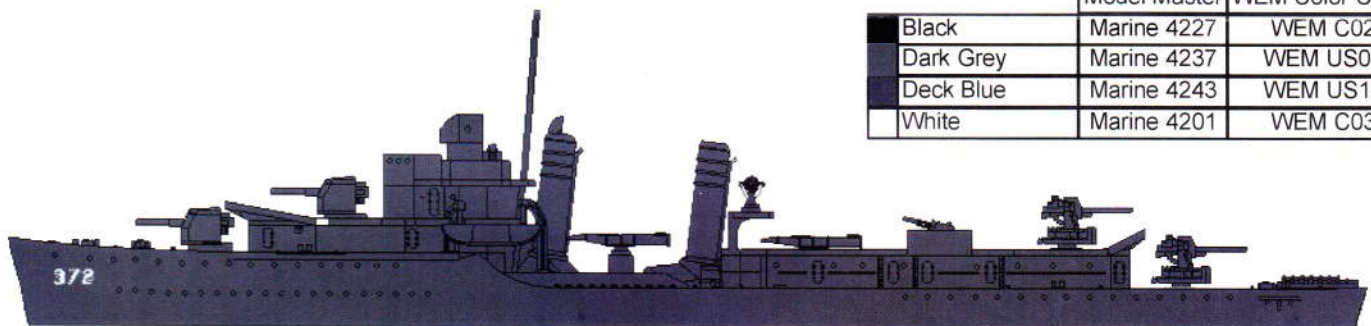

Mahan Class:	Launched	Fate
DD364 USS Mahan	Oct 15, 1935	Sunk December 7, 1944
DD365 USS Cummings	Dec 11, 1935	Broken up 1947
DD366 USS Drayton	Mar 26, 1936	Broken up 1947
DD367 USS Lamson	June 17, 1936	Expended 1946
DD368 USS Flusser	Sept 28, 1935	Broken up 1948
DD369 USS Reid	Jan 11, 1936	Sunk Nov 12, 1944
DD370 USS Case	Sept 14, 1935	Broken up 1948
DD371 USS Conyngham	Sept 14, 1935	Sunk as Target 1948
DD372 USS Cassin	Oct 28, 1935	Broken up 1948
DD373 USS Shaw	Oct 28, 1935	Broken up 1946
DD374 USS Tucker	Feb 26, 1936	Sunk April 8, 1942
DD375 USS Downes	April 22, 1936	Broken up 1948
DD376 USS Cushing	Dec 31, 1935	Sunk Nov 13, 1942
DD377 USS Perkins	Dec 31, 1935	Sunk Nov 29, 1943
DD378 USS Smith	Feb 2, 1936	Broken up 1947
DD379 USS Preston	April 22, 1936	Sunk April 22, 1942
DD380 USS Dunlap	April 18, 1936	Broken up 1948
DD381 USS Fanning	Sept 18, 1936	Broken up 1948

Sprue A - Weapons

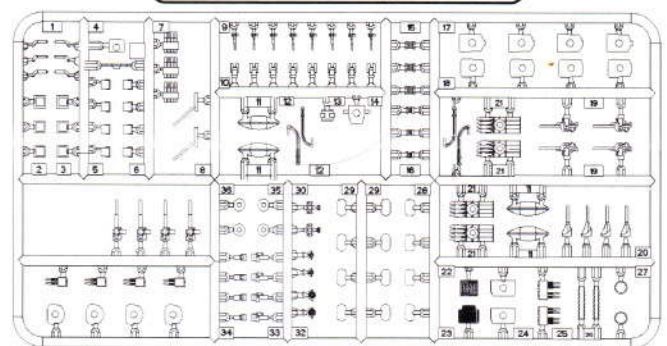

Sprue B - Ship / Structures

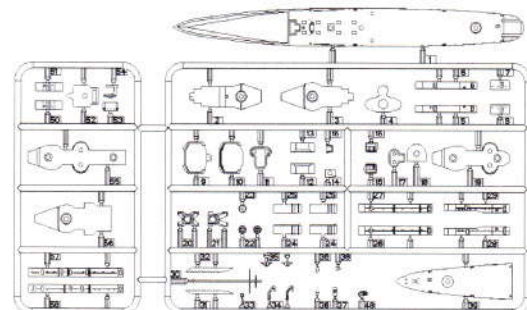

- Please read and become familiar with the instructions carefully before beginning the model.
- Glue and Paint are not included with the kit.
- Use cement sparingly and in a well ventilated area.
- Contains small detachable parts. Not suitable for children under Age 10.
- Be careful with pointed parts and tools used during the building of the kit.
- This kit contains extra pieces that may or may not be used during the assembly of the model. The instructions are intended to be a guide for assembly, and should not be taken as the definitive representation of this ship as they varied in their appearance over their life. The included extra pieces can be used to model the sister ships listed above; you are only limited by the possibilities you imagine.
- The final model may differ from the image on the front of the box.

Sub Assemblies

Open 5"/38
Mount

AS1

2X

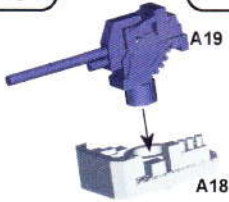

Shielded 5"/38
Mount

AS2

2X

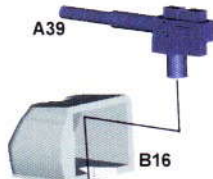

Forward
Stack

AS3



Aft
Stack

AS4

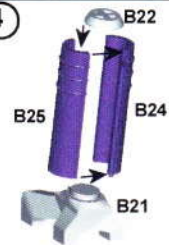

5" Gun Director

AS5

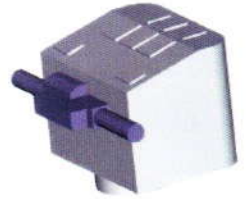
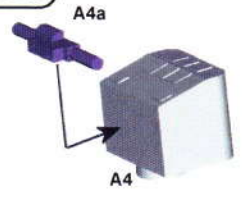

Bridge

AS6



Foward
Superstructure

AS7

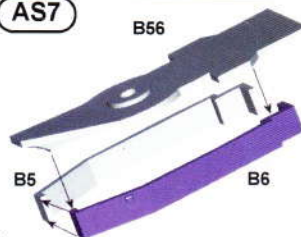

Aft
Superstructure

AS8



Single
20mm

AS9



Dual
40mm

AS10

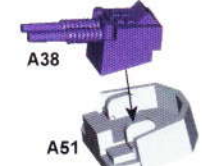

Structures

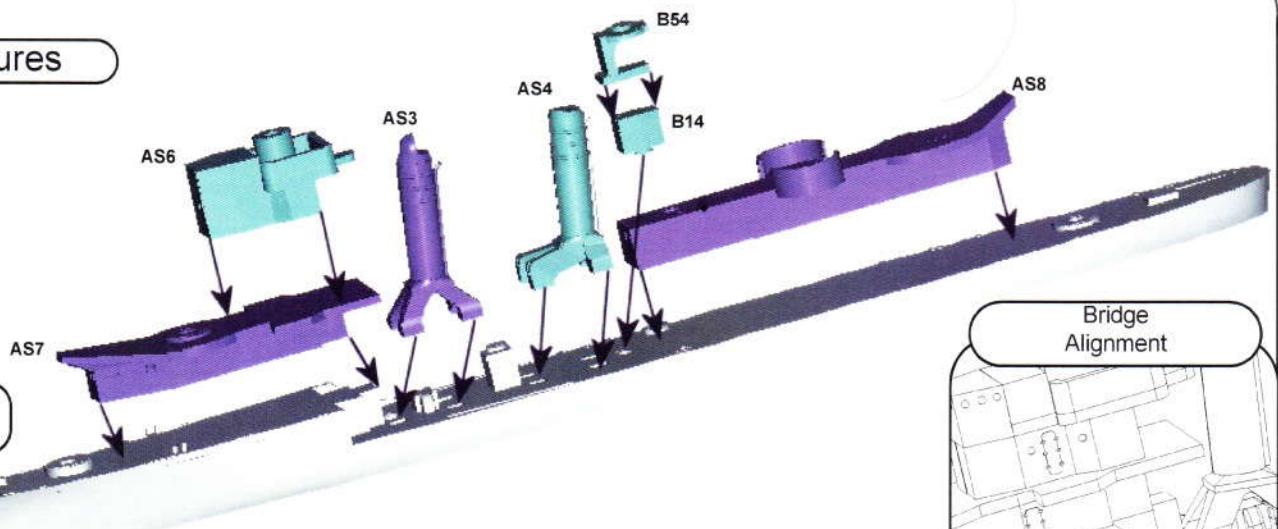

Bridge
Alignment

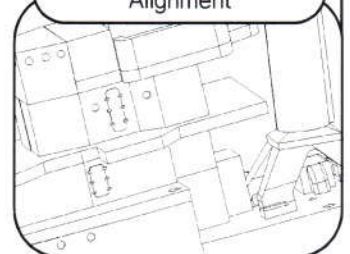

Forward Armament / Fittings

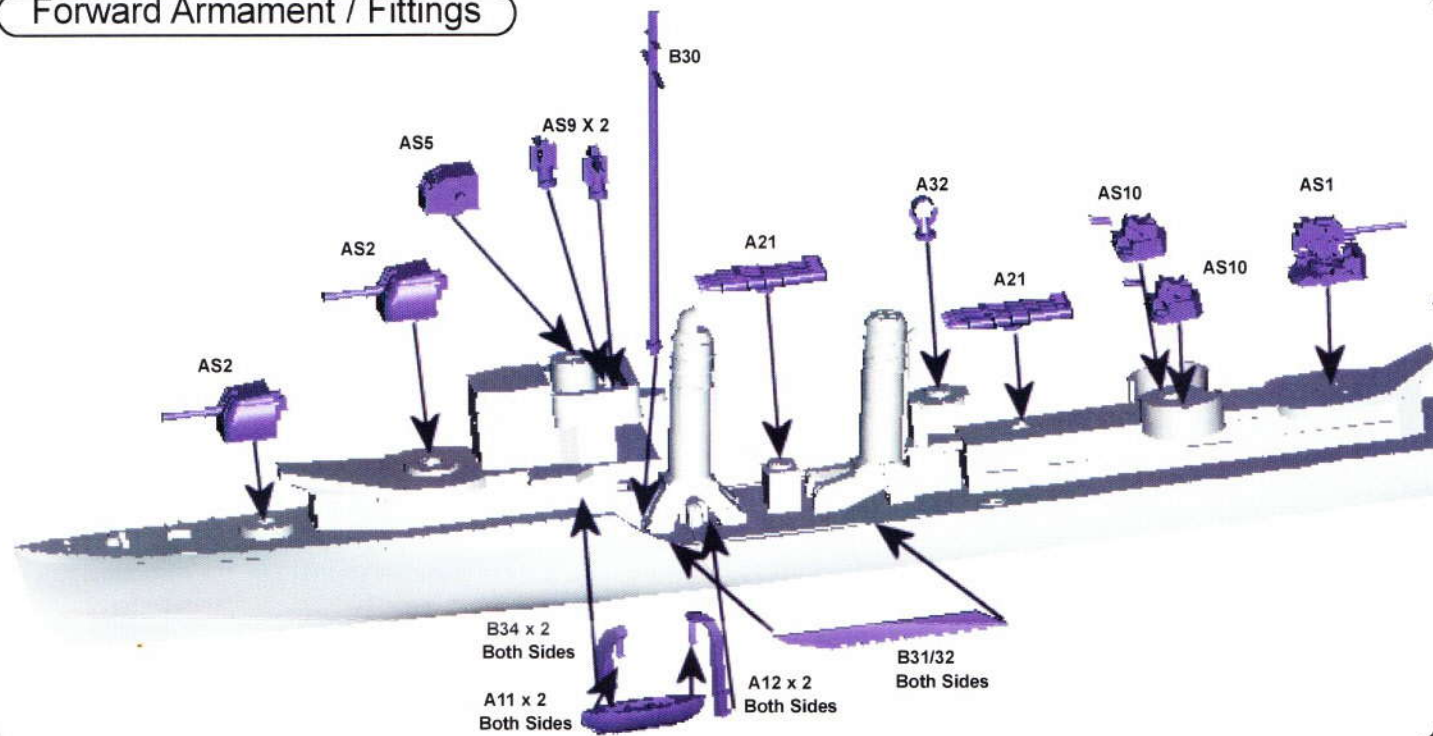

Aft Armament / Fittings

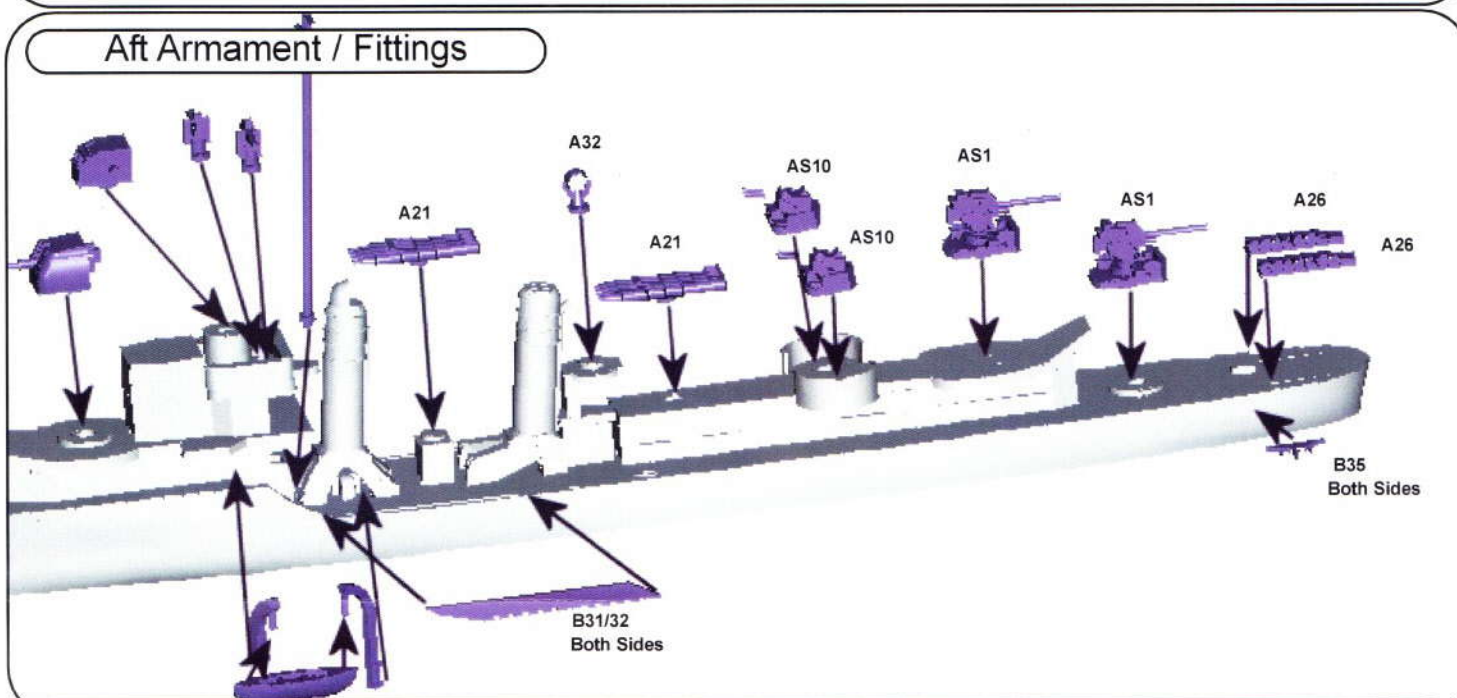

Finished Ship

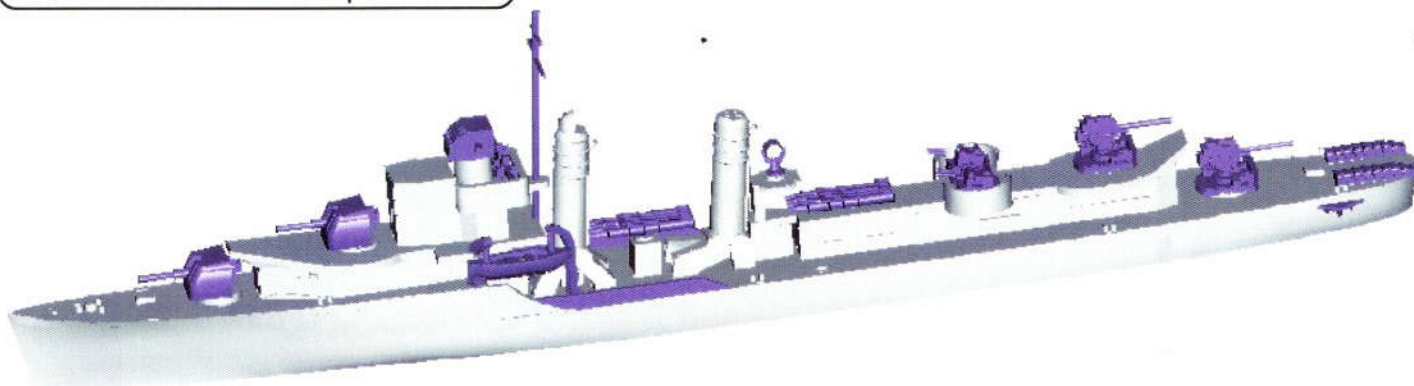



MPK 01
1/700 USS Gridley DD380
USN DD PreWWII Outfit
MSRP **\$19.99**



MPK 02
1/700 USS Benahm DD397
USN DD WWII Outfit
MSRP **\$19.99**



MPK 03
1/700 USS Henley DD391
USN DD early WWII Outfit
MSRP **\$19.99**



MPK 04
1/700 USS Stack DD406
USN DD WWII Outfit
MSRP **\$19.99**



MPK 705
1/700 USS Cleveland CL-55
USN WWII Light Cruiser
MSRP **\$35.99**



MPK 706
1/700 USS Miami CL-89
USN WWII Light Cruiser
MSRP **\$35.99**

To order missing or replacement parts or find out about upcoming kits, please see our website:
www.MidshipModels.com

Printed in USA
(C) 2006, MidshipModels



www.midshipmodels.com

Ship histories, additional instructions, future releases





© 2003 Trident Hobbies Inc.

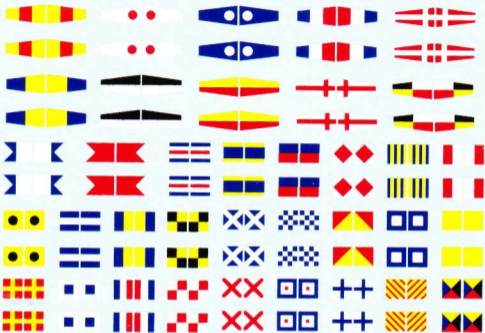

1:700th Scale USN Warship Decals

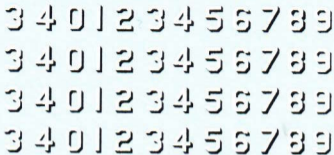

Printed by Microscale

