

# SU-34 FIGHTER / SU-34戰鬥機

ASSEMBLY METHOD: Follow assembly flow chart. 請按以下示意圖拼裝。

## 3D METAL MODEL 3D金屬模型

360°  
View

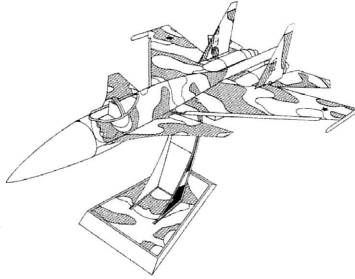

### CAUTION / 注意:

- Keep out of reach of children. 請放置于幼童接觸不到的地方。
- Warning, small parts. 請留意細小部件。
- Pay attention to sharp edges when removing pieces from the metal sheet. 取下零件時，請注意邊緣的銳點，避免劃傷。
- Carefully discard the metal sheet after parts have been removed. 零件取下後，小心處理剩餘金屬片。

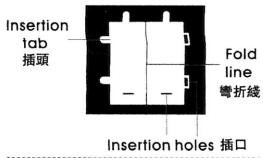

### To create the best connections

建立穩固的連接的方法:

● Insert tab and bend 90 degrees for most visible areas  
插頭穿過插孔後，將插頭最大限度地拉出，並平折成90度角。

▲ Insert tab and twist 90 degrees is best in some areas to ensure a tight connection  
插頭穿過插孔後，將插頭作90度旋轉扭曲，可在某些部位形成緊密的連接。

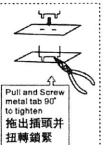

Schematic drawing of sheet metals (two pieces of sheet metals)  
金屬片示意圖 (有2片金屬)

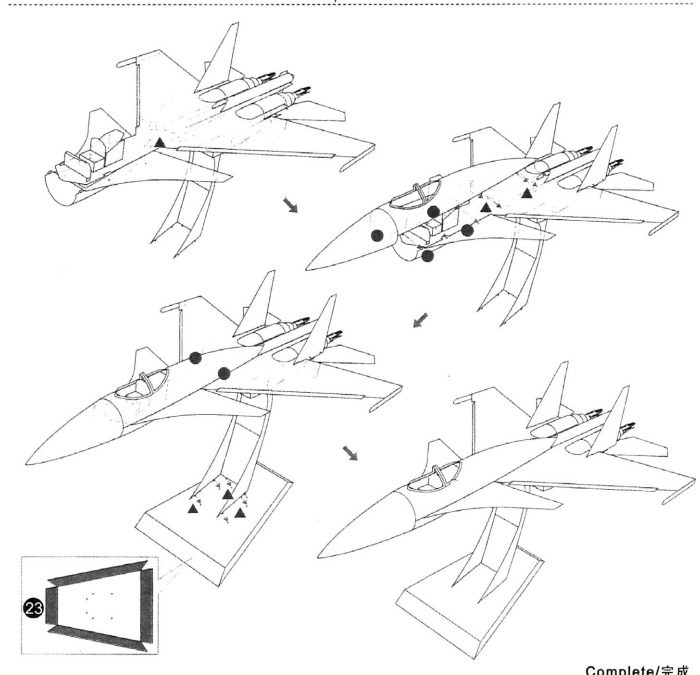
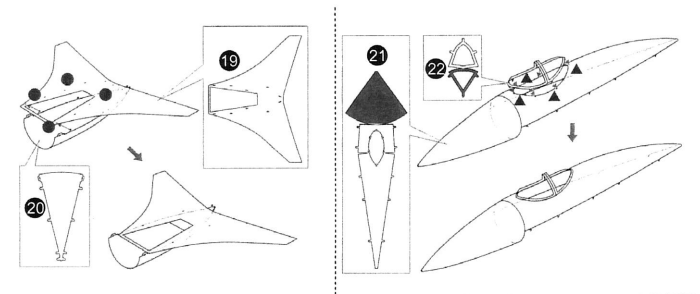
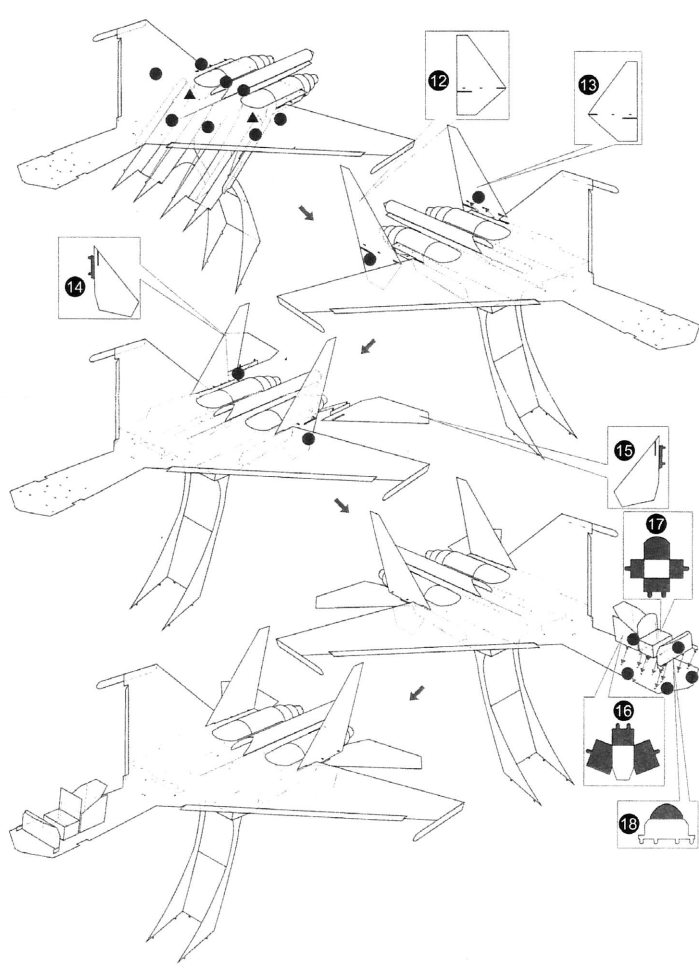
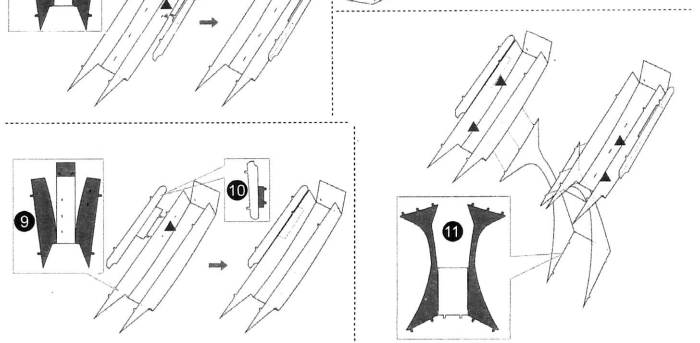
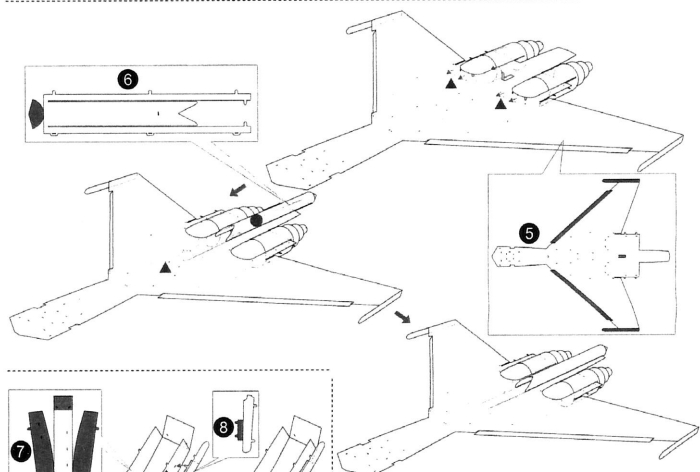
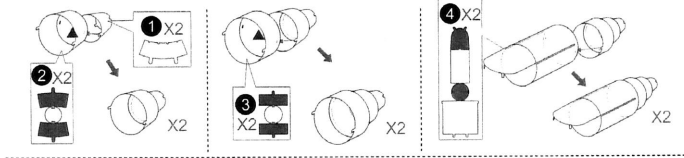
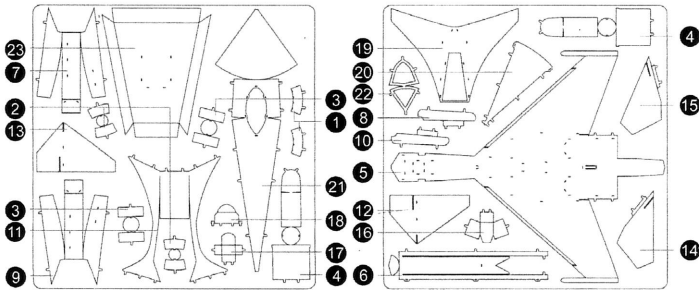

Complete/完成