

1/72 SCALE

F4F-3 "Wildcat"



EASY ASSEMBLY AUTHENTIC KIT



cyanoacrylate glue
强力胶



weight
配重



make hole
钻孔



cut / remove
切除



option
选择



no cement
不涂胶水



decal
贴纸



bend
弯曲

The way to apply the decals

1. Cut off the decal from the decal paper and put it into the warm water 40° for 10 seconds.
2. Take the decal from the water and put it on a piece of clean cloth.
3. Remove the decal slowly from the paper to the targeted location by a wet finger.
4. Use a piece of dry and soft cloth to press it gently on the decal until it getting dry and no bubble existing.

水贴纸的使用方法:

- 一. 把相关的印花从水贴纸上剪下, 放入40℃左右的温水中浸10秒。
- 二. 然后将印花放在干净的布上。
- 三. 拿上印花纸版, 手指蘸水将印花移到适当的位置。
- 四. 用软干布轻压印花直至水干, 气泡消失。

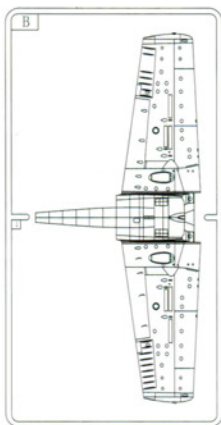
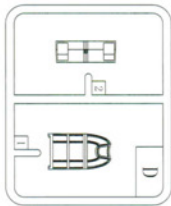
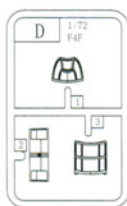
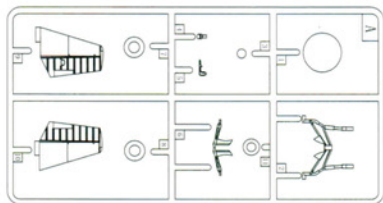

1

?
可选择
Option

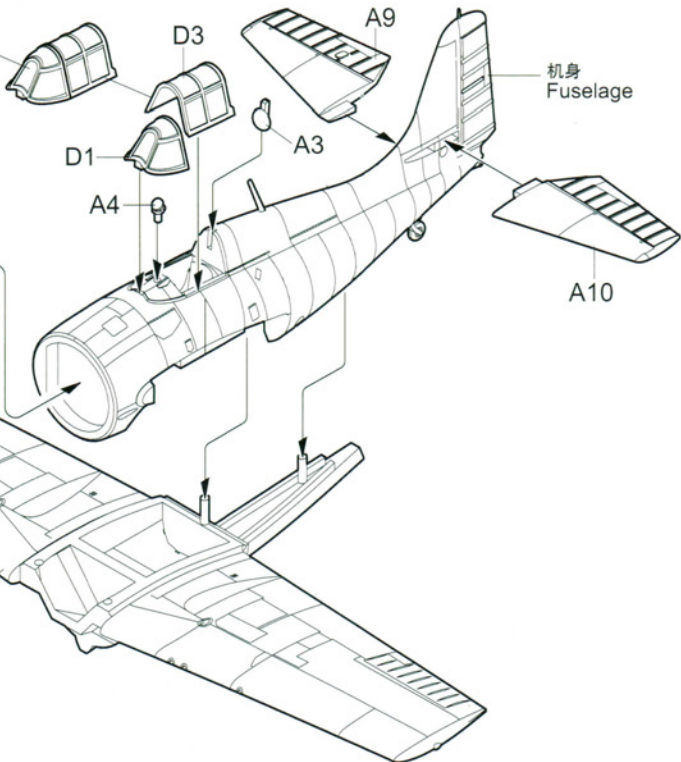

机身
Fuselage

机翼
Wing

2

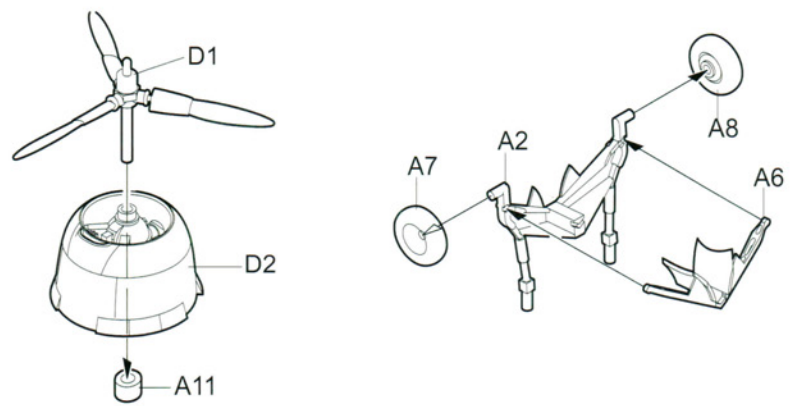

3

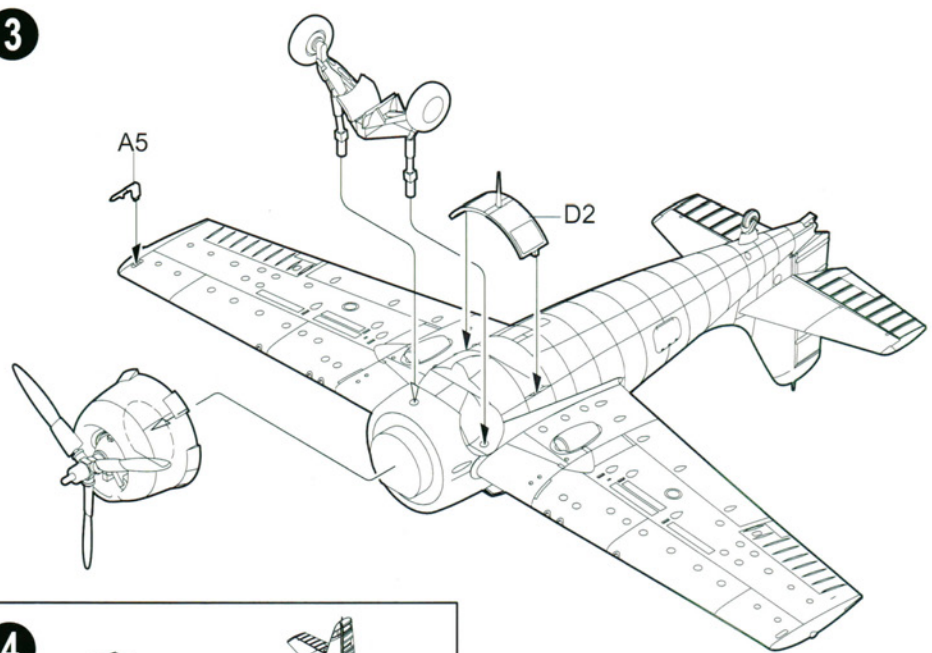

4

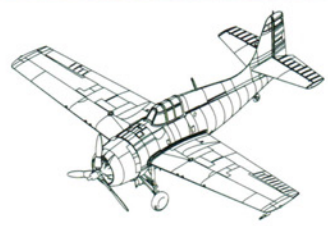

VF-41 USS RANGER Atlantic 1941

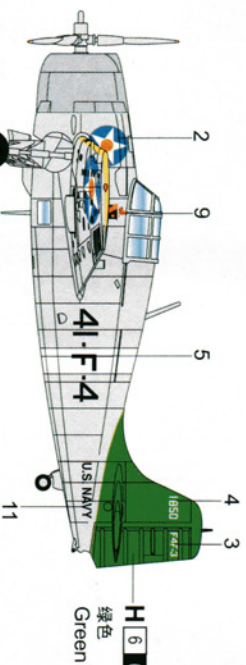

H 6 6
绿色
Green

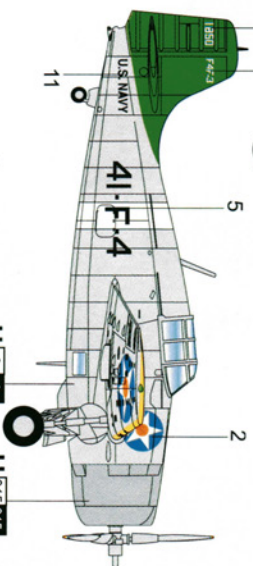

H 8 8
银色
Silver

H 315 315
灰色
Light Gull

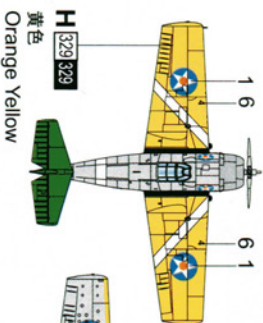

H 329 329
黄色
Orange Yellow

VF-3 aboard USS LEXINGTON

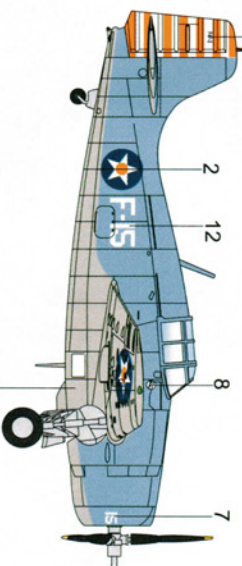
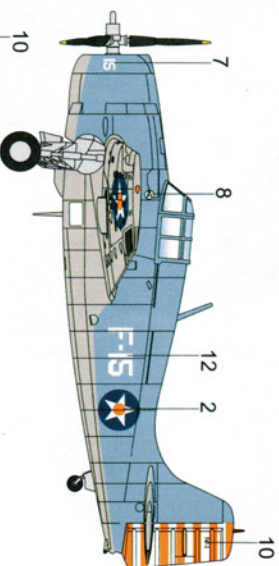

H 313 315
灰色
Dark Gull Grey

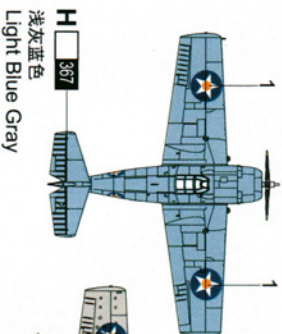

H 367
浅灰蓝色
Light Blue Gray

