

SCALE
1/48
USAF U-2S
"5th FS, Osan AB"



12307

Source of Photo : U.S. Air Force Webpage



PAINT INDEX	Humbrol		GSI Creos		Lifecolor	TESTORS / MODELMASTER		Revell		Vallejo		
	ENAMEL	MR. COLOR	AQUEOUS HOBBY COLOR	MR. COLOR		ENAMEL	ACRYL	ENAMEL	ACRYL	MODEL COLOR	MODEL AIR	
FLAT BLACK	33	33	H12	33	LC02	1749	4768	32108	36108	950	57	무광검은색
GRAY FS 36231	140		H317	317	UA033	1740	4755	32179	36179	991	159	회색
GLOSS RED	19	19	H3	3	LC56	1503	E2741	32131	36131	957	84	유광빨간색
YELLOW FS 13538	69	69	H4	4	LC53	1514		32310	36310	953		노란색
DARK GREEN	149		H302	302	UA008	1764	4729	32148	36148	895	14	녹색
WHITE FS 17875	22	22	H316	316	LC51	1745	4696	32104	36104	842		흰색
STEEL	53	53	H18	28	LC76	1795	4681	32191	36191	863	72	스틸
ALUMINUM	11	11	H8	8	LC74	1781	4677	32199	36199	993	62	알루미늄
SANDY YELLOW	84		H71	21	UA097	2052	4796	32116	36116	821	31	노란색
CLEAR RED	91321		H90	47			4630			934		투명빨간색
CLEAR BLUE	91320		H93	50			4658			938		투명파란색

점착제 사용. Cement parts Color Kleben	점착제 사용하지 않습니다. Do not cement Ne pas coller Nicht kleben	중간을 반복합니다. Repeat operation Répéter l'opération Vorgang wiederholen	데칼을 붙입니다. Decals Decalomanies Abziehbild	무게를 넣습니다. Add weight Lester Gewicht	구멍이나 홈을 채웁니다. Painting scheme number Masquage Schleifen
공작합니다. Cut away Cusper Schneiden	선택합니다. Optional parts Choix Auswahlmöglichkeit	반대쪽도 반복합니다. Repeat for opposite side Répétition de la page Wiederholung für gegenüberliegende Seite	구멍을 뚫어줍니다. Make holes Faire un trou Öffnen	주의합니다. Be careful Faire attention Hier Vorsicht	색칠 및 데칼이 붙기 전 번호 Painting scheme number Numéros de la liste de peintures Lackierschemanummer

<READ THIS BEFORE YOU BEGIN>

- Study the instructions before assembling. Check the fit of each piece before cementing it into place.
- Do not use too much cement to join parts. Never use cement or paint near open flame.
- Open a window or make area well ventilated when cement or paint is in use.
- Tear up and throw away the empty plastic bags to avoid danger of suffocation for little children.

<ALLGEMEINE HINWEISE>

- Die Anordnung der Bauteile ist aus den Zeichnungen der Anleitung ersichtlich.
- Die Teile vor dem Verkleben ungekürzt zusammenhalten, um ihren paßsatz zu prüfen.
- Nichtstift nicht zu dick auftragen. Klebstoff und Farben niemals in der Nähe einer Flamme verwenden.
- Während der Bemalung mit Spritzpistole oder Pinsel für frische Luftzufuhr, z.B. öffnen des Fensters, sorgen.
- Bausatz von kleinen Kindern fernhalten. Verhüten Sie, daß Kinder irgendwelche Bauteile in den Mund nehmen oder Plastiktüten über den Kopf ziehen.



CAUTION

<READ THIS BEFORE YOU BEGIN>
<LISEZ CE QUI SUIT AVANT DE COMMENCER LE MONTAGE>
<읽기 전에 주의>
<BEZECI OVAZ POCETI PRADZET>
<BEZECI OVAZ EN POCETI PRADZET>

<LISEZ CE QUI SUIT AVANT DE COMMENCER LE MONTAGE>

- Etudier les schémas d'assemblage. Vérifier que chaque pièce soit bien conforme avant de la coller à sa place.
- N'utilisez pas trop de colle pour joindre les pièces. Ne jamais manipuler la colle ou la peinture à proximité d'une flamme.
- Aérer soigneusement la pièce si vous peignez/jouez la peinture.
- Après avoir sorti les pièces du sac en plastique, déchirer le sac afin d'éviter que les enfants ne le mettent sur la tête et ne s'étouffent.

<읽기 전에 주의>

- 組み立て前に図解書をお読み下さい。各パーツが取り付けられる部分と型紙型カラーシートとカラーを照合します。
- 接着剤を少なからず塗り、塗りすぎた場合は拭き取して下さい。接着剤や塗料を炎のそばで乾燥させないでください。
- 塗料を乾燥させる際は新鮮な空気を取り入れるように換気をお願いします。
- 組み立てた模型がビニール袋に入らない子供の手の届かない安全な場所に保管して下さい。

■ 조립하기 전에

- 부품을 조립하기 전에 설명서를 잘 읽어본 후 조립한다. -부품을 자를 때에는 칼이나 나이프를 깨끗이 갈라준다. -점착제를 사용할 곳과 사용하지 않는 곳에 주의하고 너무 많이 바르지 않도록 한다.
- 점착제나 색칠이 잔여 부품을 맞추어 확인한 후 조립한다. -에어건을 깨끗이 하고 점착제를 사용할 때는 청소를 많이 행하고 화기를 갈라준다. -사용 후 남은 부품을 어린 아이들이 손에 닿지 않도록 잘 치운다.

1 

Instrument Panel
(계기판)

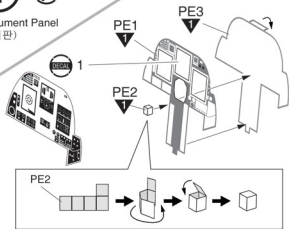

※ Use instant glue when attaching.
순간접착제로 붙인다.

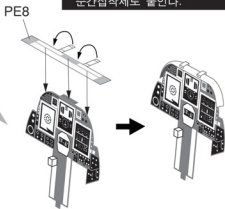

2 

Cockfit (콕핏)
Landing gear bays (랜딩 기어 베이)

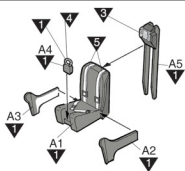
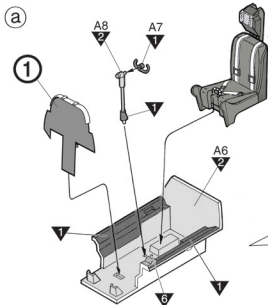

Top View
상면도

※ Use instant glue when attaching.
순간접착제로 붙인다.

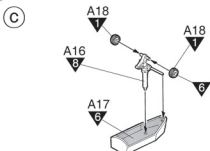
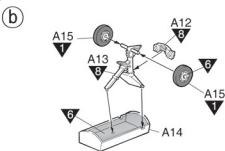
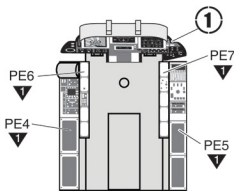

3 

Fuselage (동체)
Canopy (캐노피)

 **2**
Marking scheme ② only.
도장도 ②의 기체에만 구멍을 내줍니다.

Inside
내측

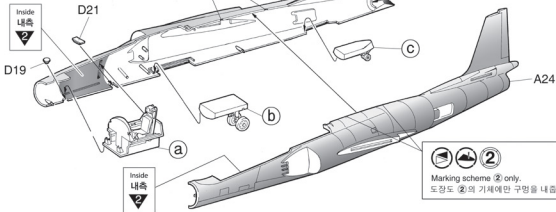



 **2**
Marking scheme ② only.
도장도 ②의 기체에만 구멍을 내줍니다.

PE10

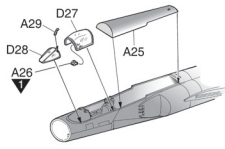

PE9



4 

Senior SPAN (시니어 스팬)
Horizontal stabilizer (수평 꼬리 날개)
Air Intake (에어 인테이크)
Wings (주익)

Senior SPAN
 **2**
Marking scheme ② only.
도장도 ②의 기체에만 조립하십시오.

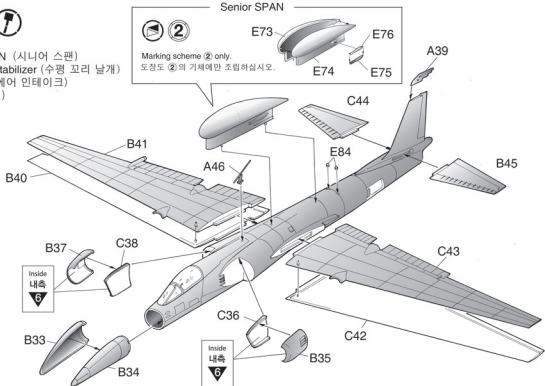

Inside
내측

Inside
내측

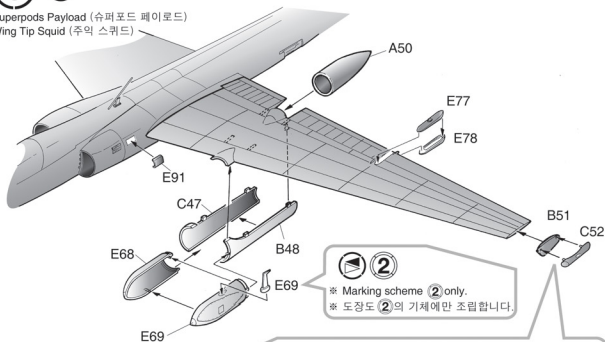

5 

Superpods Payload (슈퍼포드 페이로드)
Wing Tip Squid (주익 스쿼드)

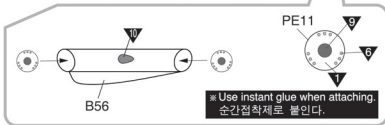

 **2**

* Marking scheme **2** only.
* 도장도 **2**의 기체에만 조립합니다.



* Use instant glue when attaching.
순간접착제로 붙인다.

6 

Superpods Payload
Wing Tip Squid

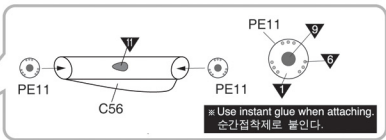

* Use instant glue when attaching.
순간접착제로 붙인다.

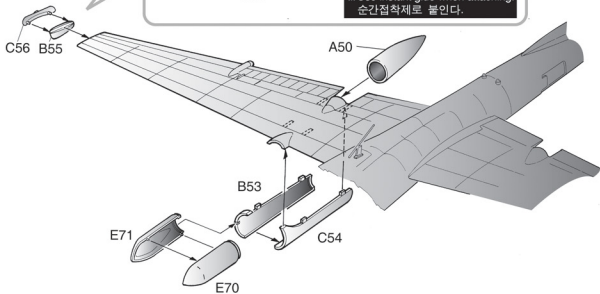

7

Pogos (보조 랜딩 기어)
Air Break (에어 브레이크)
Sensors (센서류)

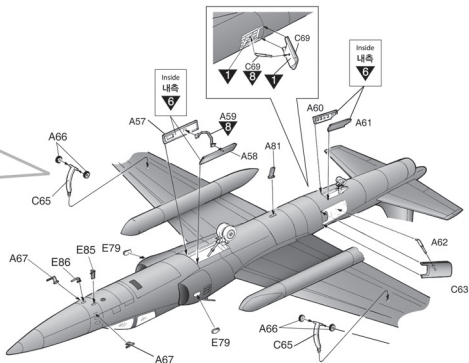
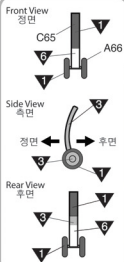

8

※ Marking scheme ② only.
※ 도장도 ②의 기체에만 조립합니다.

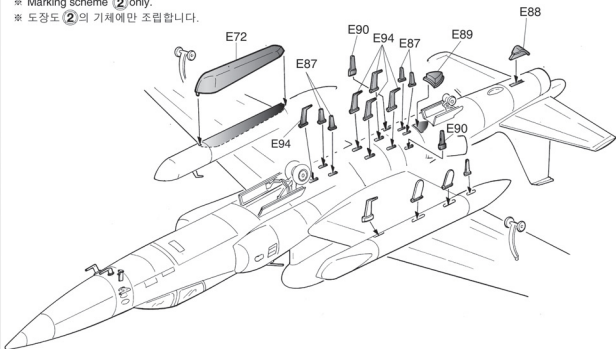

- ① USAF U-2S 80-1084(C/N 084), Osan Air Base (K-55, OSN/RKSO), South Korea, October 2012.
미공군 U-2S 80-1084(C/N 084), 2012년 10월 대한민국 오산 공군기지.

Body color : ▼ Flat Black

기체 색 : ▼ 무광 검은색

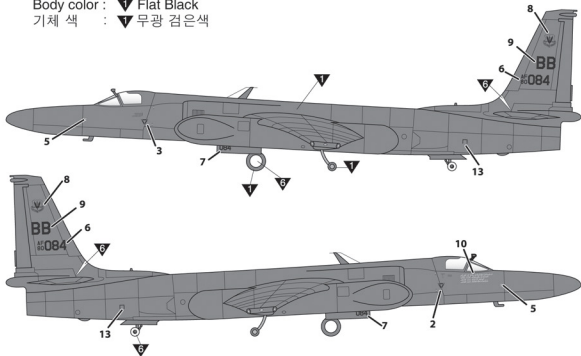

- ② USAF U-2R 80-1084(C/N 084), Fairford (FFD / EGVA), UK - England, July 2005.
미공군 U-2R 80-1084(C/N 084), 2005년 7월 영국 페어포드 공군기지.

Body color : ▼ Flat Black

기체 색 : ▼ 무광 검은색

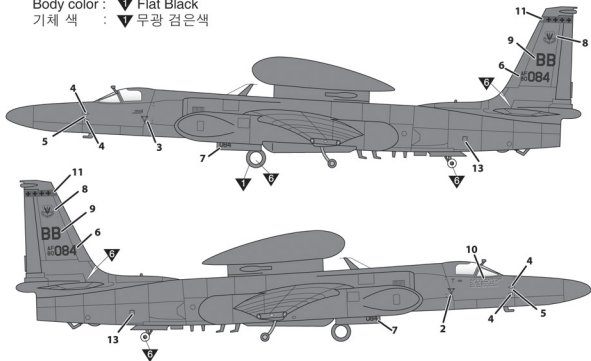

● COMMON DATA

공통데이터

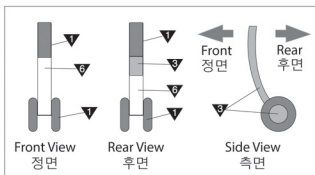
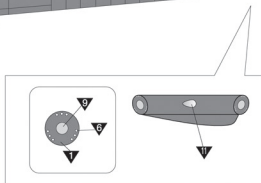
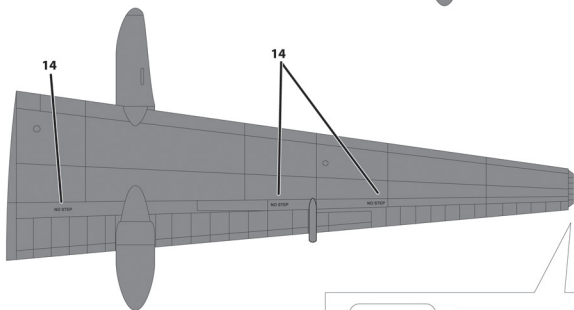
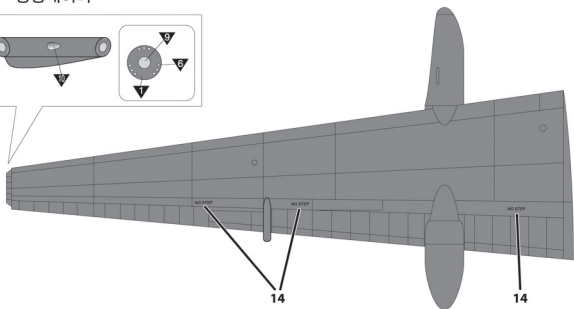
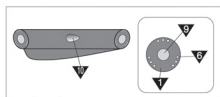

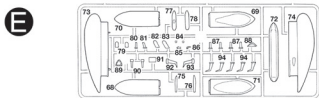
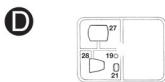
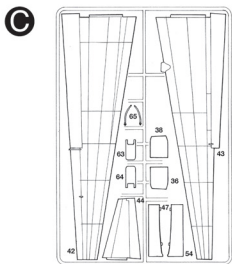
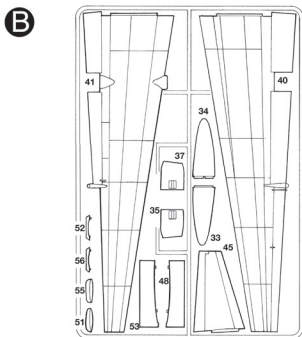
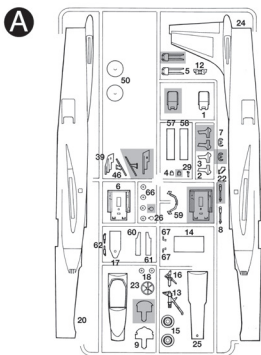

• Photo Etched Parts / 에칭파트

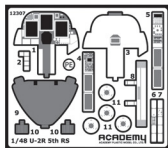

• Decal / 전사지

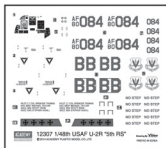

• Unused parts / 불필요 부품

A1, A2, A3, A4, A5, A7, A8, A9
A10, A11, A22, A26, E73, E74, E75
E76, E79X2, E80, E82, E83, E87X4
E92, E93, E94X5