

# ISRAELI SKYHAWKS

Defenders of the Holy Land 1968 - 2015

1/48 decal set - 25 marking options, all variants, all squadrons

**W** A-4E No. 215, 116 Squadron „The Flying Wing”, 1973

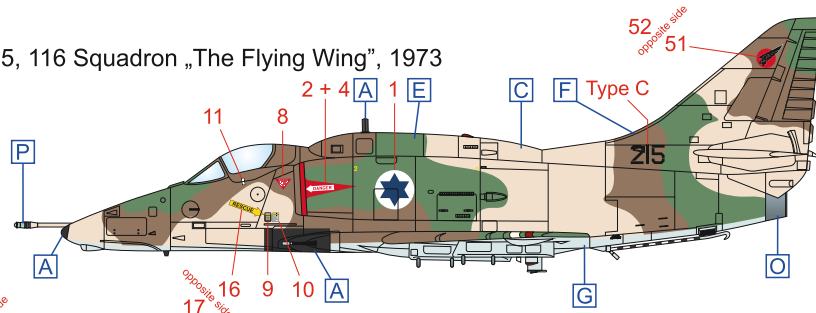

**X** A-4N No. 322, 115 Squadron „The Flying Dragons”, 1973

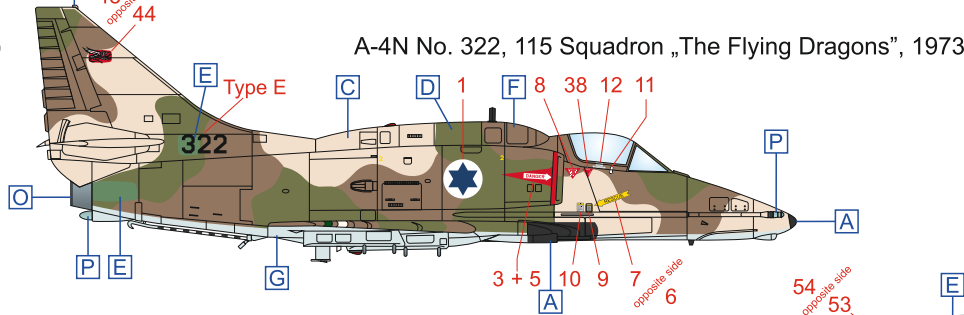

**Y** A-4E No. 899, 140 Squadron „The Golden Eagle”, mid 1970s

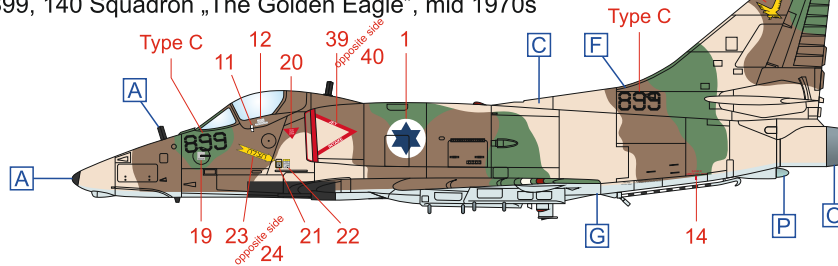

**Used colours:**

		GUNZE SANGYO Mr. COLOR	
A	BLACK MATT	FS 37038	33
B	WHITE	FS 17875	1
C	SAND	FS 33531	313
D	GREEN	FS 34258	312 + 304
E	PALE GREEN	FS 34227	312
F	TAN	FS 30219	310
G	LIGHT BLUE	FS 35622	314
H	LIGHT GREY	FS 36375	308
I	RED	FS 11136	3
J	BLUE		5
K	YELLOW	FS 23538	4
L	SIGNAL RED	FS 12197	79
M	LIGHT GREEN	RLM 82	122
N	GREY	FS 35237	337
O	JET EXHAUST		MC 214
P	STEEL		MC 213

Recommended kits:  
 - Hasegawa A-4E/F, A-4E/H  
 - Hasegawa A-4M, A-4N  
 - Hasegawa TA-4J

More products you can see  
 on our webpage:

[www.armycast.cz](http://www.armycast.cz)

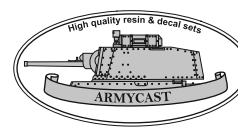
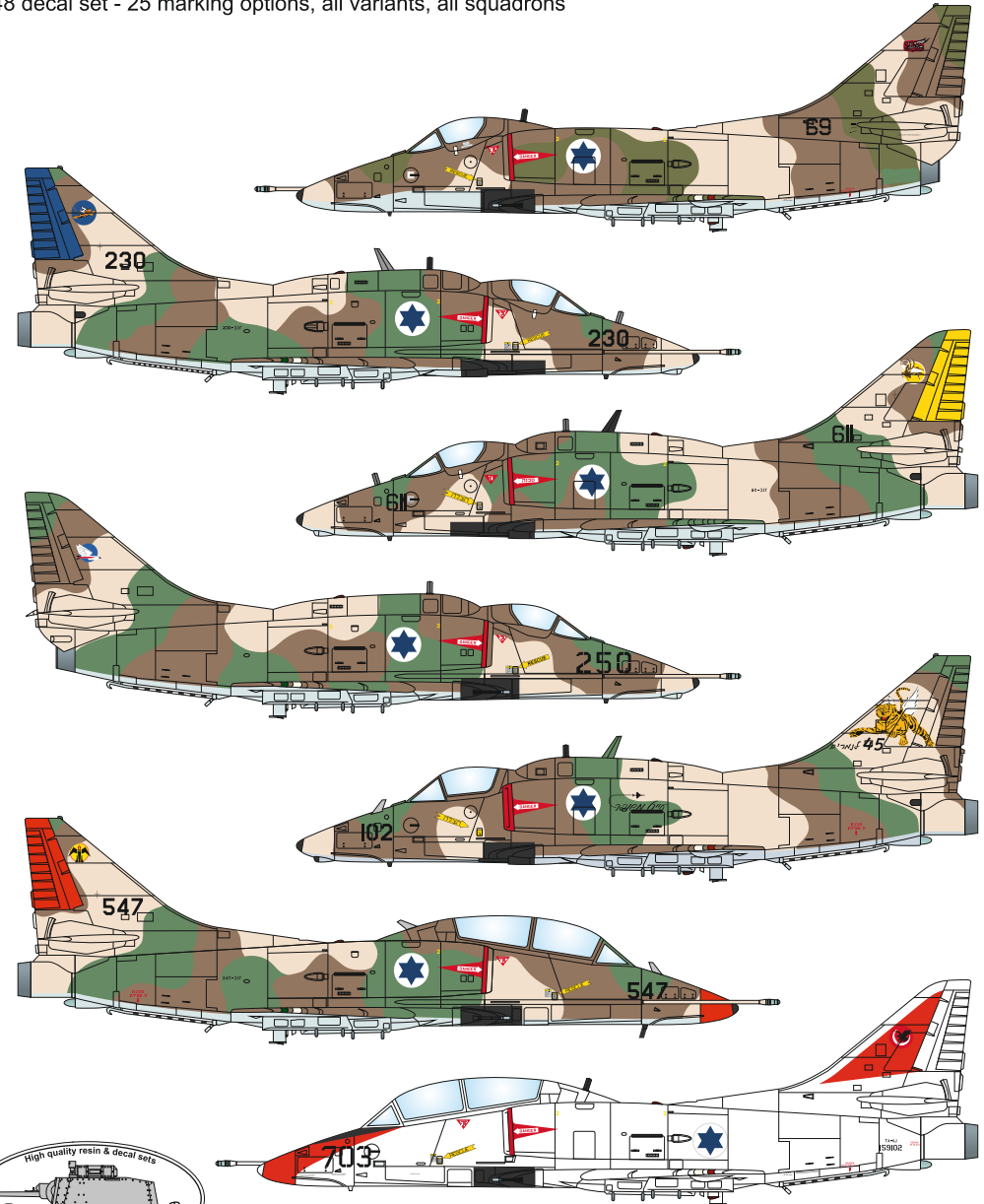

**A** A-4H No. 09, 109 Squadron „The Valley”, 1968

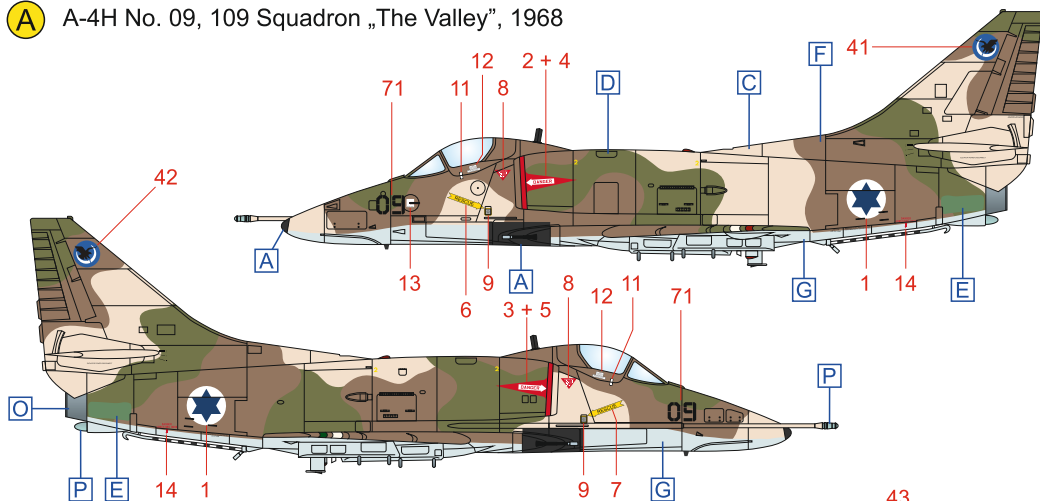

**B** A-4H No. 69, 115 Squadron „The Flying Dragons”, 1969

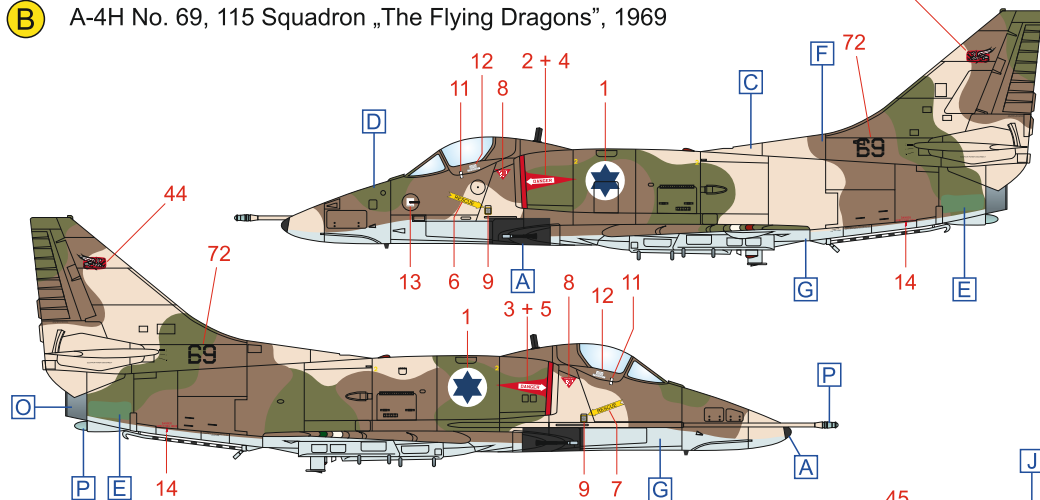

**C** A-4H No. 230, 102 Squadron „The Flying Tigers”, early 1990s

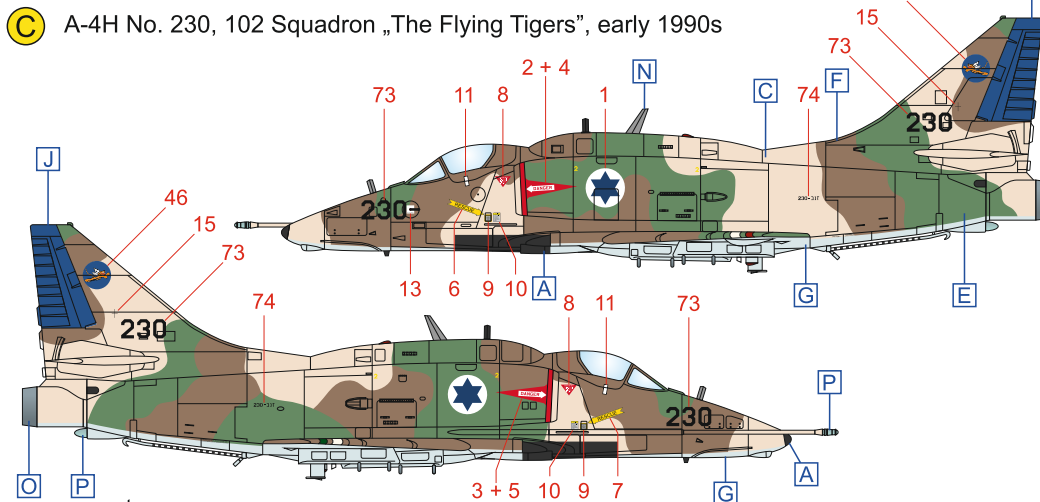

**R** A-4E No. 866, 149 Squadron „The Smashing Parrot”, late 1970s

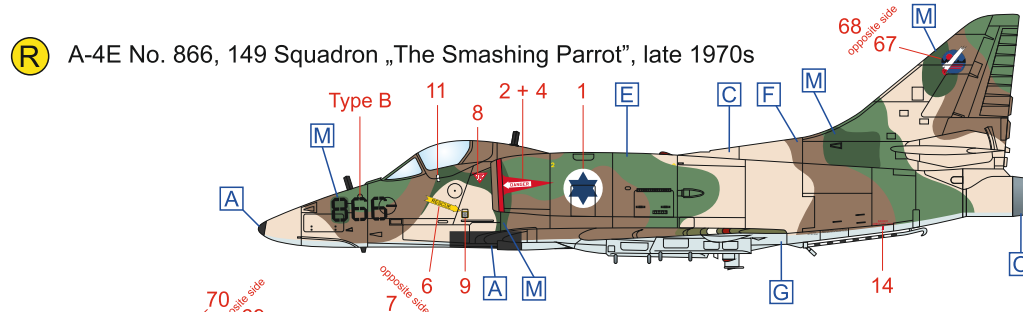

**S** TA-4F No. 566, Flight School Unit, October 1973

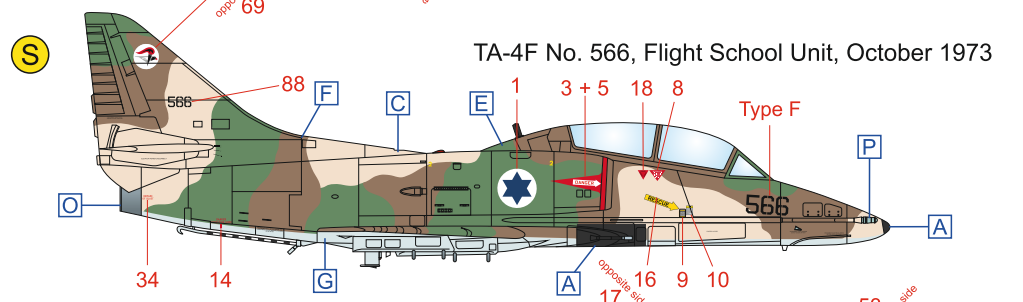

**T** TA-4J No. 723, 140 Squadron „The Golden Eagle”, 1973

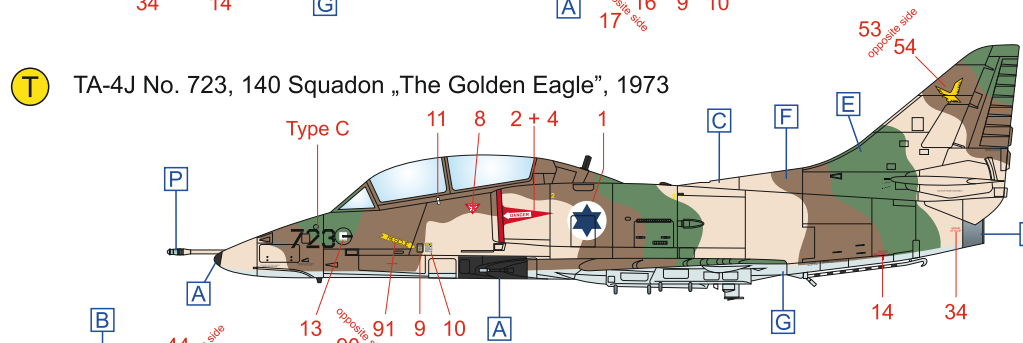

**U** TA-4J No. 726, 115 Squadron „The Flying Dragons”, mid 1970s

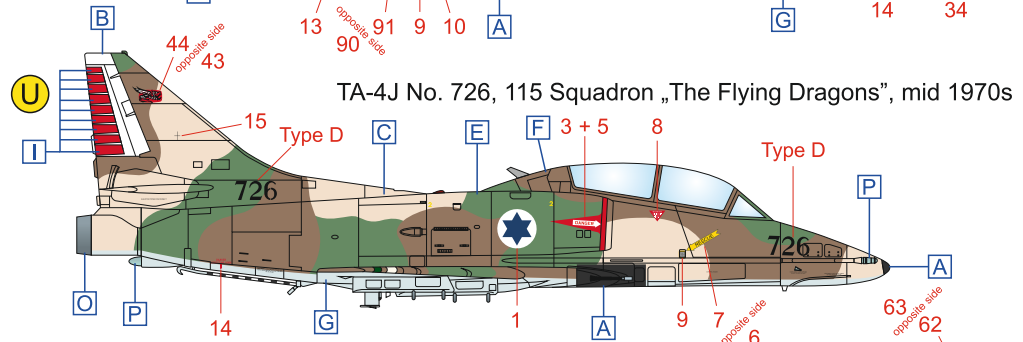

**V** A-4N Meshopar No. 336, 102 Squadron „The Flying Tigers”, 2012

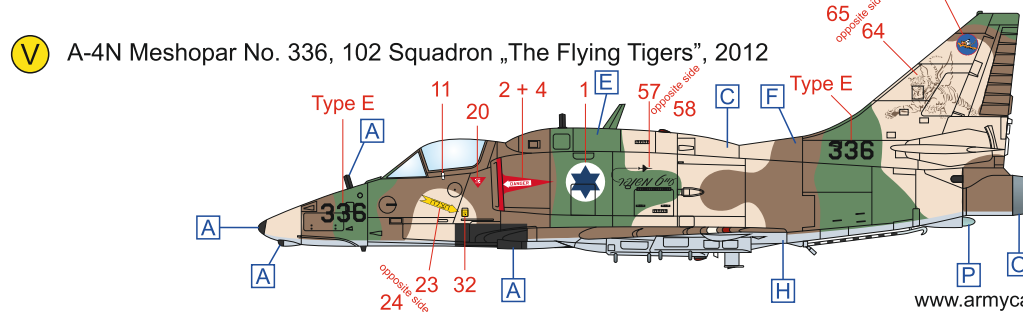

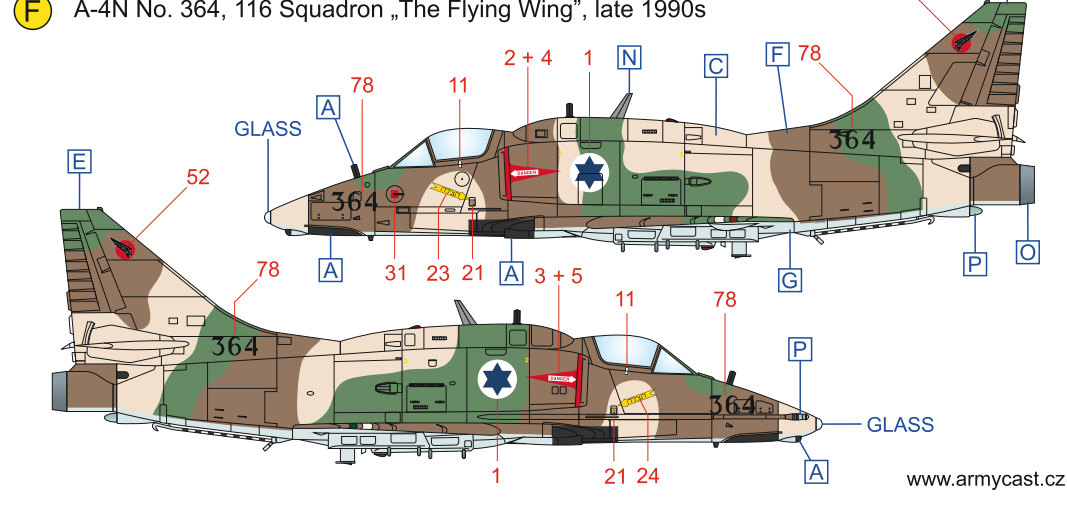
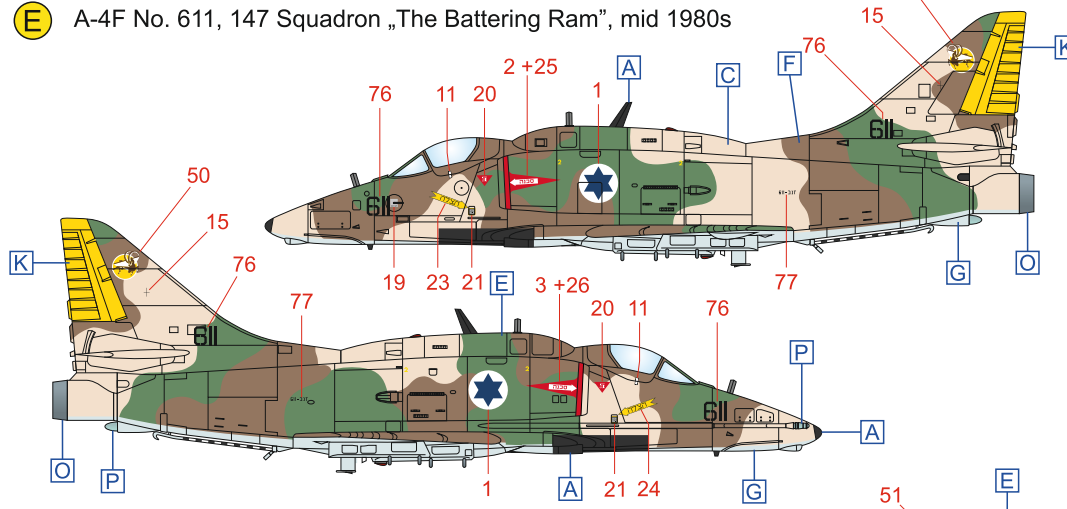
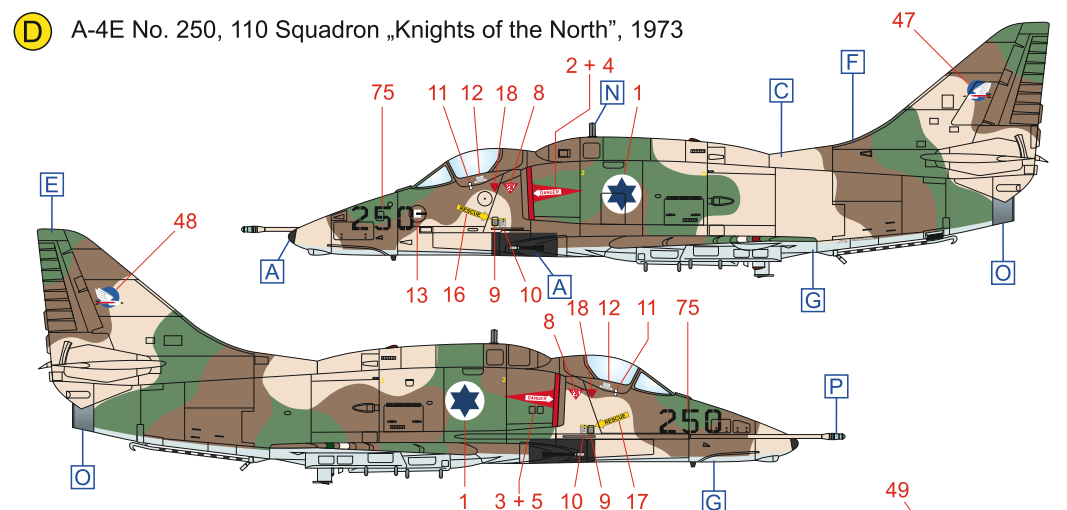
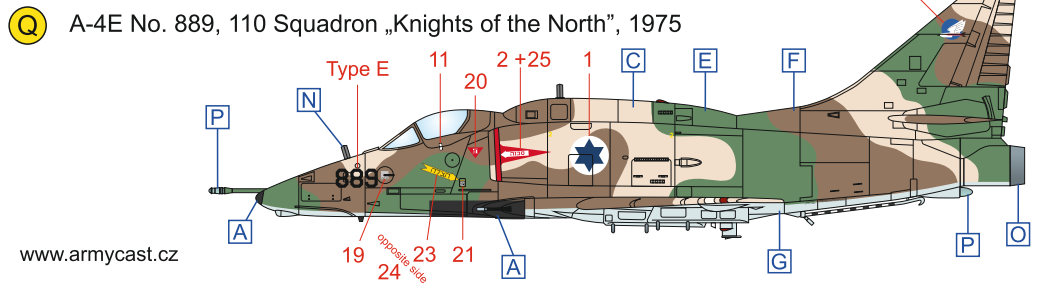
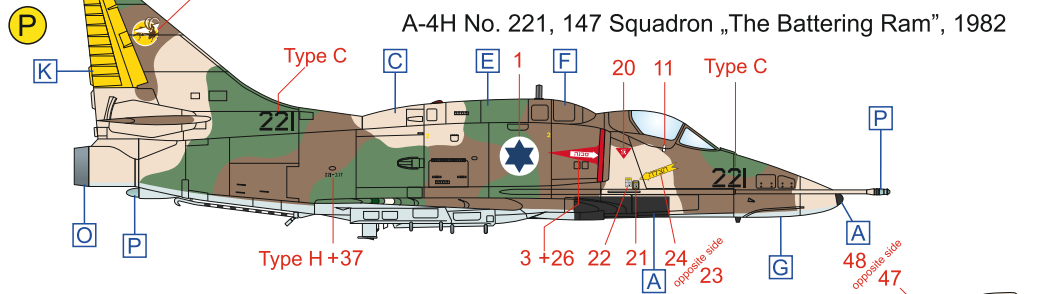
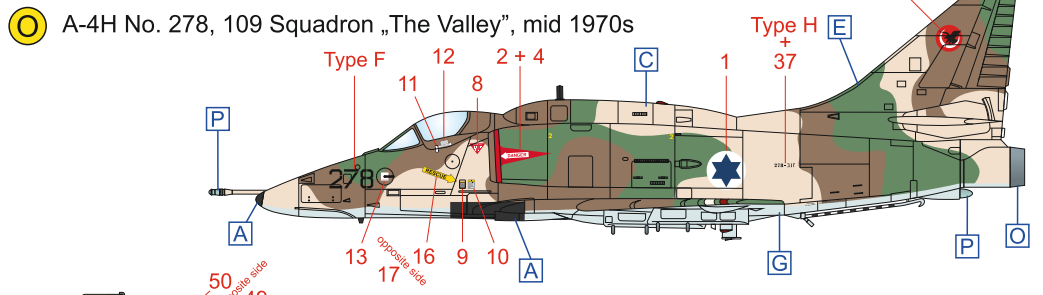
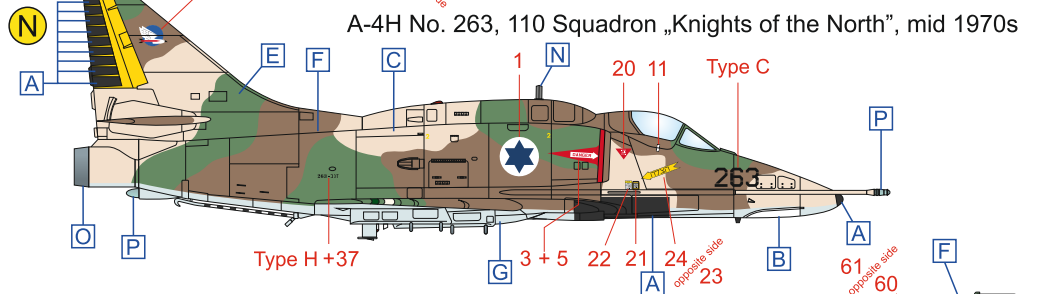
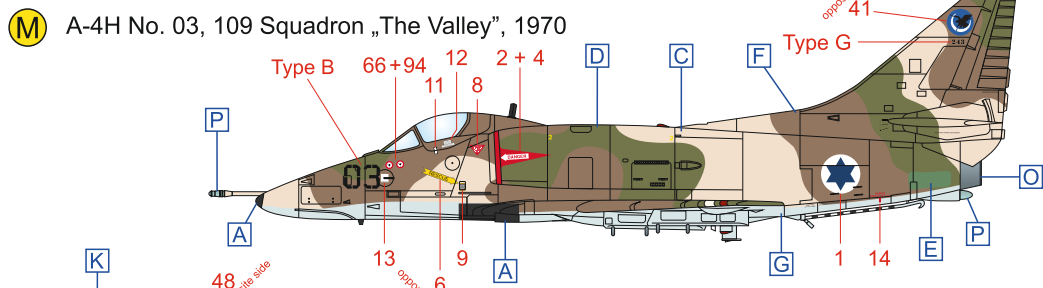



**G** A-4N No. 413, 140 Squadron „The Golden Eagle”, 1982

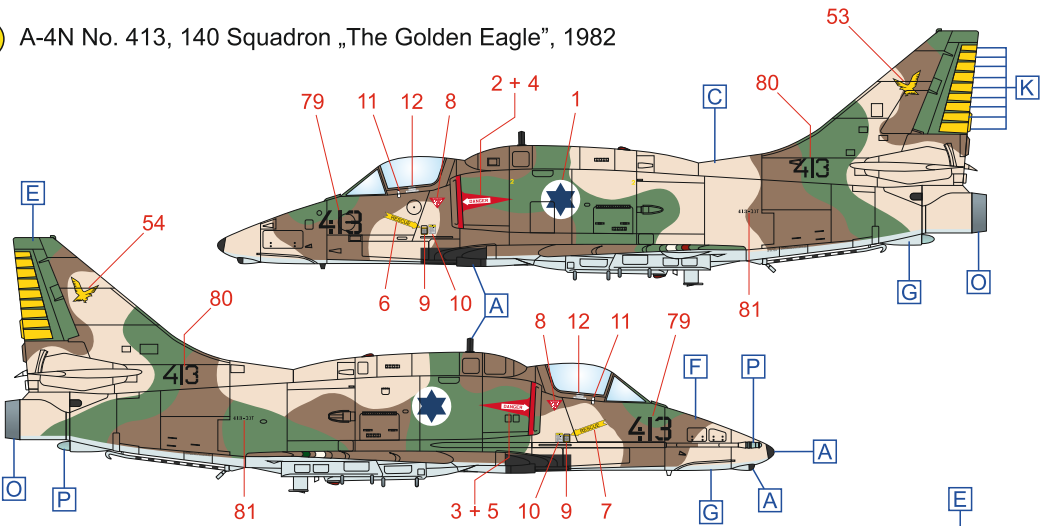

**J**

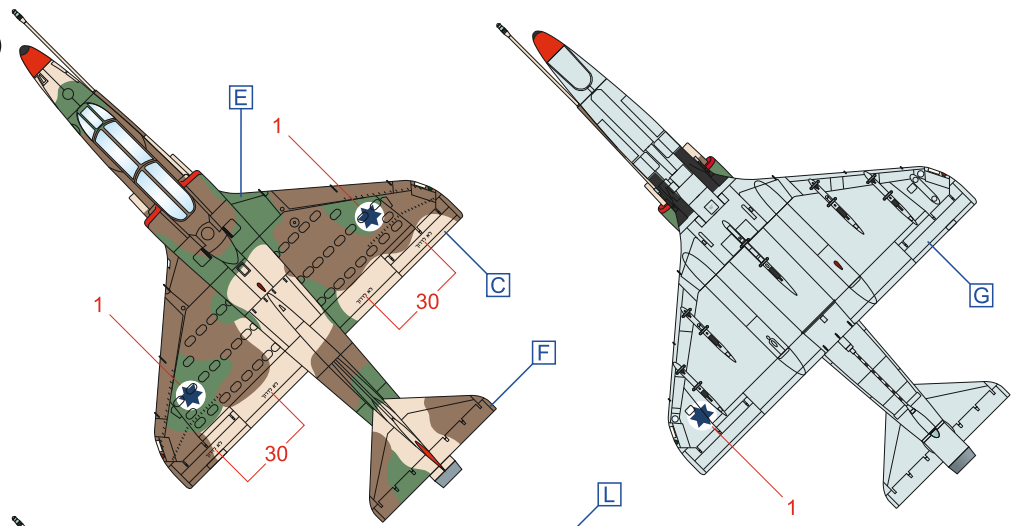

**H** A-4N Meshopar No. 102 (332), 102 Squadron „The Flying Tigers”, 2014

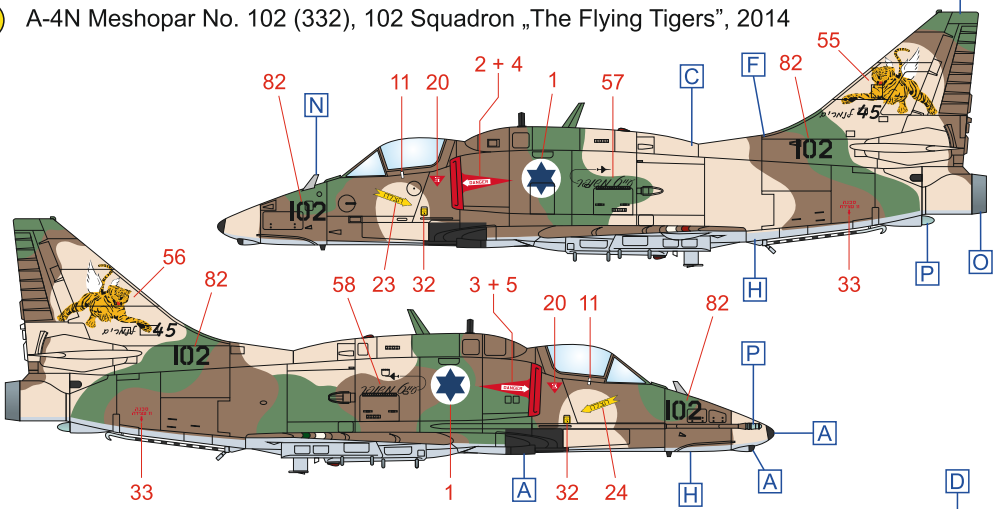

**K**

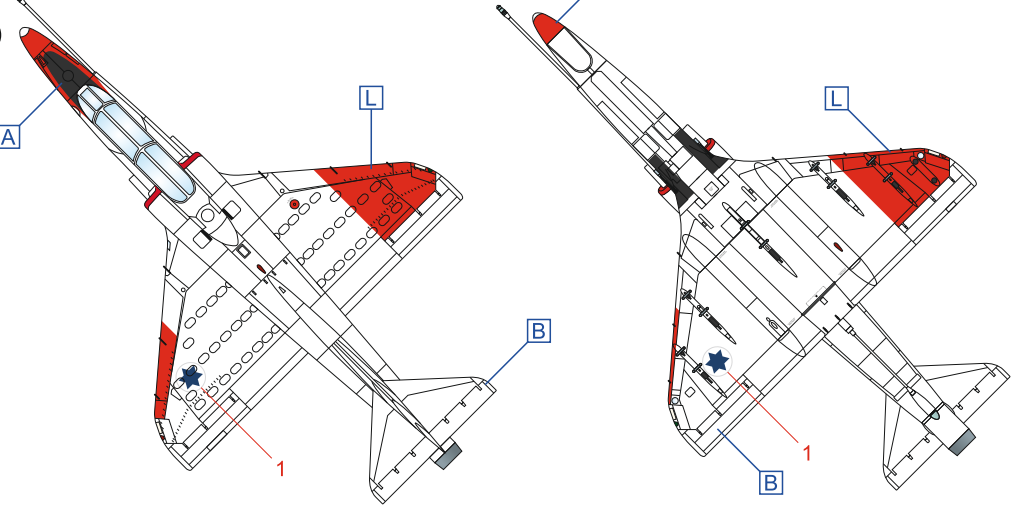

**I** TA-4H No. 145, 109 Squadron „The Valley”, early 1970s

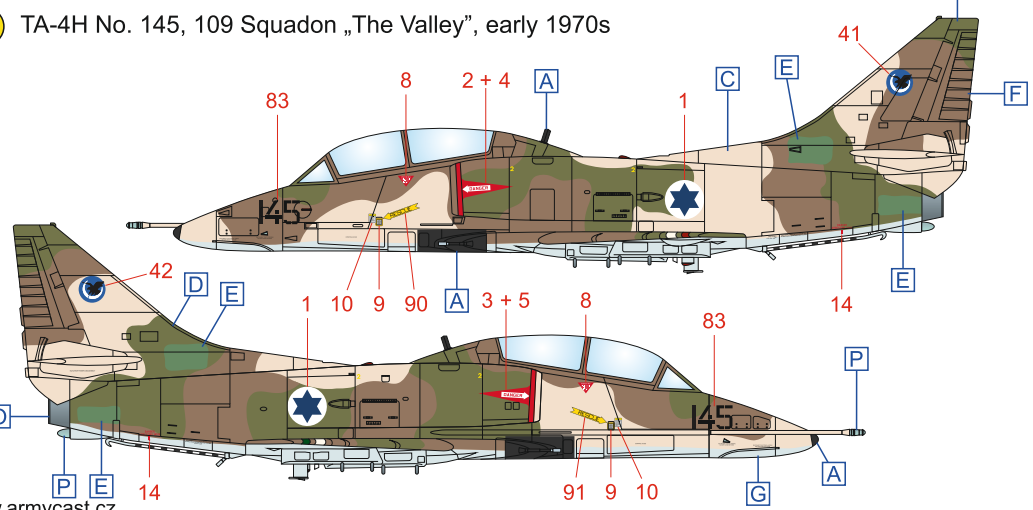

**L**

