

How to put your model together / Mode d'assemblage de votre modèle.
 Anweisungen für den Zusammenbau des Modells / Methode voor het
 in elkaar zetten van Uw model / Så här sätter Du ihop modellen / Per
 montare il vostro modello / Näin kootaan malli.

Symbols used in assembly diagrams / Symboles employés sur les diagrammes d'assemblage.
 In den Zusammenstellungsskizzen verwendete Zeichen / Tekens die in de monteringsdiagramm-
 en gebruikt worden / Teckenförklaring till sammanfogningsdiagram / Simboli usati nello
 schema de montaggio / Asennuskuvioissa käytettyjen merkkien selitykset.



Cement parts together.
 Coller les pièces ensemble.
 Teile zusammenkleben.
 Cementeer de delen samen.
 Limma ihop delarna.
 Cementare le parti l'una con l'altra.
 Osat liimataan yhteen.



Do not cement together.
 Ne pas coller ensemble.
 Nicht zusammenkleben.
 Cementeer niet samen.
 Limma inte ihop delarna.
 Non cementare le parti.
 Osia ei liimata yhteen.



Choice of parts provided.
 Choix de pièces fournies.
 Mitgelieferte Auswahl an Teilen.
 Keuze van beschikbare onderdelen.
 Dessa delar medföljer för valfri användning.
 Particolari a scelta.
 Osien käyttö valinnanvaraista.



Cut with a sharp knife.
 Couper avec un couteau tranchant.
 Mit einem scharfen messer schneiden.
 Snijd met een scherp mes.
 Skär med en skarp kniv.
 Tagliare con un coltello ben affilato.
 Leikatkaa terävällä veitsellä.



Shape with a hot knife.
 Former au canif chaud.
 Mit einem heißen Messer formen.
 Vorm met een heet mes.
 Forma med varm kniv.
 Modellare con la lama di un coltello riscaldato.
 Muovattaa kuumalla veitsellä.

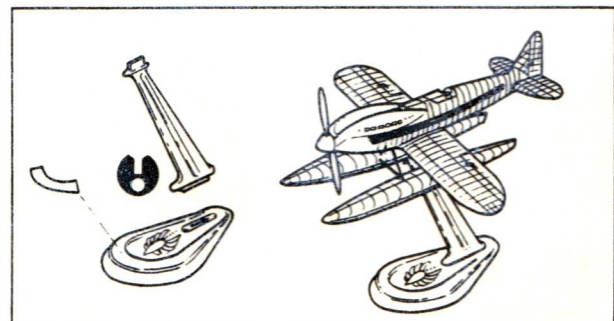
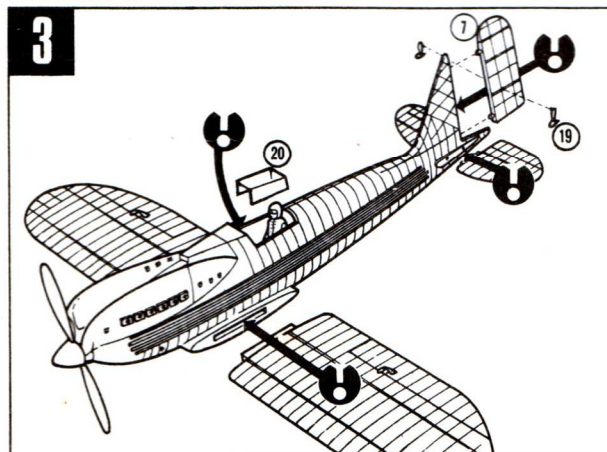
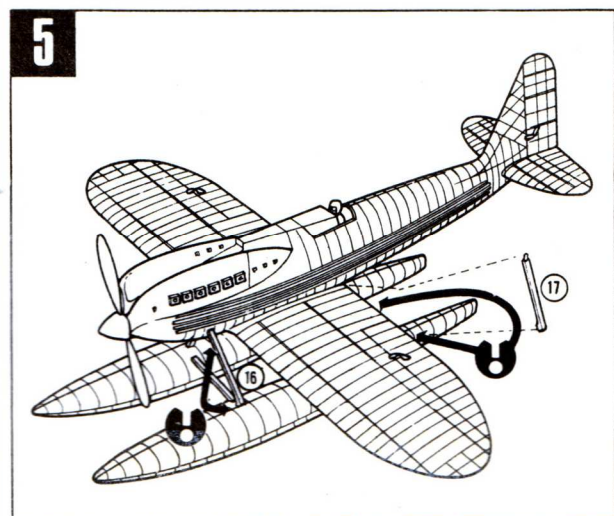
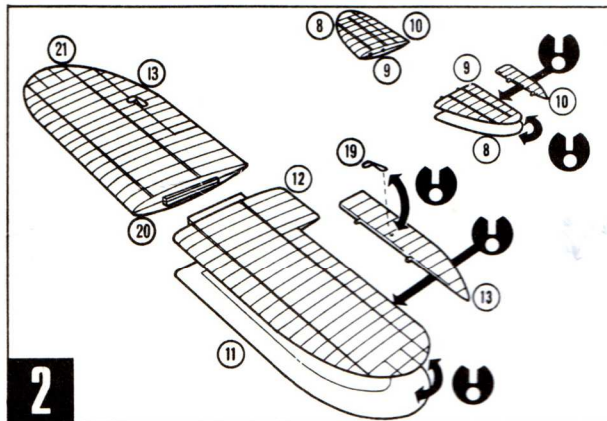
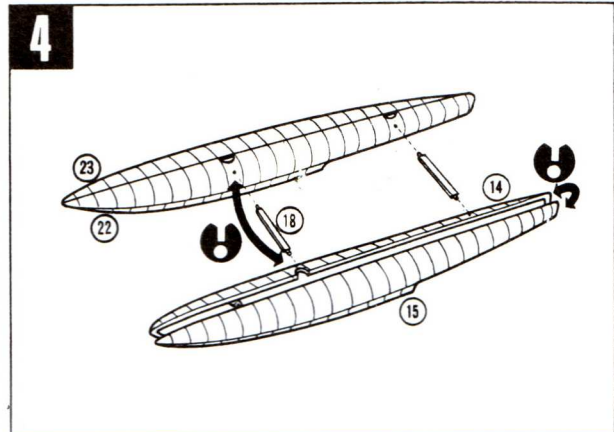
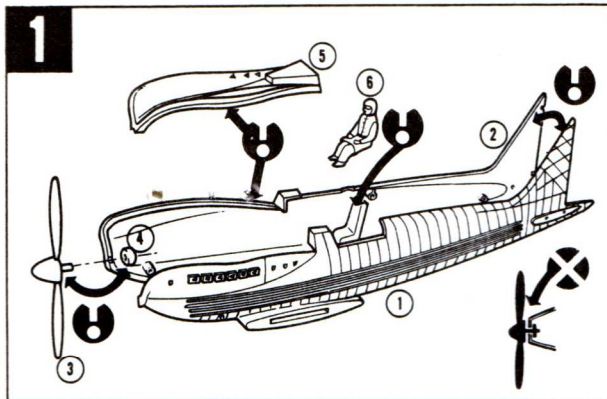

Aircraft Colour Guide

SUPERMARINE S6B

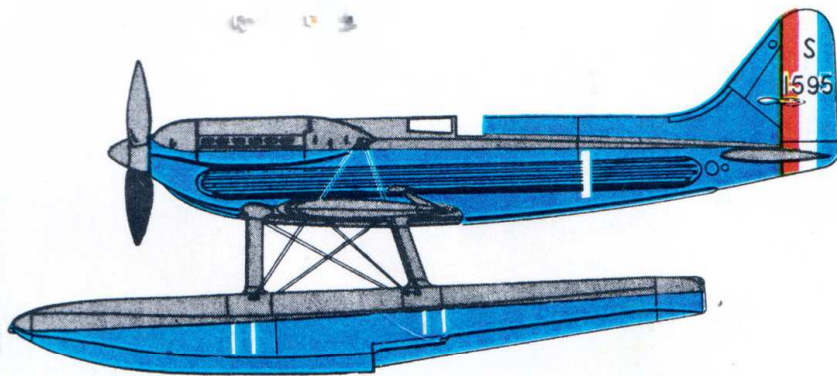

On 13th Sept. 1931, Flt Lt J.N. Boothman, flying S1595, won the coveted Schneider Trophy outright for Great Britain at an average speed of 340.08mph. On 29th Sept. 1931, Flt Lt G.H. Stainforth flew S1595 at an average speed of 407mph to gain the World Airspeed Record for Great Britain.

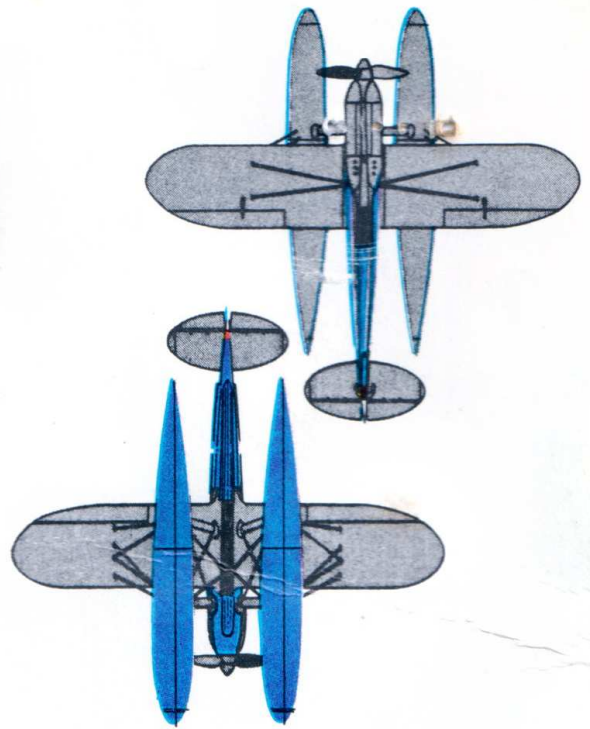

Made in Great Britain



Multi lingual assembly pictures! Includes parts and markings for one model!



Gemakkelijk te volgen Nederlandse instructies. Bevat onderdelen en merktekens voor één model!



Übersichtliche deutsche Zusammenbauanleitung. Enthält Teile und Markierungen für ein Modell!



Instructions faciles à suivre en Français. Comprend pièces et décorations pour un modèle!



Instruktioner på svenska. Innehåller delar och emblem för en modell!



Suomenkieliset ohjeet. Sisältää yhden mallin osat ja tunnukset!



Istruzioni in Italiano facili da eseguire. Parti e insegne per un modello sono incluse!