

Boeing Sea Knight

mpe
78 - 4102 - 250

This distinctive twin-rotor helicopter made its first flight in prototype form on 22nd April, 1958, under the designation Model 107. It was designed for water landing capability, without the addition of special floatation gear or boat hull design, and intended for commercial and military use. In 1961, the United States Marine Corps placed an initial order for the 107, designated CH-46A Sea Knight. The primary role of this version is assault, carrying a crew of three and 17-25 fully-equipped troops over a combat radius of 115 miles (185 km) at 150 m.p.h. (240 km/h).





ships, UH-46As transfer ammunition, missiles, aviation spares and general supplies up to 8,000 lb (3 628 kg), day or night, to fighting ships under way at sea. Sea Knights can also perform search and rescue missions, target drone recovery and plane guard duty. The type operated successfully in the Vietnam war and other versions have been bought by Canada, Japan and Sweden. Sea Knight is powered by two 1,250 shaft horse power General Electric T38 engines. Length over rotors 83 ft 4 in (25.40m).

An urgent requirement for ship replenishment at sea prompted the U.S. Navy to order Sea Knights and the first UH-46As were delivered in 1964. Operating from fast combat supply

Markings are provided for a U.S. Navy UH-46A Sea Knight of Utility Helicopter Squadron One (HC-1) attached to the Fast Combat Support Ship USS "Sacramento".

IMPORTANT! READ THIS FIRST

- Study assembly drawings carefully before starting.
- Each part is identified by a part number (14).
- Scrape paint from areas to be cemented.
- Before cement is used, check the fit of each part.
- Use only enough cement to join parts.
- Apply cement to small parts with a toothpick.
- Use cement made for styrene plastic only.
- Allow paint to dry thoroughly before handling.
- Your model may be painted to match the box photos.
- Cement all parts except where Do Not Cement symbol  is shown.
- Follow the step numbers ● in each assembly drawing.
- * Refer to other assembly drawing for location.
- Refer to last page for decal and painting instructions.

- 5 — STEP NUMBERS
- 32 — PLASTIC PART NUMBERS
-  — OPTIONAL
-  — DO NOT CEMENT
-  — CEMENT HERE ONLY
- 2X — REPEAT SEVERAL TIMES
-  — REMOVE
- ★ — REFER TO ...
-  — DECAL

© 1982 Fundimensions, Division of CPG Products Corp.

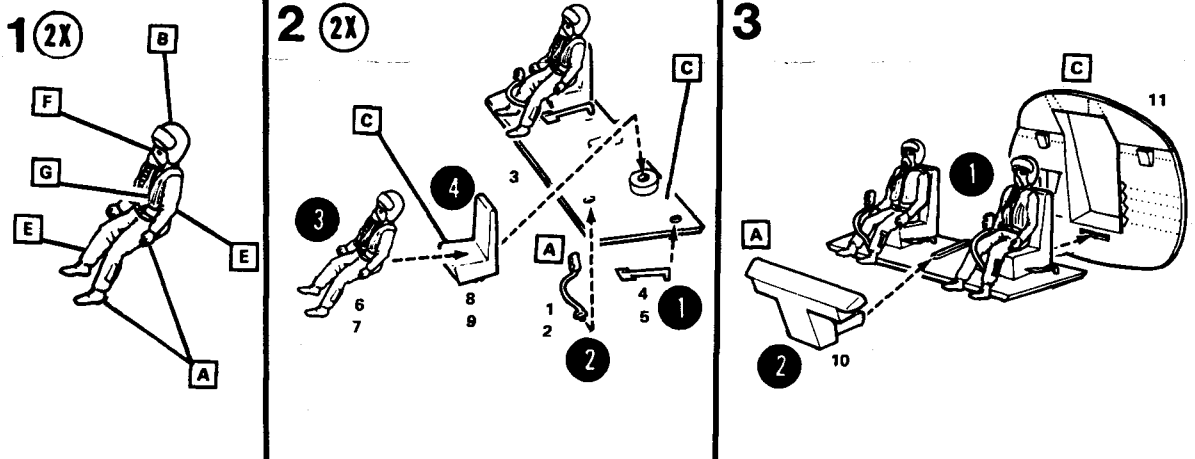

4

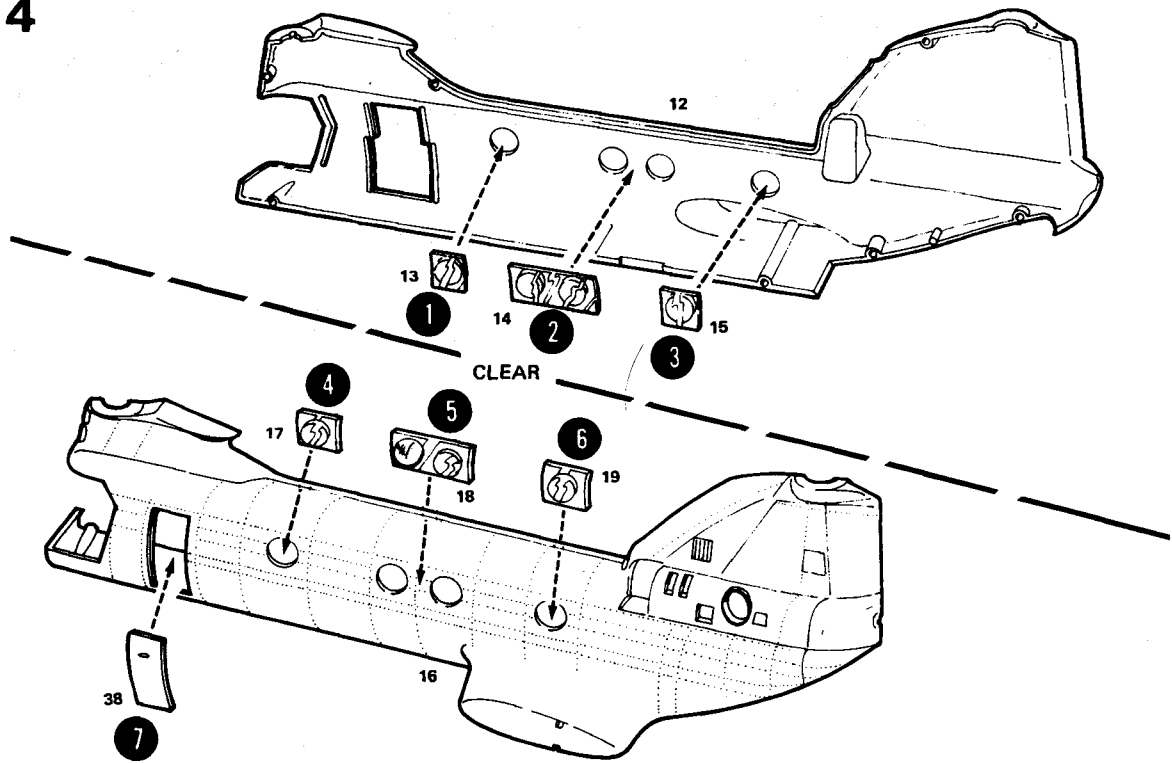

5 FRONT ROTOR ARMS

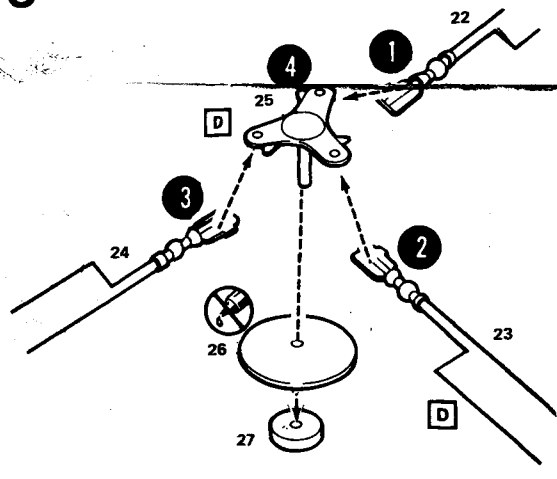

6 REAR ROTOR ARMS

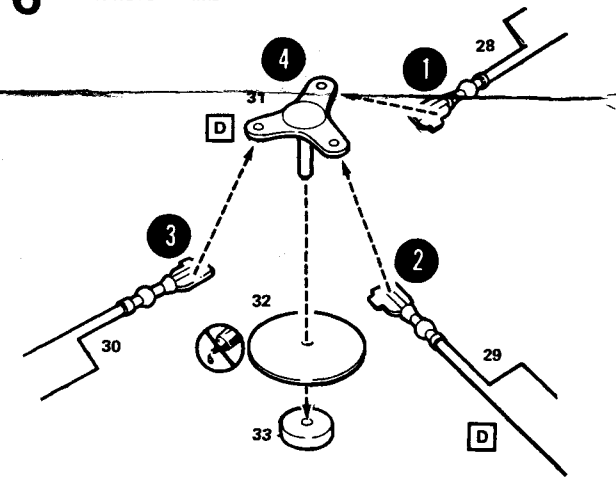

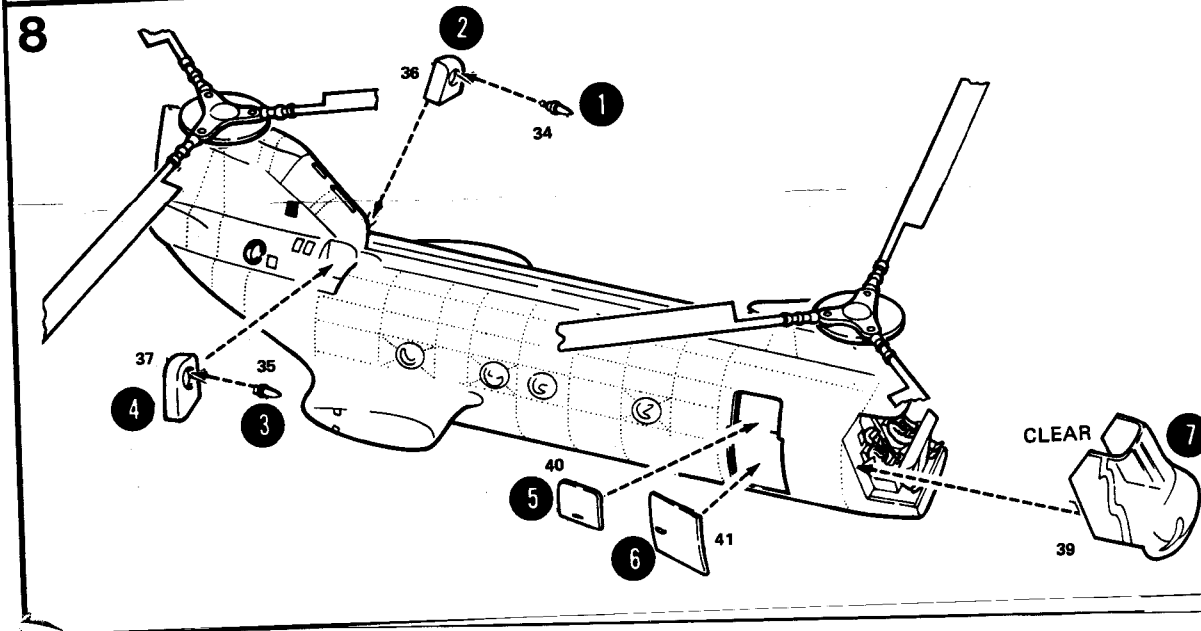
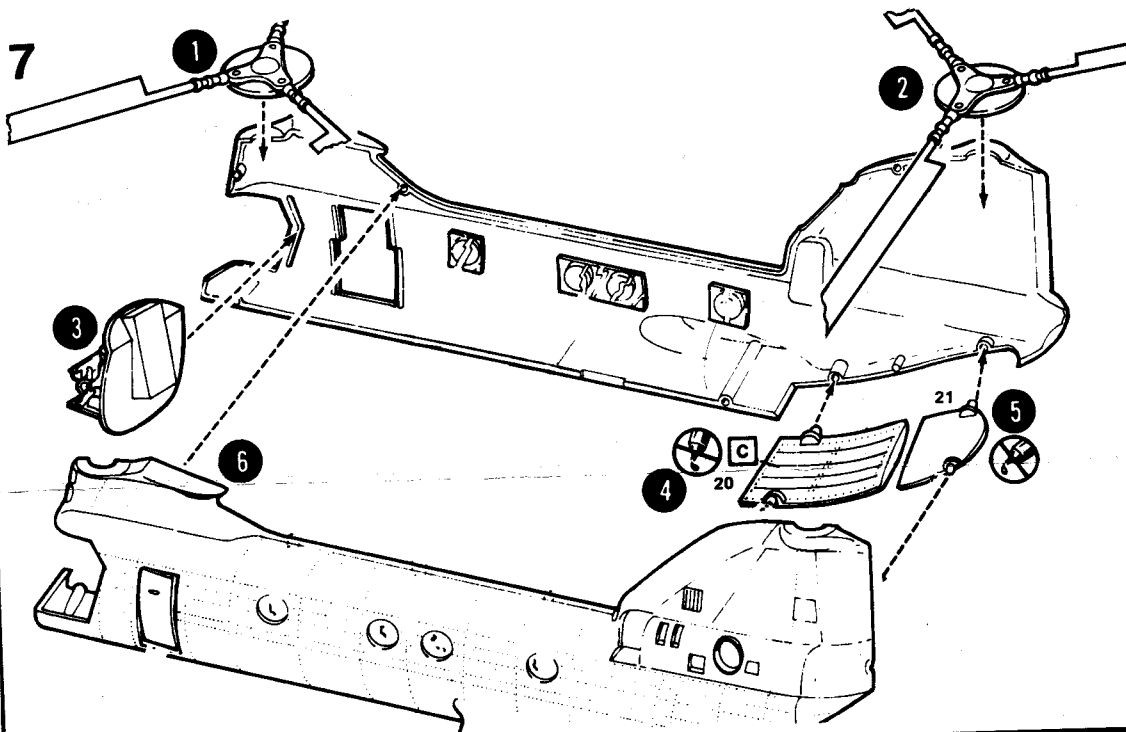

9

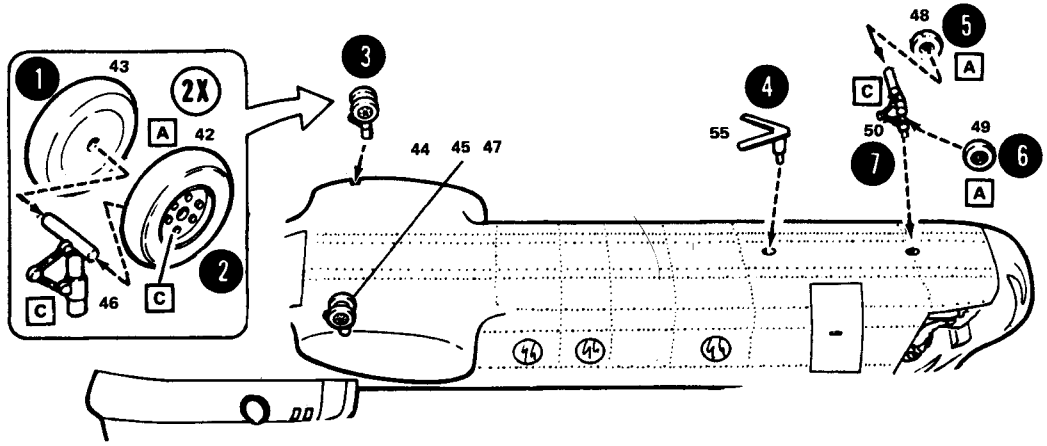

10

SEE BOX COVER FOR REFERENCE

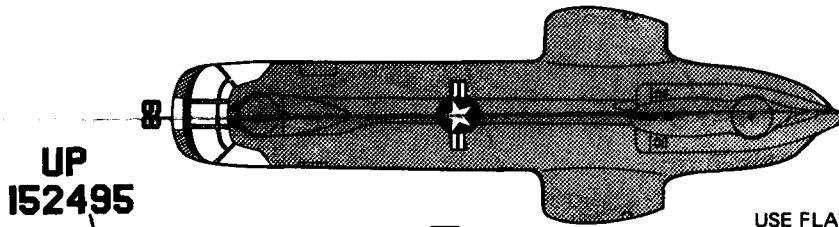
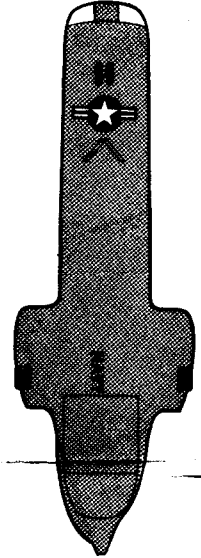

USE FLAT PAINT

A	BLACK
B	WHITE
C	LT. GREY
D	SLATE BLUE
E	O.D. GREEN
F	FLESH
G	YELLOW