

72054 Fokker F.VIIb/3m 1/72

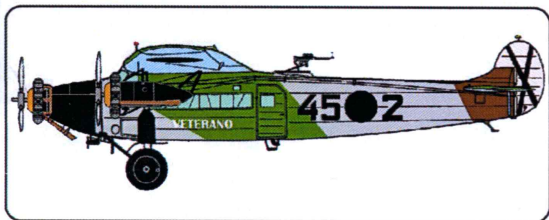

VALOM
Kloknerova 9, 148 00, Praha 4 - Chodov
Czech Republic



Stručná historie

Bezpochyby jeden z nejslavnějších letounů meziválečného období 20tých a 30tých let minulého století byl letoun holandské firmy Fokker - Fokker F.VII v různých verzích. První prototyp Fokker F.VII vzletl v r. 1924 ještě v jednomotorové koncepci s motorem Packard Liberty. V roce 1925 byl pro nedostatečné výkony doplněn o další dva motory v gondolách pod křídlem na každé straně. Motory byly tentokrát již Wright J-4 Whirlwind s výkonem 147 kW. Takto vylepšený letoun nesl označení F-VIIa/3m a kromě dvou nových motorů zůstaly základní parametry stejné. Bylo však zřejmé, že takto koncipovaný letoun by mohl nést daleko větší náklad dalšími zvýšením výkonu motorů a zvětšenou plochou křídla. Proto v r. 1928 bylo prodlouženo podstatně křídlo a letoun byl osazen motory Wright J-5 Whirlwind o výkonu 162 kW každý. Typ nesl označení F.VIIb/3m.

Fokker F.VIIb/3m se používal jak pro civilní tak vojenské účely. V civilní verzi mohly pojmout dvě dvoučlenné posádky až 8 cestujících. Pro své výkony a spolehlivost se stal velmi oblíbeným dopravním letounem své doby. To vedlo k rozšířením jeho výroby pod licencí Fokker do řady zemí např. Polska (Plage i Laskiewicz - 20 vojenských + 11 civilních), Anglie (Avro 618 Ten - 14 letounů, z toho 7 později odesláno do Austrálie), Československa (Avia - 13 civilních + 1 vojenský), Belgie (SABCA - 29 letounů), Itálie (IMAM Ro.10 - 4 letouny), Španělsko (Loring - 3 letouny) a 2 letouny byly sestaveny v Americe u Atlantic Aircraft Corporation. Celkem bylo vyrobeno 154 kusů těchto letounů z toho v domovském Holandsku jen 57 kusů.

Pro vojenské účely byly používány zejména v Polsku ve verzi bombardéru. Ve Španělsku byly nasazeny vojenské bombardovací verze se střeleckou věží na horní straně trupu na obou bojujících stranách konfliktu Španělské občanské války. Jeden letoun v bombardovací verzi byl i ve výzbroji československého letectva.

Využití Fokker F.VIIb/3m bylo velice široké jak z hlediska počtu uživatelů, jeho účelovosti, tak i konstrukční variantnosti (zejména motorů) a přesahuje rámec této stručné historie. V civilní dopravní verzi létaly v deseti státech světa, vojenskou verzi pak využívalo osm států.

Připomenout lze jejich účast na polárních expedicích např. Richard E. Byrd přelet severního pólu na F.VIIa/3m „Josephine Ford“ v květnu 1926, významných přeletů např. z USA na Havaj v červnu 1927 (Maitland a Hegenberger) nebo přelet Atlantiku první ženou Amelií Earhart na Fokkeru F.VIIb/3m „Friendship“ v červnu 1928 a nejnámější přelet Pacifiku z USA do Austrálie Sirem Charlesem K. Smithem na slavném „Southern Cross“ rovněž v červnu 1928.

Na Fokkerech F.VIIb/3m mohly být použity prakticky jakékoliv motory o dostatečném výkonu. Různými uživateli bylo používáno až 12 typů motorů. Nejvíce byl používán motor Wright Whirlwind, Armstrong Siddeley Lynx, Gnome-Rhone Titan., Škoda - Wright Whirlwind, Walter Castor a další.

Výroba Fokkerů F.VIIb/3m byla ukončena v roce 1932.

A brief history

Undoubtedly one of the most famous airplanes of inter-war area of the twenties and thirties of the past century was Fokker - Fokker F.VII from the Netherlands-based company in various versions. The first prototype of Fokker F.VII lifted off in 1924 as a single-engined concept with Packard Liberty engine. In 1925, for insufficient engine power, two more engines were added to the pods under wings on each side. This time the engines were Wright J-4 Whirlwind with 147 kW engine power. The improved airplane was designated as F-VIIa/3m and the basic parameters remained the same except for two new engines. However, it was obvious the airplane designed as such could have much higher loading capacity by further boosting of engines and enlarged wings area. Therefore, the wings were substantially prolonged and the airplane was fitted with Wright J-5 Whirlwind engines of 162 kW engine power each in 1928. The type was designated F.VIIb/3m.

Fokker F.VIIb/3m was used both for civil as well as army purposes. Up to eight passengers plus two crew members could be transported in the civil version. For its performance and reliability, the airplane was favourite passenger airplane of that time. This resulted in expansion of its production as Fokker licence in many countries, e.g.: Poland (Plage i Laskiewicz - 20 army + 11 civil), England (Avro 618 Ten - 14 planes, of which 7 delivered to Australia later), Czechoslovakia (Avia - 13 civil + 1 army), Belgium (SABCA - 29 airplanes), Italy (IMAM Ro.10 - 4 airplanes), Spain (Loring - 3 airplanes) and two airplanes were assembled in the USA in Atlantic Aircraft Corporation. In total, 154 airplanes were produced, of which 57 pieces only in the home Netherlands.

For military purposes, they were mainly used in Poland as a bomber. In Spain, military bomber versions with firing tower on the upper side of the fuselage were used by both conflict parties of the Spanish Civil War. One airplane in the bomber version was in the armament of the Czechoslovakian air forces.

Use of Fokker F.VIIb/3m was universal with respect to number of users, its purpose and structural versatility (especially of engines) and exceeds the borders of this brief history.

The civil and army versions were used in ten and eight countries of the world, respectively.

Their involvement in polar expeditions is worth of mentioning; e.g. Richard E. Byrd crossing of the North Pole with F.VIIa/3m „Josephine Ford“ in May 1926, important crossings e.g. from the USA to Hawaii in June 1927 (Maitland and Hegenberger) or crossing of the Atlantic Ocean by the first lady Amelia Earhart with Fokker F.VIIb/3m „Friendship“ in June 1928 and the most famous crossing of the Pacific Ocean from the USA to Australia by Sir Charles K. Smith with famous „Southern Cross“ in June 1928.

Almost any engine of sufficient engine power could be used with Fokker F.VIIb/3m.

Different users used up to 12 engine types. The following engines were used most often: Wright Whirlwind, Armstrong Siddeley Lynx, Gnome-Rhone Titan, Škoda - Wright Whirlwind, Walter Castor and others. Production of Fokker F.VIIb/3m was ended in 1932.

Technická data:

Rozpětí (m)	21,71
Délka (m)	14,48
Výška (m)	3,89
Max. rychlost (km/hod)	185
Dolet max. (km)	775
Dostup (m)	4880

Technical Data:

Wingspan (ft)	71,25
Length (ft)	47,50
Height (ft)	12,75
Max. speed (mph)	115
Range (mils)	480
Ceiling (ft)	16000

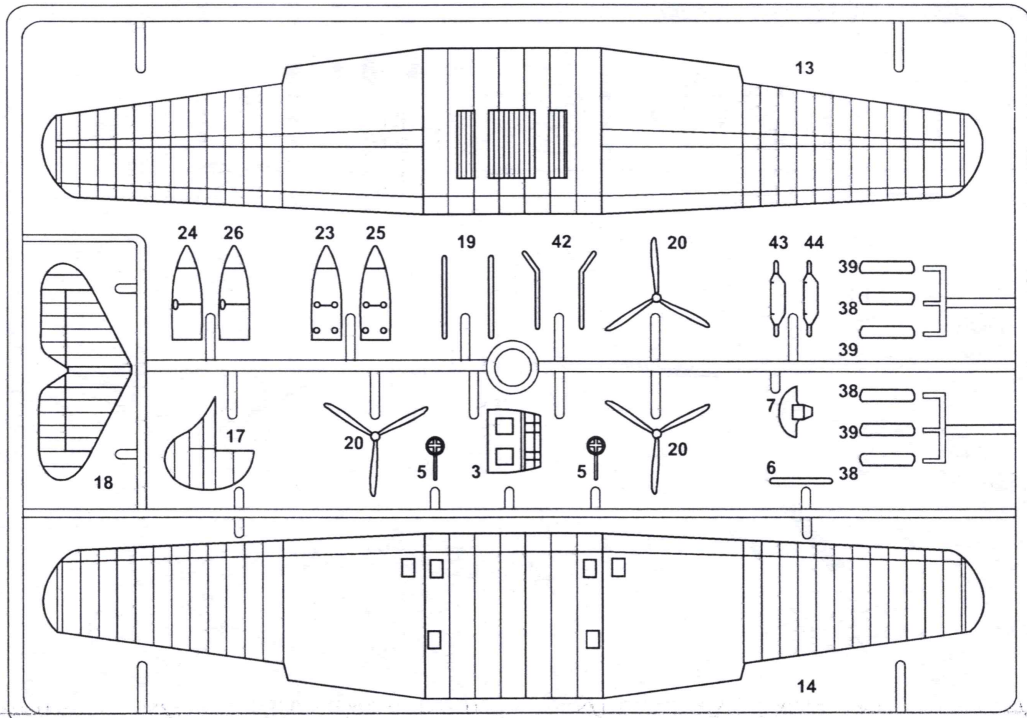
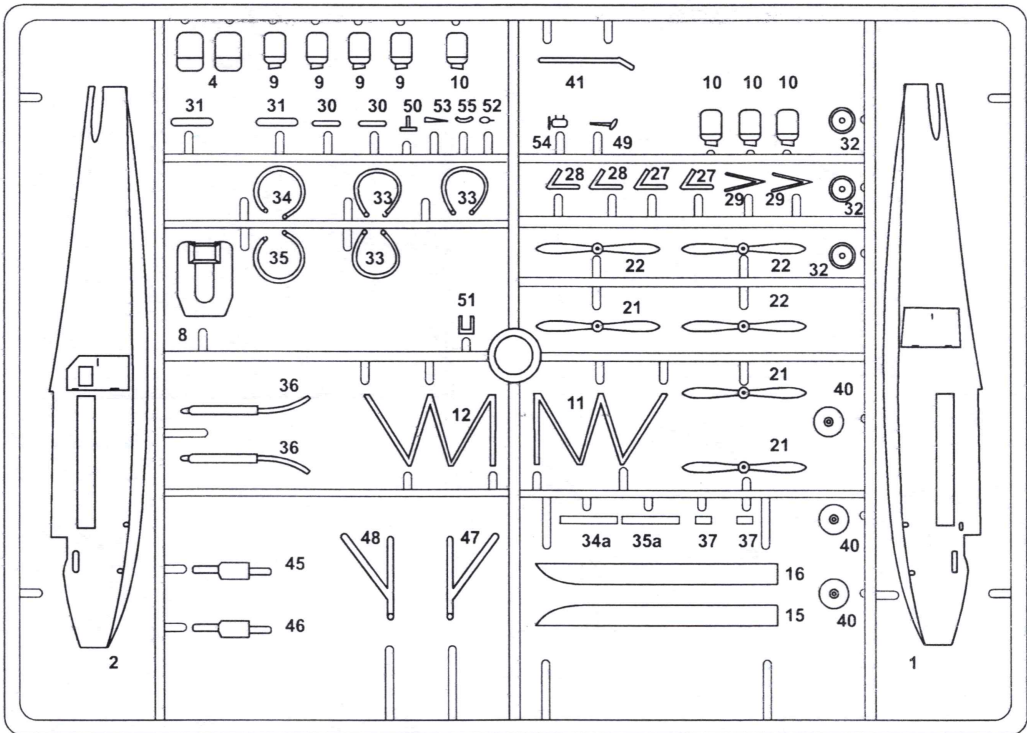

Clear Parts

Pruhledné díly

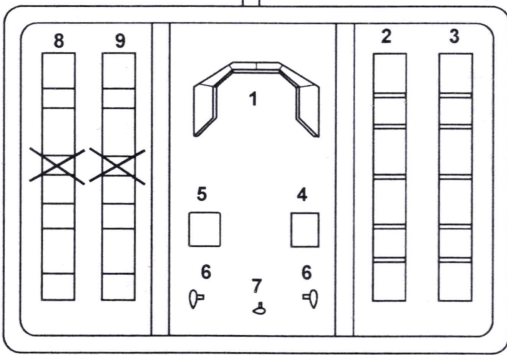

Metal Parts
Kovové díly

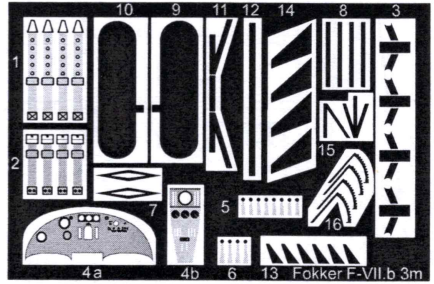

Resinové díly
Resin Parts

Decals

F1

F2

obtisky

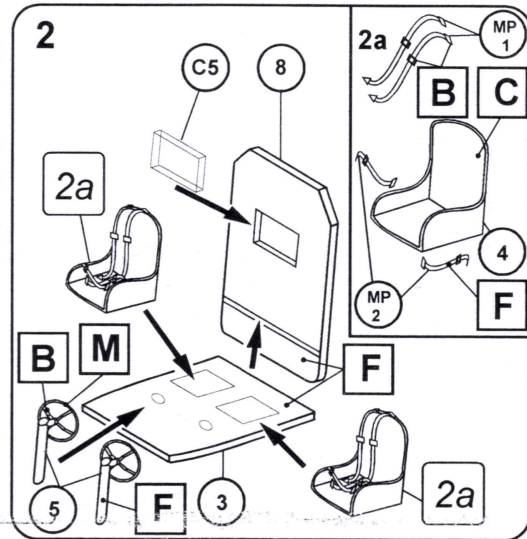
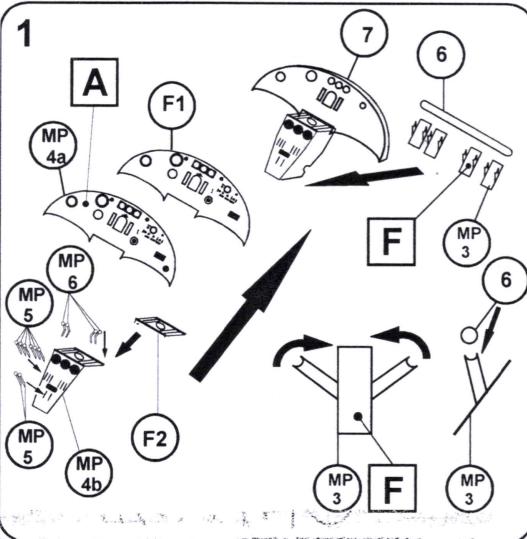
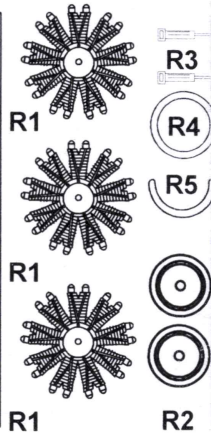
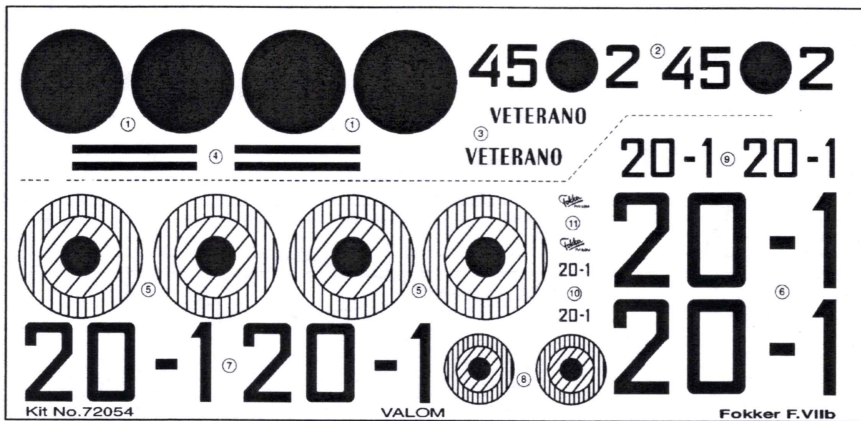

3

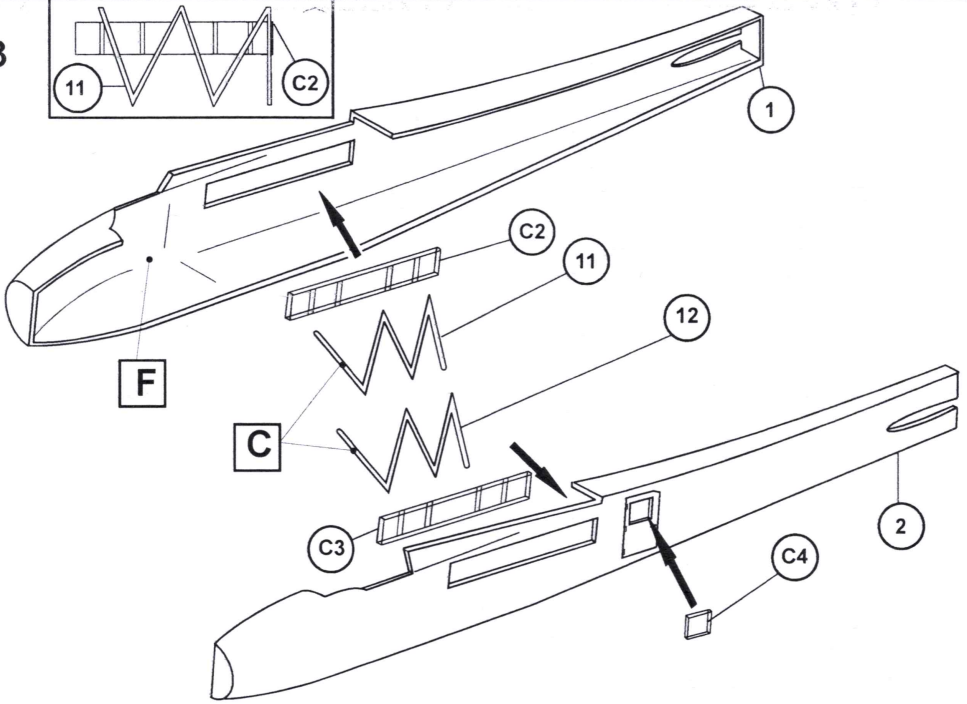
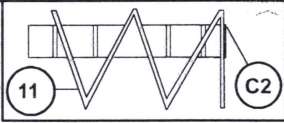

4

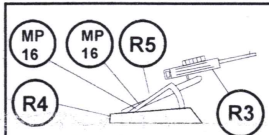
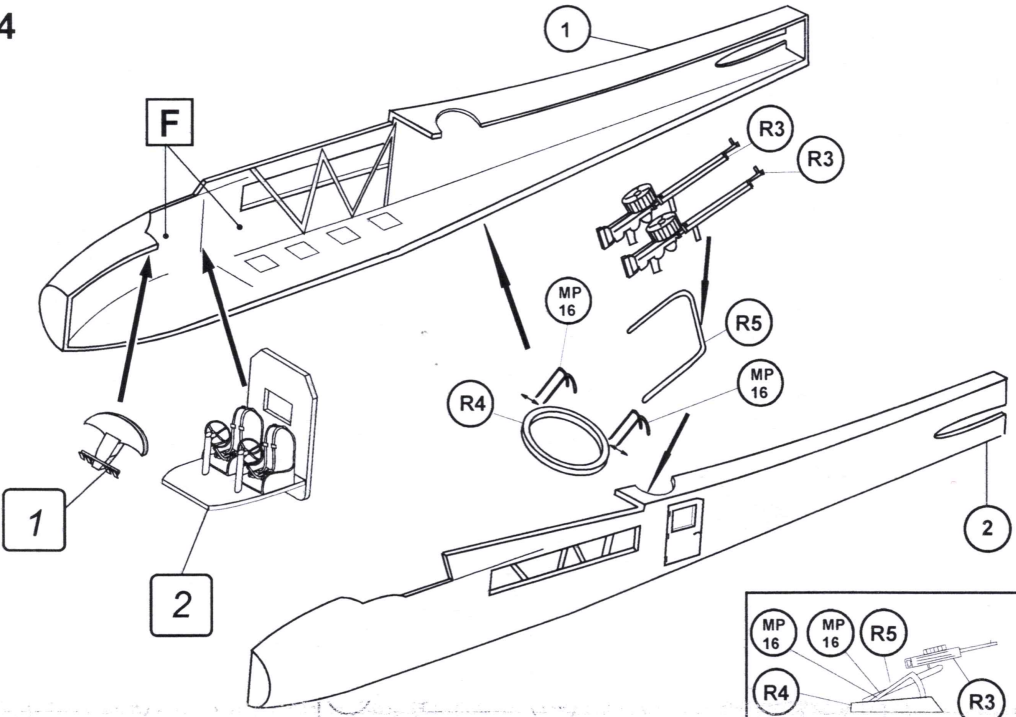

7

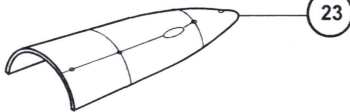

23

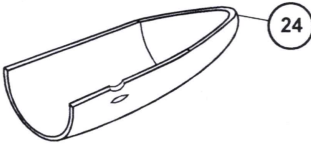

24

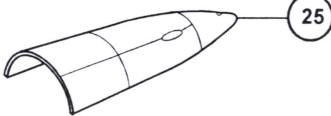

25

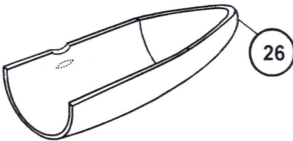

26

8

odříznout
cut

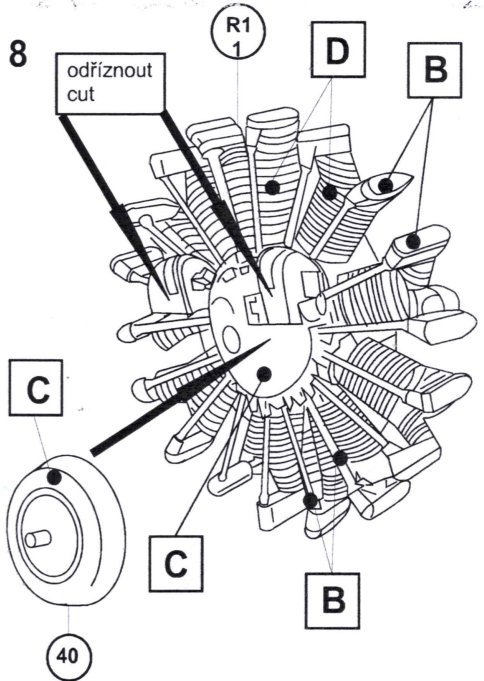

9

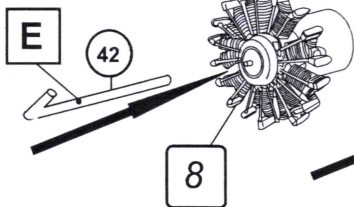

42

E

8

7

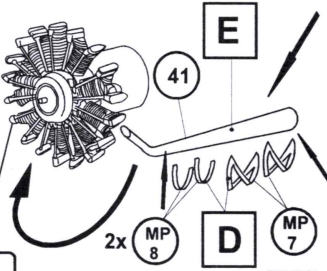
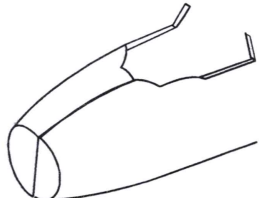
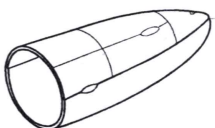

41

E

2x MP 8

D

MP 7

8

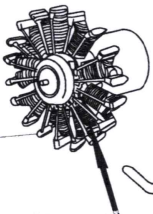

42

8

7

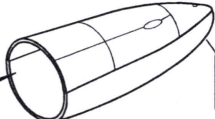

E

10

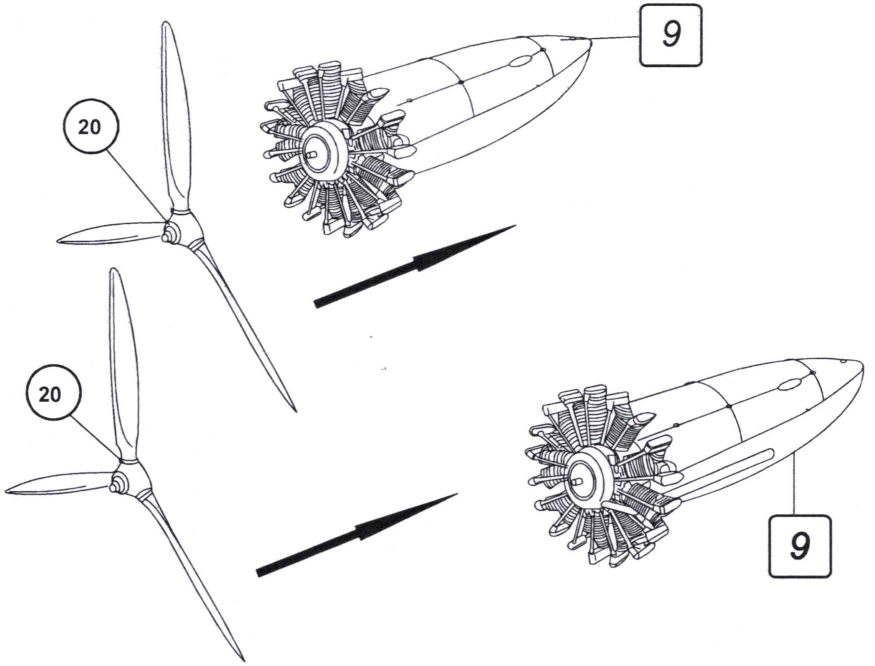

11

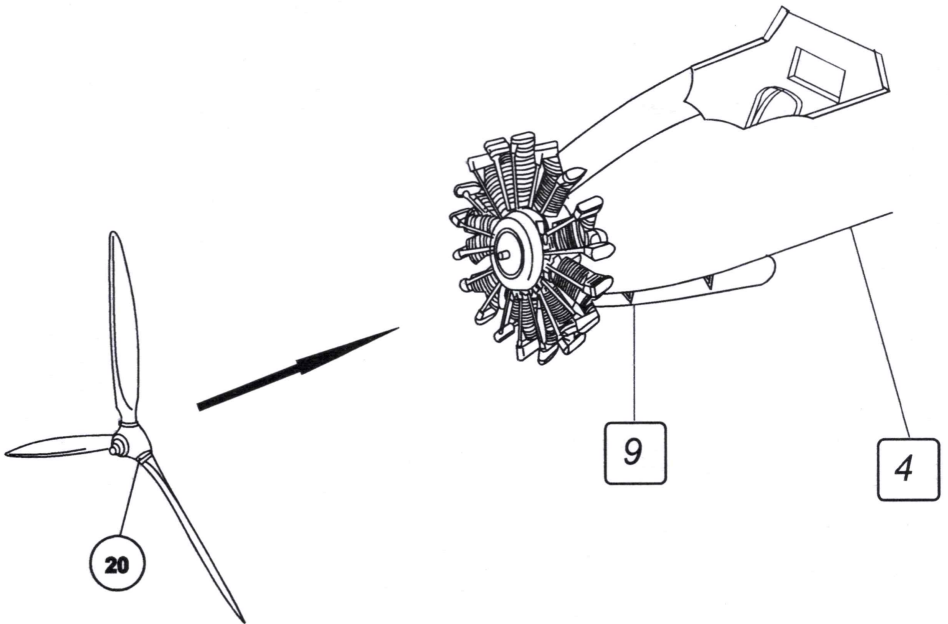

12

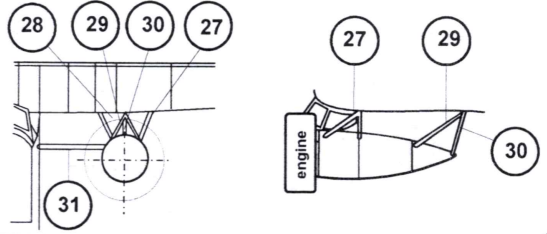
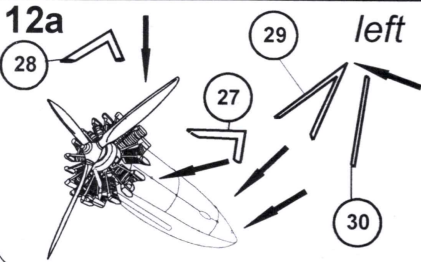
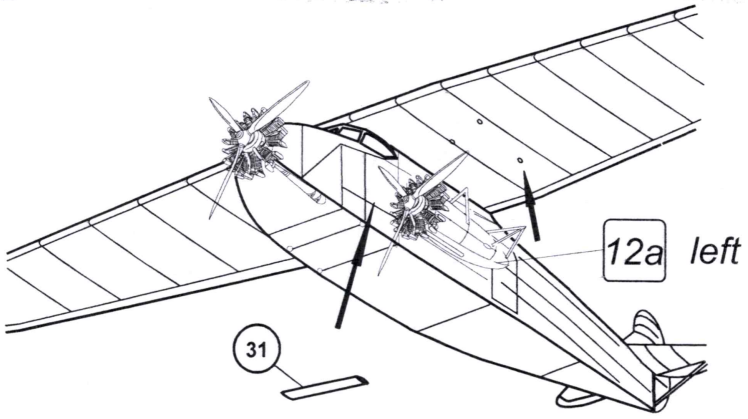

13

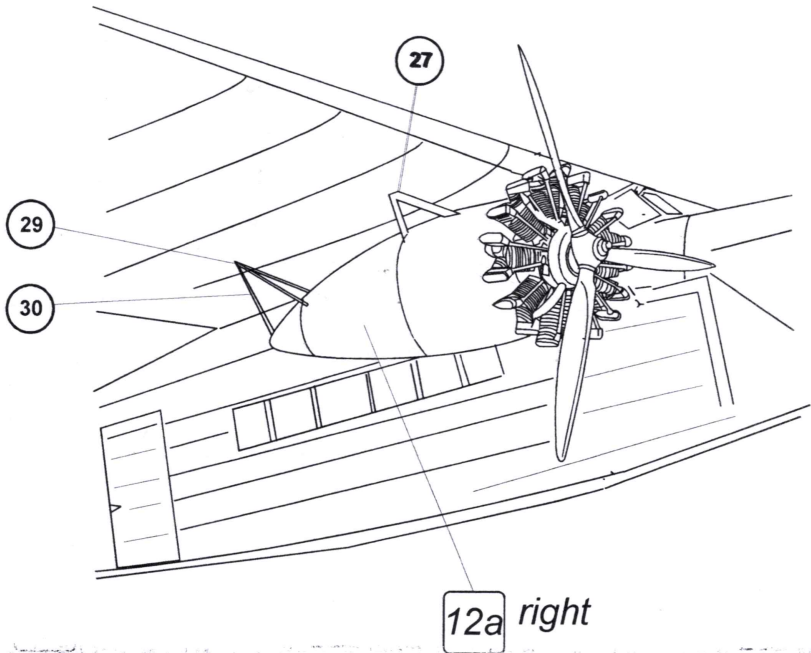

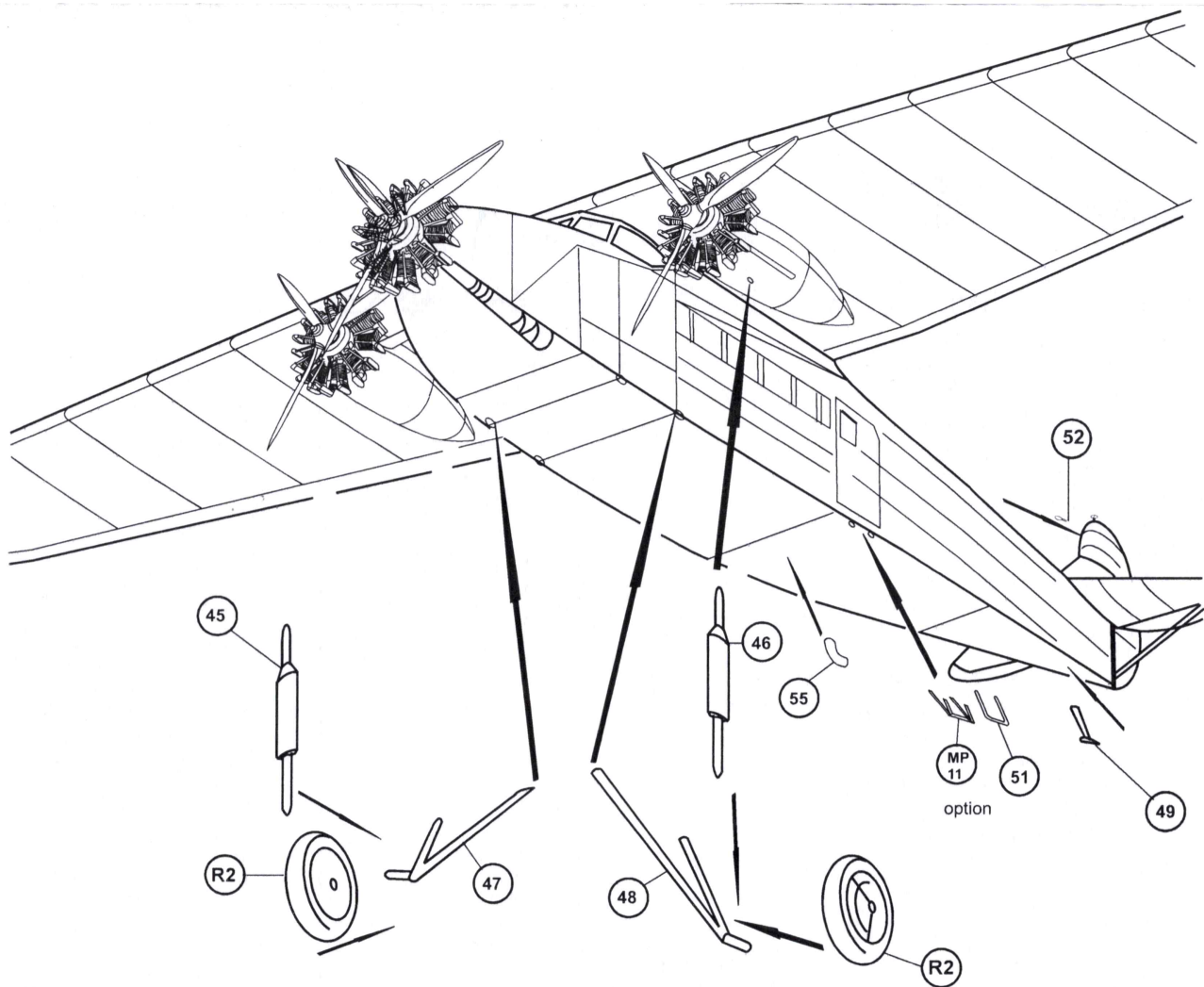

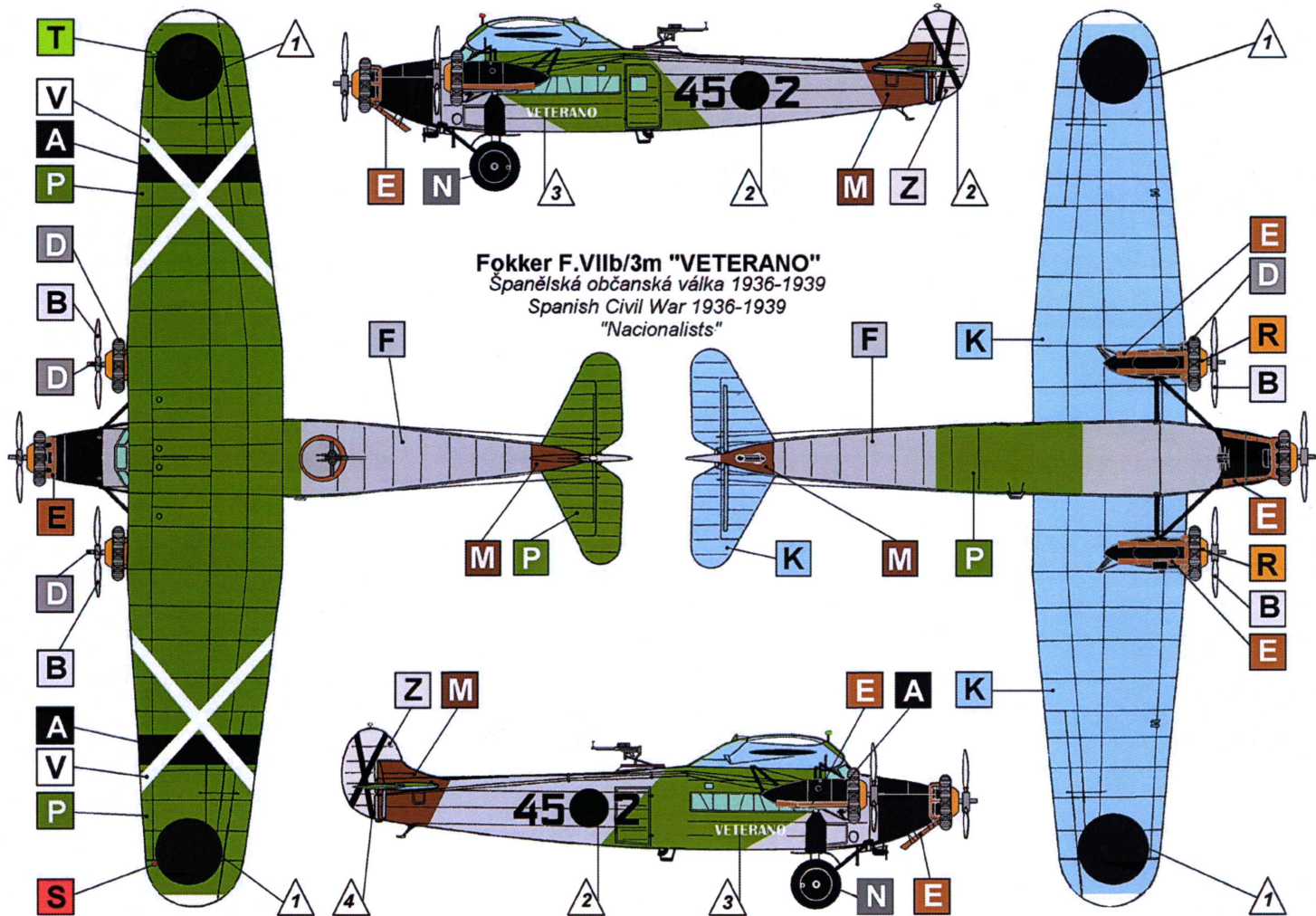

Fokker F.VIIb/3m "VETERANO"
 Spanělská občanská válka 1936-1939
 Spanish Civil War 1936-1939
 "Nationalists"

	Humbrol	Agama	Model Master	Gunze Sangyo	F. S. 595b
A černá Black	33	07	1749	H12	37038
B stříbrná Silver	11	08Me	1546	H8	---
C hliník Aluminium	56	46Me	1786	---	17178
D motorová šedá Engine Grey	128	A46	1725	H339	16081
E výfuky Exhaust Tubs	113	54	1406	H344	30111
F šedá Grey	32	R4	1730	H325	26440
G barva kůže Leather	62	12	1736	H66	30215
H modrá tmavá Dark Blue	25	09	1510	---	35180
J modrá světlá Medium Blue	47	A41	1508	H45	15200
K azurová modrá Azur Blue	157	B13	2048	H323	35450
L žlutá Yellow	18	A48	1595	H94	13655
M hnědá Brown	98	C61	1540	H47	20045
N barva pneumatik Tyre	182	36	1592	H77	37200
O khaki Khaki	72	A51	---	H81	34087
P zelená Green	2	19	1524	H26	14110
R mosaz Brass	54	45Me	1782	---	17043
S signální červená Signal Red	174	17	1705	H90	14227
T signální zelená Signal Green	208	19	1524	H94	14227
U signální žlutá Signal Yellow	154	15	1708	H91	13591
V bílá White	34	A21	1768	H11	37575
Z slonovina Ivory	41	39	2709	H21	17778



obtisk
Decal

Fokker F.VIIb/3m

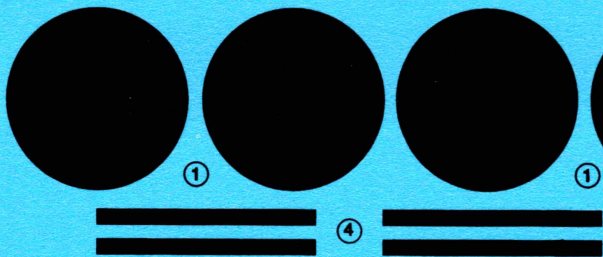

45 ● 2
45 ● 2

20-1 20-1

7

9



20-1

11

10



20-1

20-1 20-1

9

Kit No.72054

VALOM

3

VETERANO VETERANO

6

20-1
20-1

Fokker F.VIIb

CORRECTION

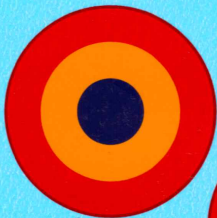

5



8

