

USS LEXINGTON CV-16

1:700 Scale

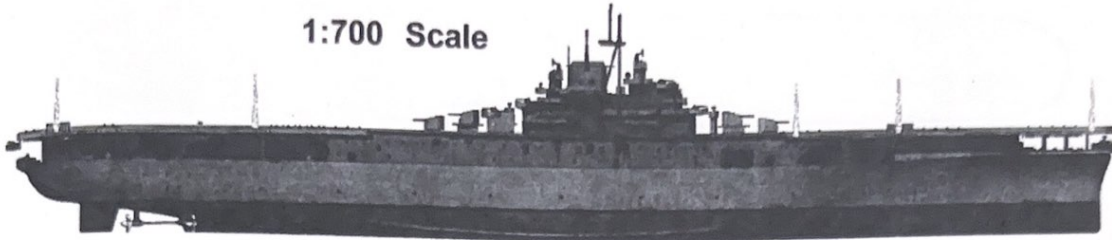

READ BEFORE ASSEMBLY

- Study and understand these instructions thoroughly before beginning assembly. Make sure all parts are included by comparing them to those shown on pages 2 & 3 of these instructions.
- Remove parts from sprues as needed, and trim excess with a hobby knife. Be careful not to lose small parts.
- Remove photo-etch parts from sprue as needed using a hobby knife or photo etch cutter.
- Apply cement to photo etch parts as shown on instructions.
- Applying too much cement will restrict the operation of these movable parts.
- Apply cement carefully! Removed photo etch parts can have sharp edges. Take care when handling these to avoid injury.
- Apply decals to necessary parts prior to assembly.
- Additional tools recommended(not included):Sprue cutter, Long nose pliers, hobby knife, file, tweezers, pin vise, scissors, cement, sandpaper, soft cloth, glue and paint.
- Keep all parts out of reach of children, as they pose a choking hazard. Discard all unnecessary bags and sprues when model is completed to avoid accidental injury.



file / sand



option



no cement



decal



cyanoacrylate glue



weight



make hole



cut / remove



bend

DECAL APPLICATION

1. Cut off decal from sheet.
2. Dip the decal in tepid water 40°C for about 10 sec. and place on a clean cloth.

3. Hold the backing sheet edge and slide decal onto the model.
4. Move decal into position by wetting decal with finger.
5. Press decal gently down with a soft cloth until excess water and air bubbles are gone.



Parts

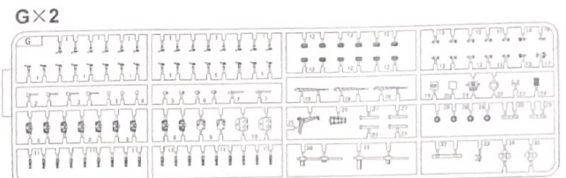
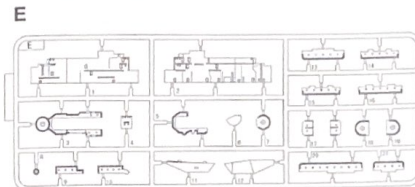
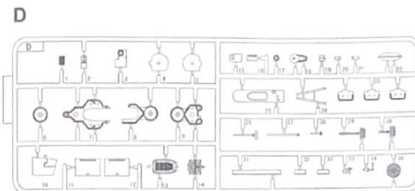
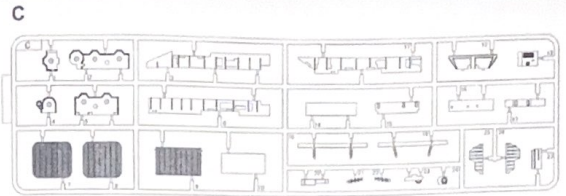
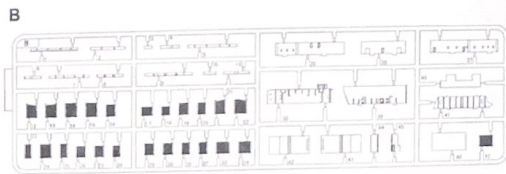
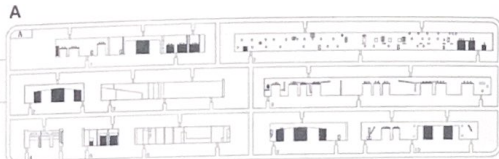
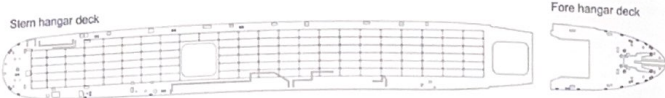
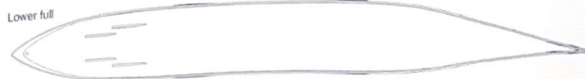
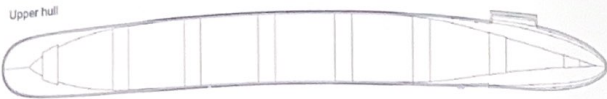

TBF x 4 sprue

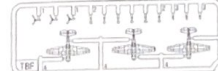

F6F x 4 sprue

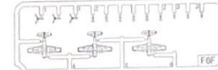

Decal

SB2C x 4 sprue

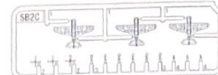

SBD x 4 sprue

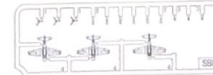

4 Assembly of hangar deck

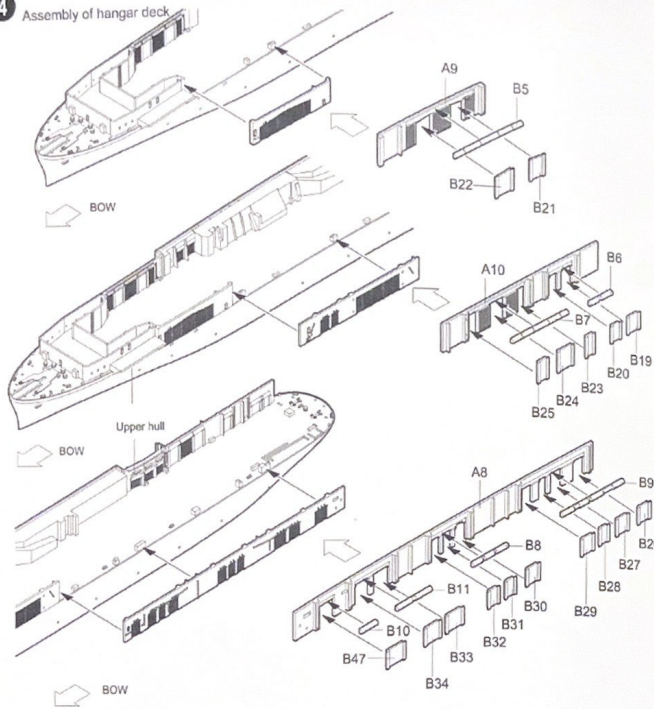

5 Assembly of stern

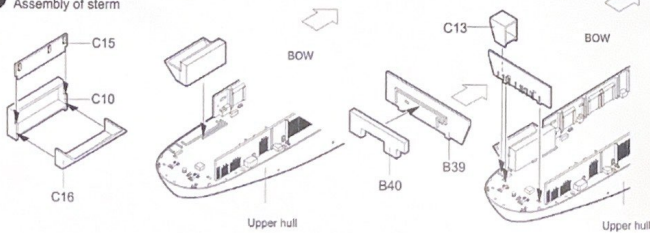

6

6 Assembly of stern

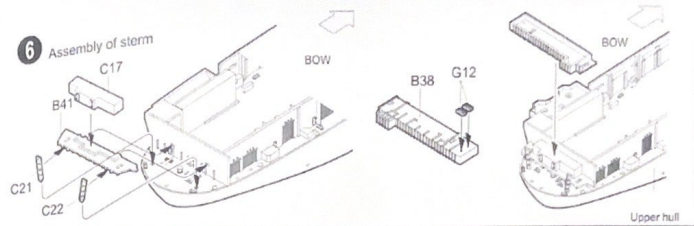

7 Assembly of parts

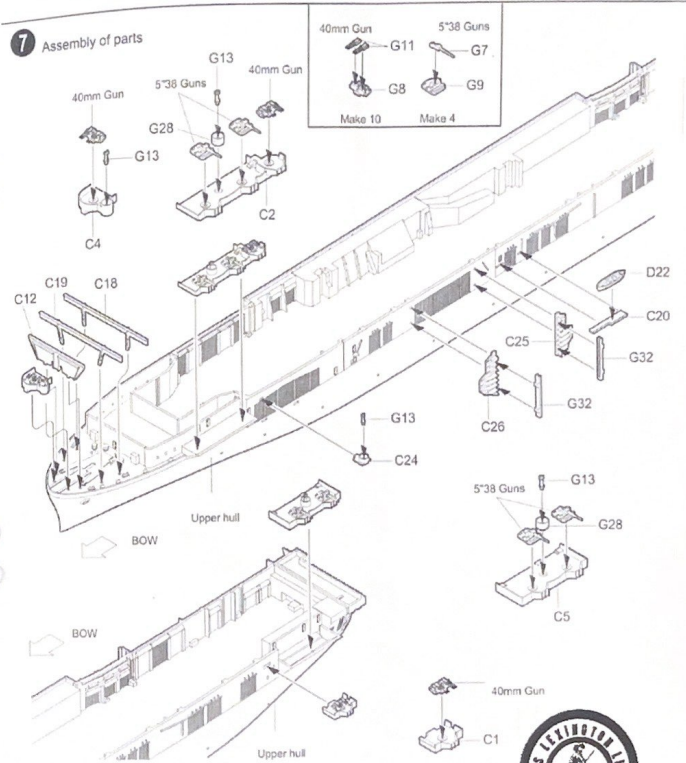

7

8 Assembly of parts

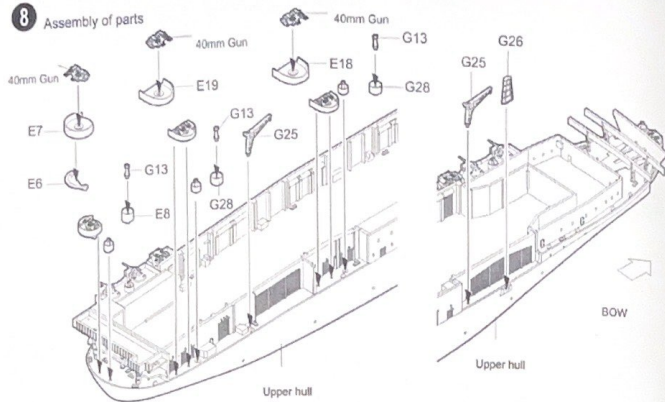

9 Assembly of deck

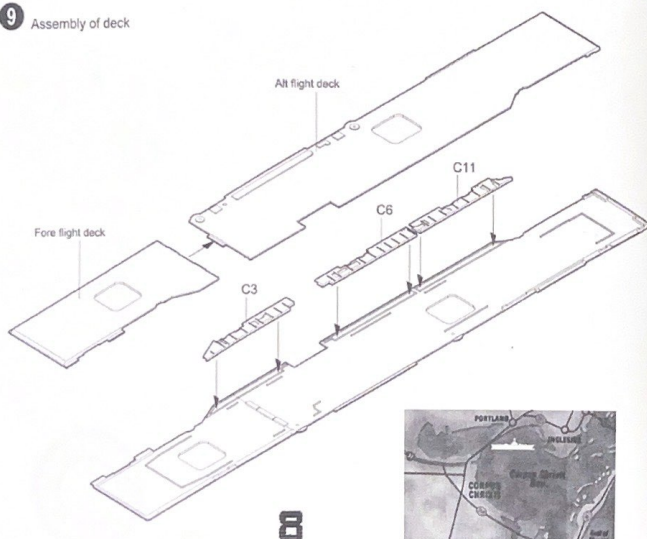

10 Assembly of flight deck

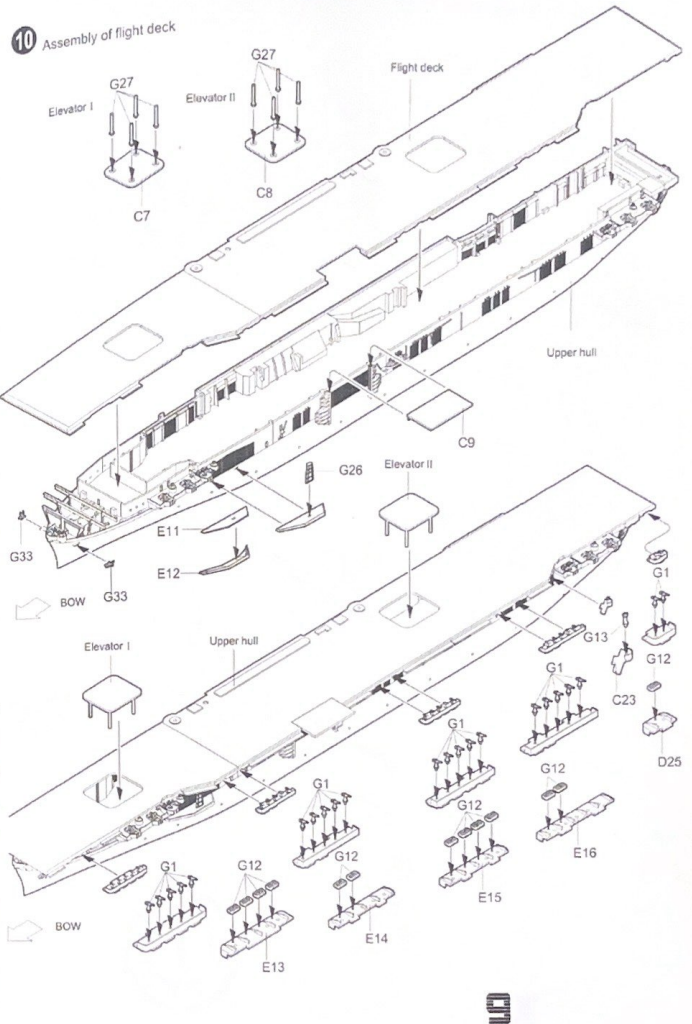

11 Assembly on the flight decks

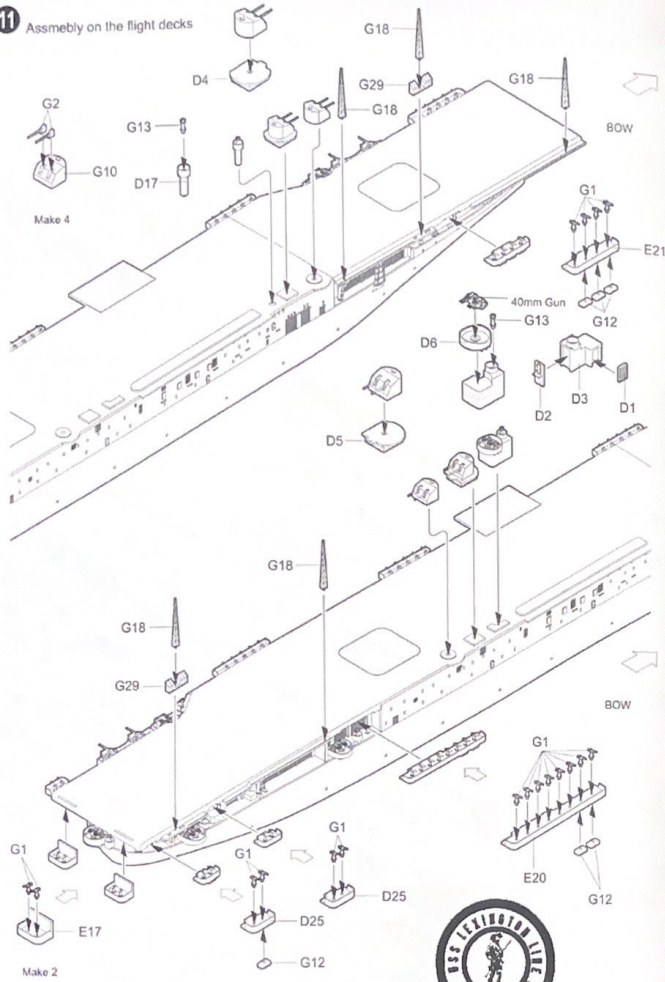

12 Assembly of Island

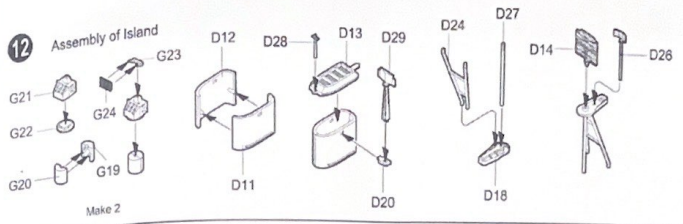

13 Assembly of Island

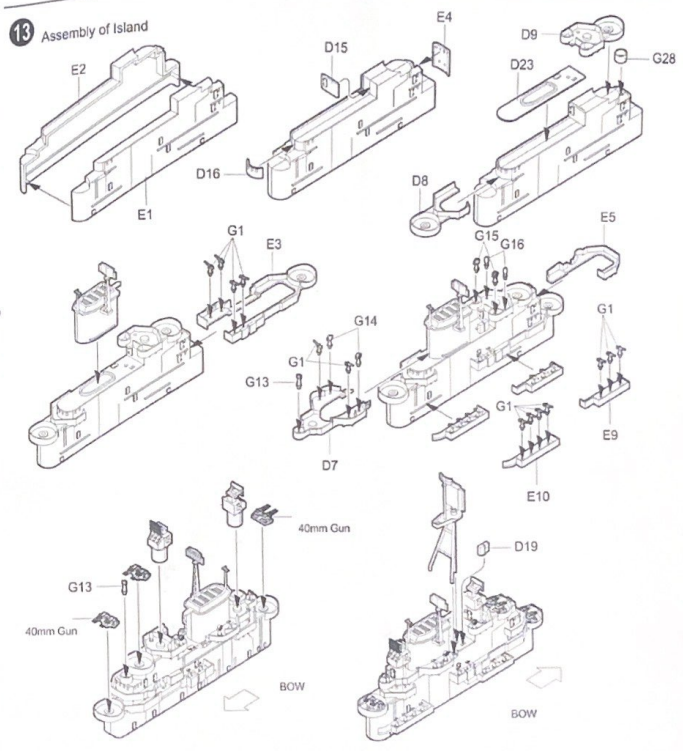

14

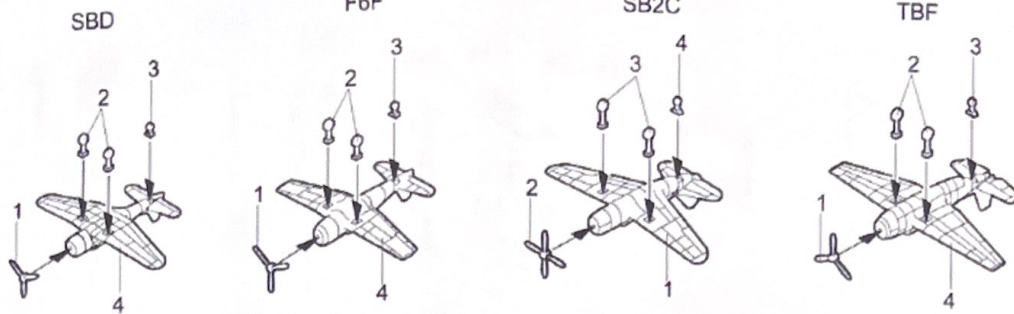

15

If you are going to build the full hull version then do not glue the waterline plate to the upper hull.

