

DECALING - PAINTING

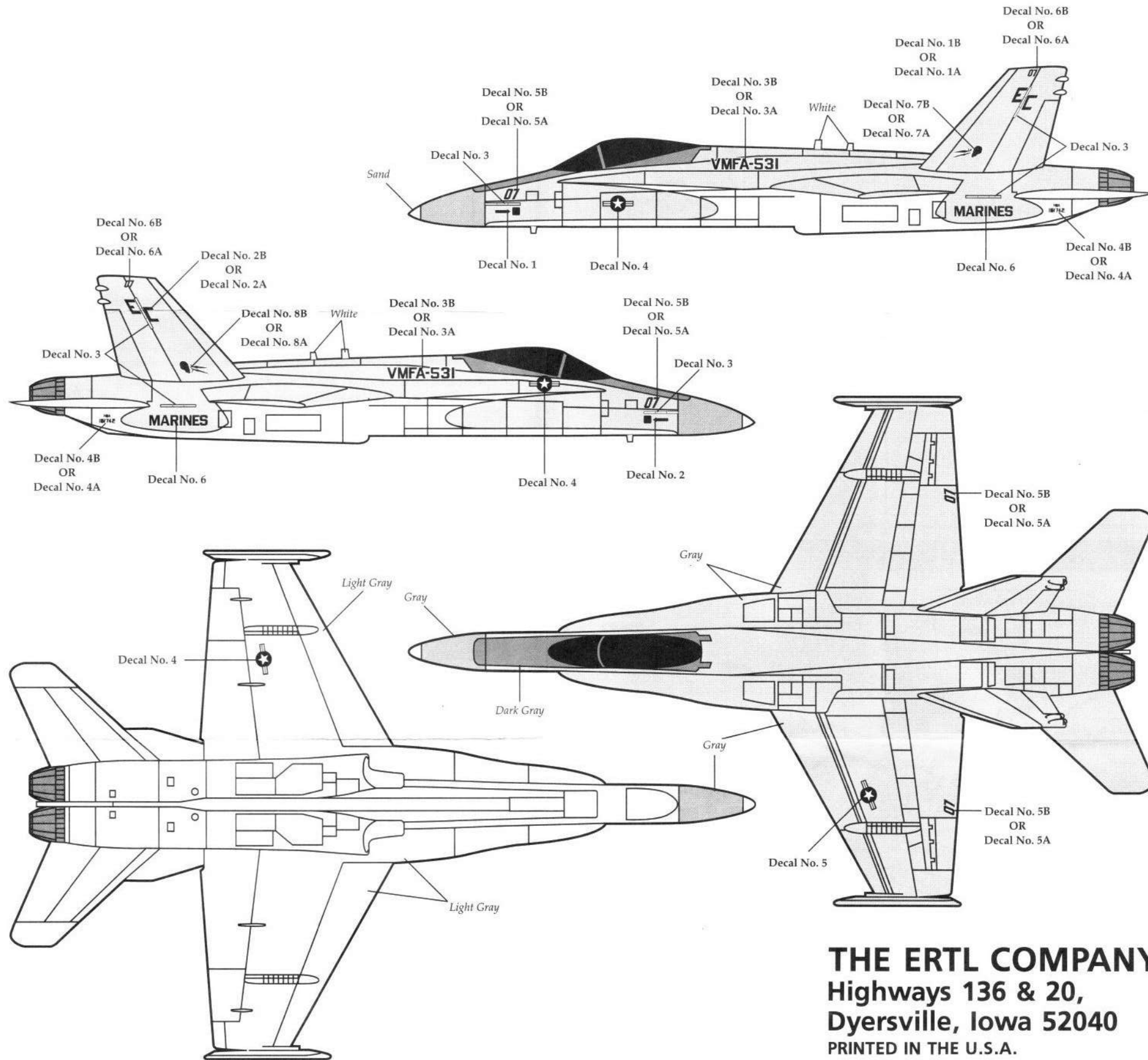

THE ERTL COMPANY
 Highways 136 & 20,
 Dyersville, Iowa 52040
 PRINTED IN THE U.S.A.

FORCE ONE

1 / 144 Scale
 Model Kit



Stock No. 8839
 Form No. 099 - 8839



**McDONNELL
 DOUGLAS**

F-18 HORNET

In the early '70s, the U. S. Air Force identified the need for a light-weight fighter aircraft that would be supersonic, agile and less costly to build than the existing large, complex and rather expensive aircraft in use. Consequently, bids went out in '71 to several U. S. aircraft manufacturers. Paring their design proposals down to two firms, General Dynamics and Northrop were both awarded contracts to build prototypes of their respective aircraft. Selection was to be decided between the competing planes.

Drawing on their in-house development of an advanced fighter code-named the P-530 Cobra, Northrop took the Air Force specs for the new plane and applying these ground-rules to the Cobra project, re-named it the YF-17. General Dynamics rolled out a fresh concept in the YF-16, a single-engined Advanced Concept fighter. After a very close competition and 400 hours of exhaustive flight testing, the Air Force chose the YF - 16 as their new small fighter.

Although understandably disappointed, Northrop still had great faith in their new airplane and so too did the U. S. Navy, who had taken an active interest in the fly-off of these two remarkable aircraft. The twin engine design was the main feature of interest to the Navy as well as the smaller size, and as it happened, they had an independent research program going on called VFAX to replace the aging F-4 Phantom and A-7 Corsair. The basic design of both the YF-16 and YF-17 struck the U.S. Congress as being applicable to the Navy program, and with a little coaxing the planes were given serious consideration. The F-17 seemed better suited to aircraft carrier duty and was given the nod. As Northrop had not done many Navy planes and McDonnell - Douglas had, they formed a partnership and re-designed the YF-17. So extensive were the alterations required that the plane was re-named the F-18 Hornet and has proved to be a very good plane, successfully replacing the venerable F-4 Phantom and augmenting the A-7 Corsair.

IMPORTANT

Before you begin to assemble your model kit, study the instructions carefully. This will help you to familiarize yourself with the part locations as you proceed. Prior to cementing parts together, be sure to "TEST FIT" them in order to assure proper alignment and also to check for excess "FLASH" that may occur along parting lines. Use a sharp hobby knife or file to remove flash if necessary.

If you wish to paint your model, various sub-assemblies and components should be painted before any parts are attached. During assembly, you may note that the recommended color is stated after the part name.

This model kit is molded from the finest high-impact styrene plastic. Use only paints and cements which are specifically formulated for styrene. Read all labels and warnings carefully.

Because the cement will only adhere to bare plastic, it is necessary to remove any paint or "plating" from the area to which the cement is to be applied.

HOBBY KNIFE

Use a sharp hobby knife to remove parts from the trees. Some parts may appear to have an extra "tab" on them, these should be removed.

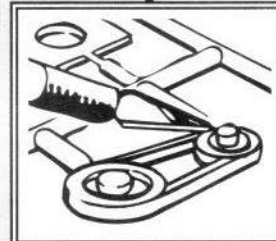

TWEEZERS

Tweezers are handy for holding very small parts during assembly or painting.

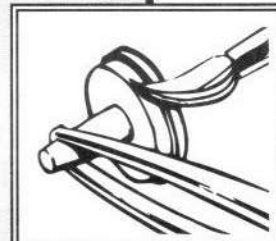

CEMENT

We recommend the use of liquid polystyrene cement. Apply with a fine brush or toothpick. Use cement sparingly or a sloppy job will result.

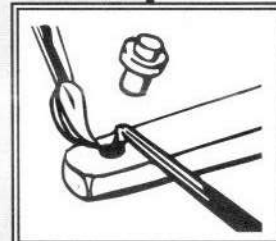

We take great pride in providing the finest model kits available, giving strong attention to detail and craftsmanship. Should you have any difficulty with assembly or missing parts, please call the appropriate number listed below between the hours of 8:00 am to 4:30 pm central time, Monday through Friday.

In IOWA (toll free) 1-800-942-4618
 Elsewhere in the U.S.A. (toll free) 1-800-553-4886
 Outside of the United States call 1-319-875-2000

1

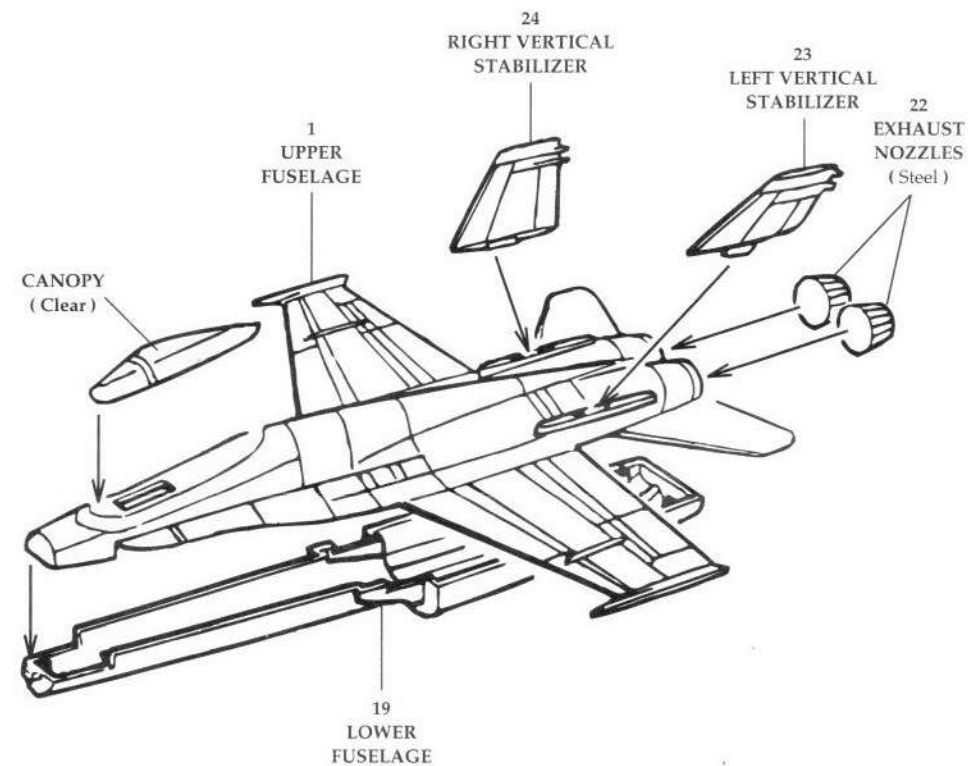

2

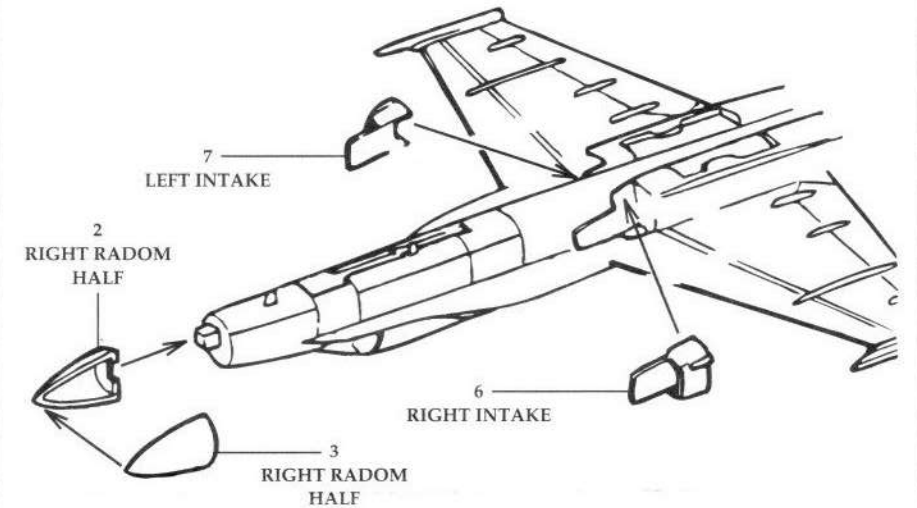

NOTE: For GEAR DOWN display [ASSEMBLY 3]
 Carefully cut Parts 10, 12 and 14 in half as shown.

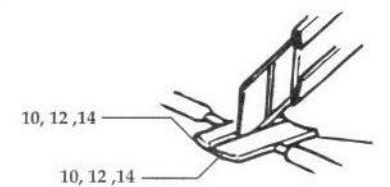

3

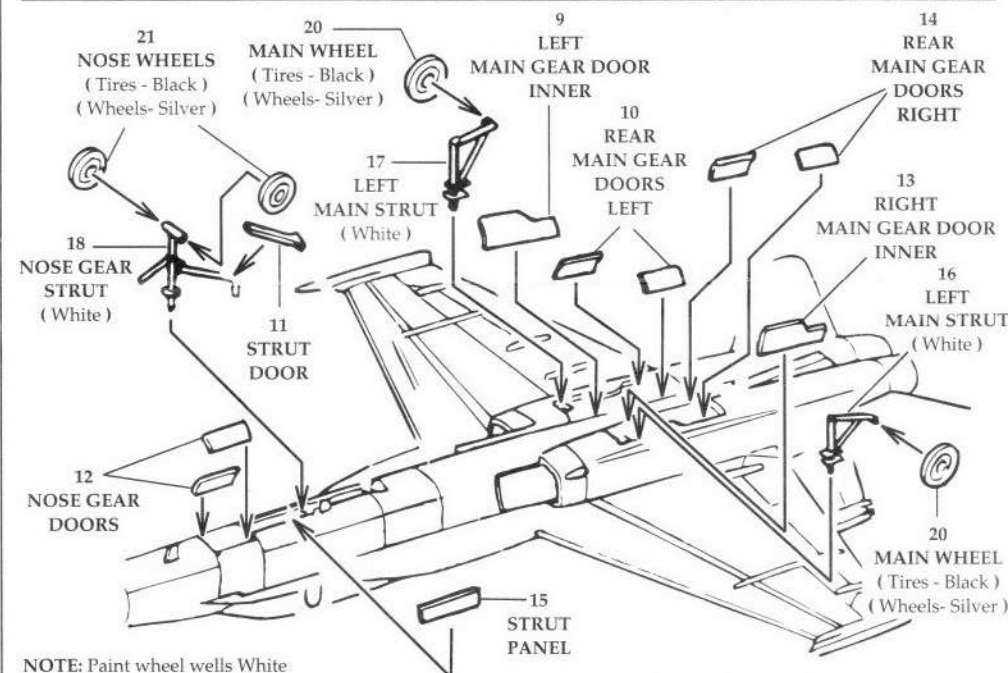

NOTE: Paint wheel wells White

NOTE: Correct position of Landing Gear Doors.



4

