

## Westland Sea King In Worldwide Service

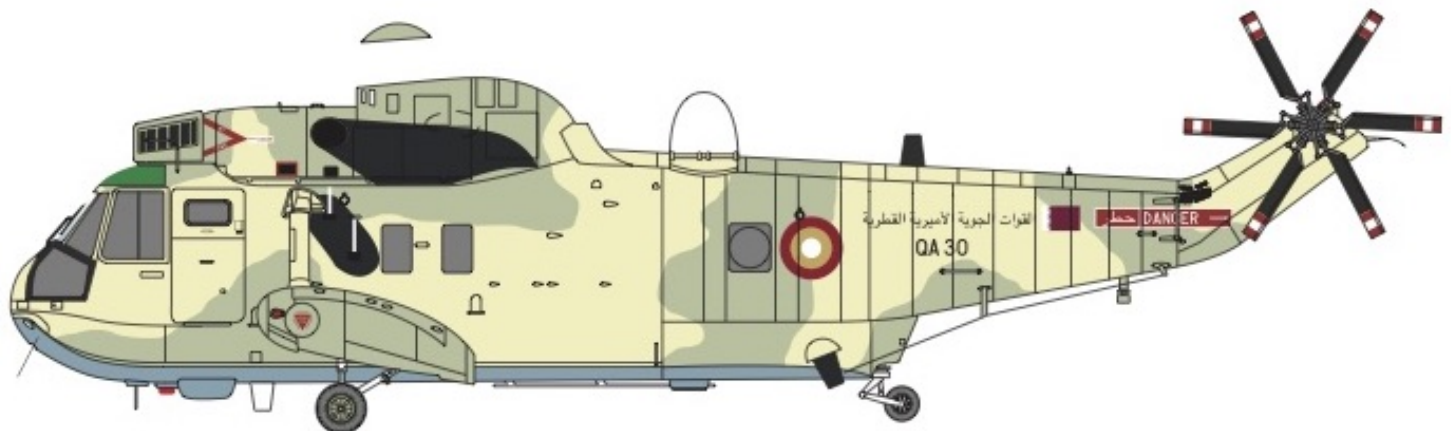

For the best results these decals should be applied to a gloss surface such as provided by either Xtracolor or Xtracrylix paints. Cut out the decal required and soak in warm water until the decal is released from the backing paper. Wet the area to be decaled with MICRO SET which will help to eliminate air trapped under the decal and position the decal.

After 5 or 10 minutes wet the decal with MICRO SOL which will soften the decal and ensure that it settles down over any surface detail. Allow the decal to dry for at least 12 hours. During this time some wrinkling of the decal may occur, this is normal. Do not touch the decal at this time.

Carefully check for small air bubbles and if there are any prick with a needle and apply a drop of MICRO SOL. After all air bubbles have been eliminated and the decals are dry wash the entire model with water to remove any excess decal adhesive.

When completely dry the whole model should be sprayed with a coat of Xtracolor or Xtracrylix Flat, Satin or Gloss varnish depending on the finish required.

Store in a cool dry place, avoid sunlight, dampness or extremes of temperature and/or humidity.

Westland Sea King Mk.43B,  
 '073',  
 of 330 Squadron,  
 Royal Norwegian Air Force,  
 Based at Bodø Main  
 Air Station,  
 Norway,  
 2014.

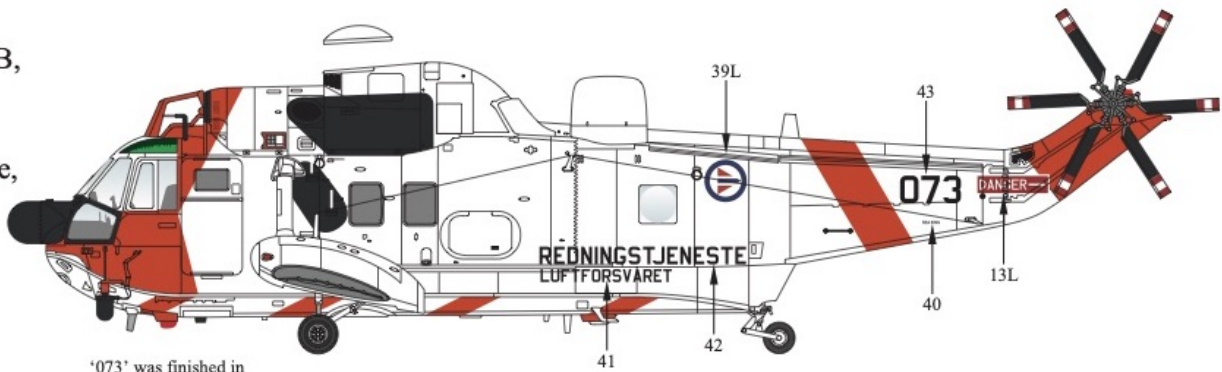

'073' was finished in overall Gloss White with Day Glo Orange areas. Matt BS381C:642 Black exhaust and cockpit glazing areas.

**Modellers Note:**  
 Six bladed tail rotor fitted.  
 Nose radome will need to be sourced aftermarket.



Westland Sea King Mk.50A  
 'N16-118'/'07'  
 of 817 Squadron,  
 Royal Australian Navy,  
 2005.

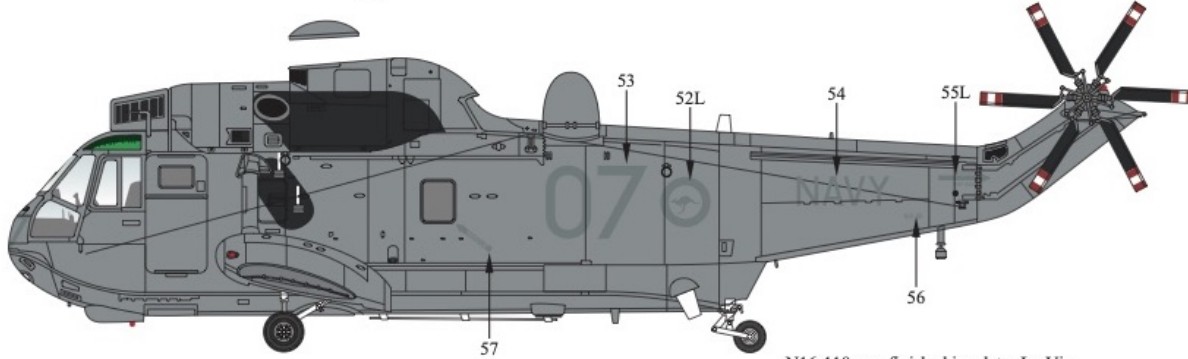

N16-118 was finished in a later Lo Viz scheme of overall Satin FS26320 Dark Compass Grey. Matt BS381C:642 Black radome, exhaust and cockpit glazing areas.

**Modellers Note:**  
 Six bladed tail rotor fitted.

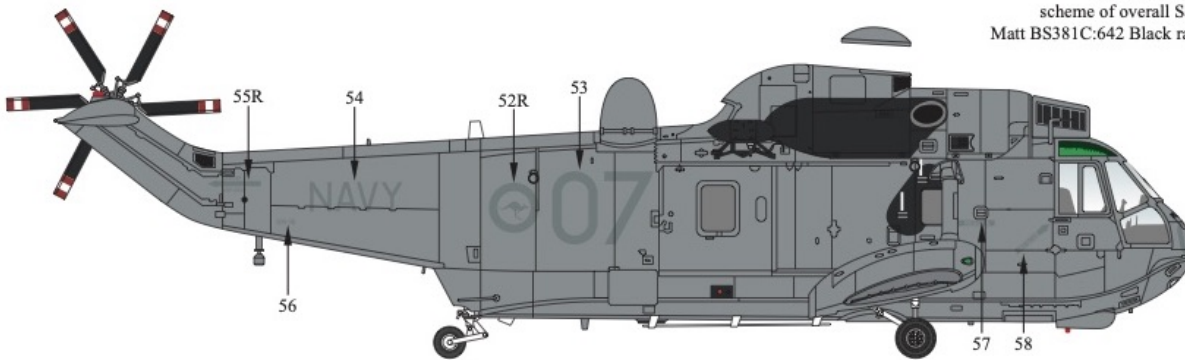

Westland Sea King Mk.45  
 '11'  
 Pakistan Navy,  
 2005.

'11' was finished in overall Gloss BS381C:633 RAF Blue Grey with Matt BS381C:642 Black exhaust areas. Gloss White radome cap.

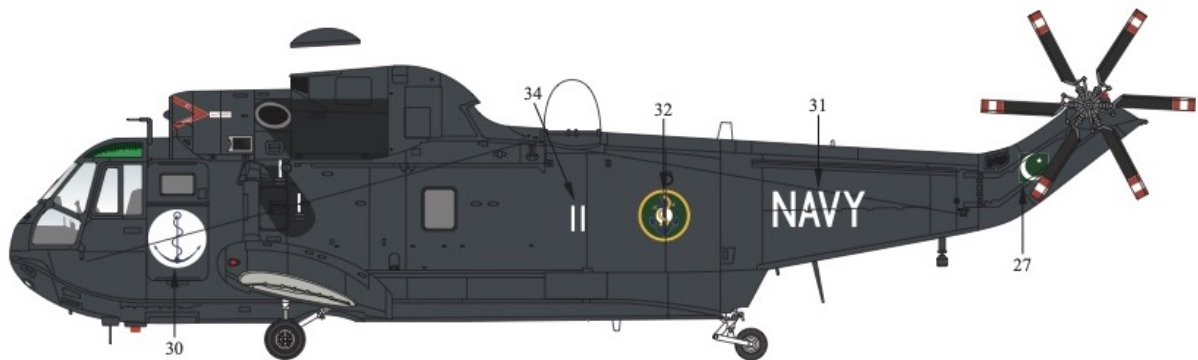

**Modellers Note:**  
 Six bladed tail rotor fitted.

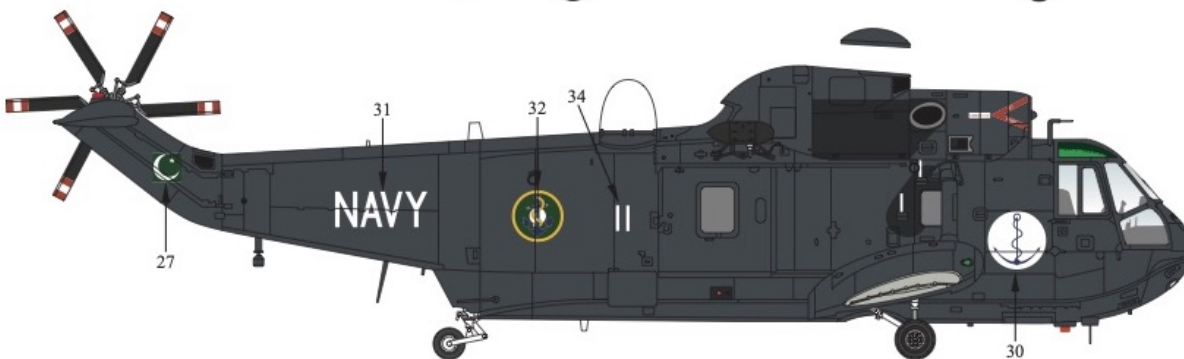



Westland Sea King Mk.50  
 N16-125, '10'  
 of 817 Naval Air Squadron,  
 Royal Australian Navy,  
 1977.

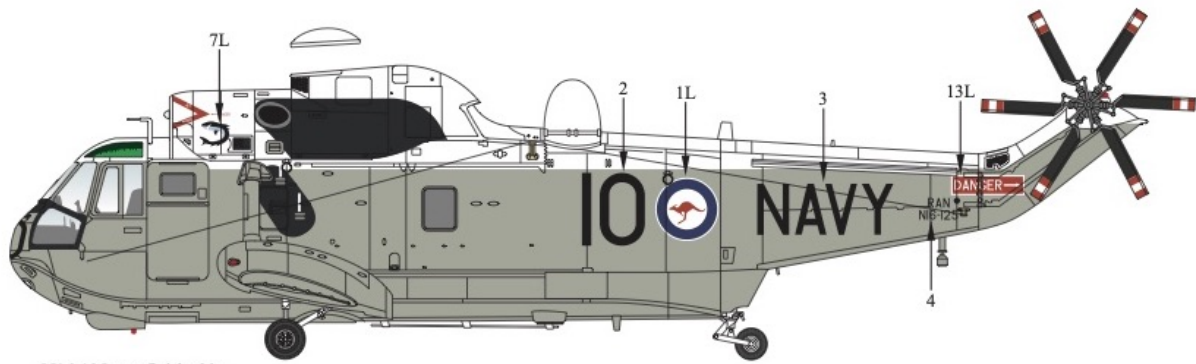

N16-125 was finished in overall Gloss FS16440 Light Gull Grey with the uppersurfaces being Gloss White. Matt BS381C:642 Black exhaust and cockpit glazing areas.

**Modellers Note:**  
 Six bladed tail rotor fitted.



Westland Sea King Mk.48  
 'RS01'  
 of 40 Squadron,  
 Belgian Air Force,  
 2007.

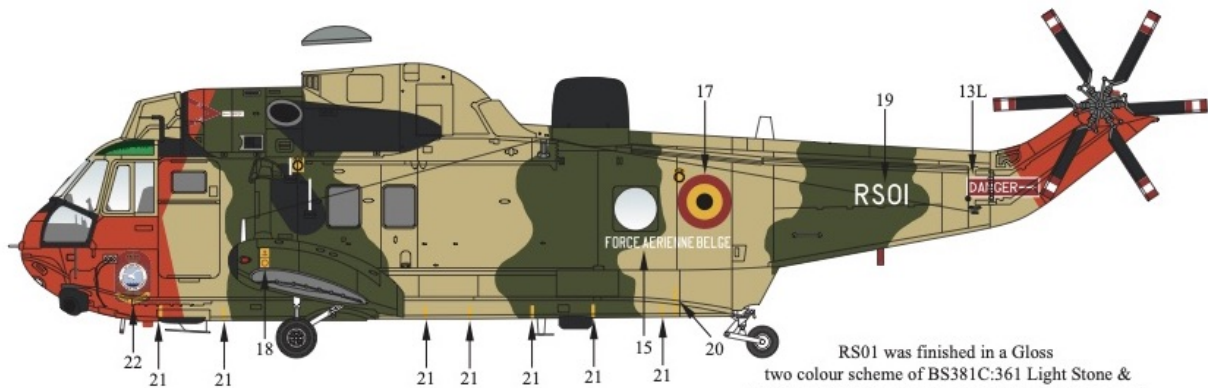

RS01 was finished in a Gloss two colour scheme of BS381C:361 Light Stone & BS381C:220 Olive Green with 'Dockerblaze Orange' tailboom and nose areas. Matt BS381C:642 Black radome, exhaust and cockpit glazing areas.

**Modellers Note:**  
 Six bladed tail rotor fitted.

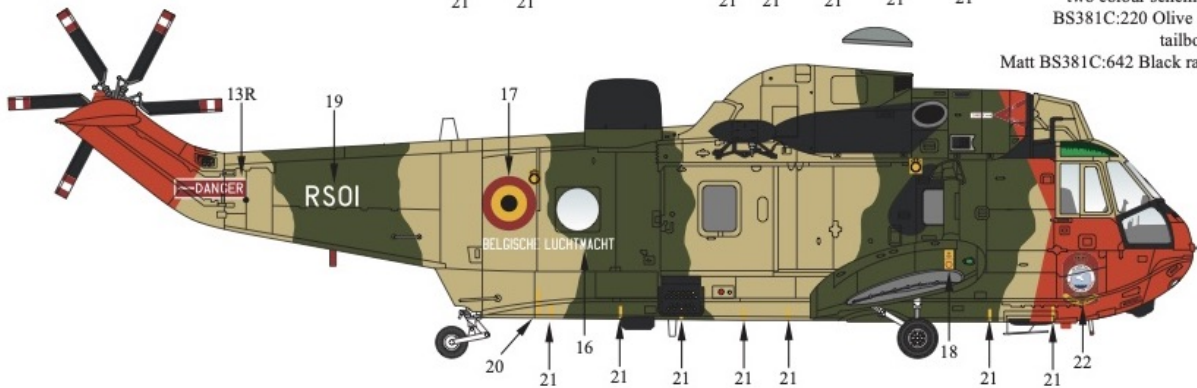

Westland Sea King Mk.42C  
 'IN559'  
 of 40 Squadron,  
 Indian Navy,  
 2007.

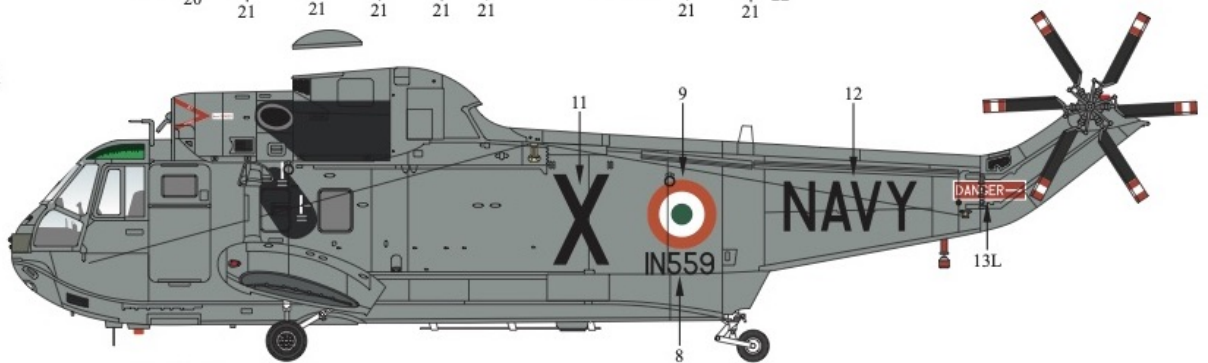

IN559 was finished in overall Satin BS381C:637 Medium Sea Grey. Matt BS381C:642 Black exhaust & step areas.

**Modellers Note:**  
 The sponsons were shortened on the Mk.42 type. Six bladed tail rotor fitted.

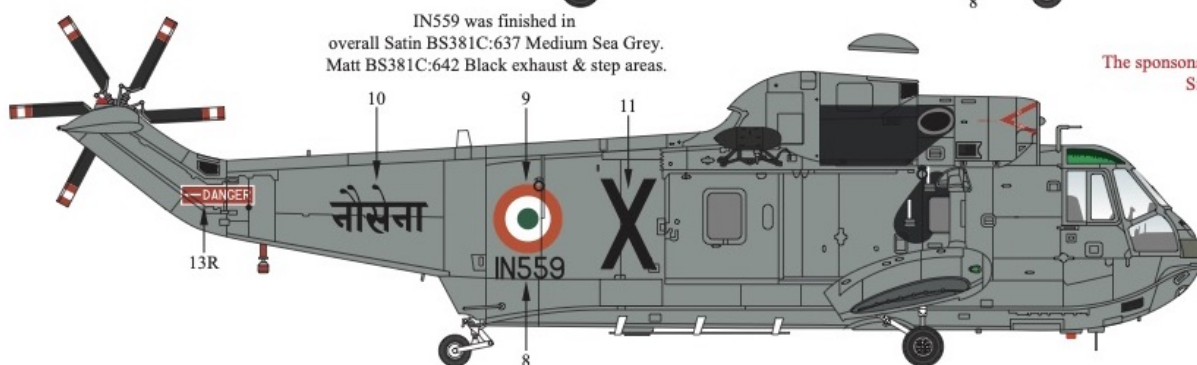



Westland Sea King Mk.41,  
 '89+63',  
 of Marinefliegergeschwader 5,  
 West German Navy,  
 Based at Nordholz NAS,  
 Germany,  
 2023.

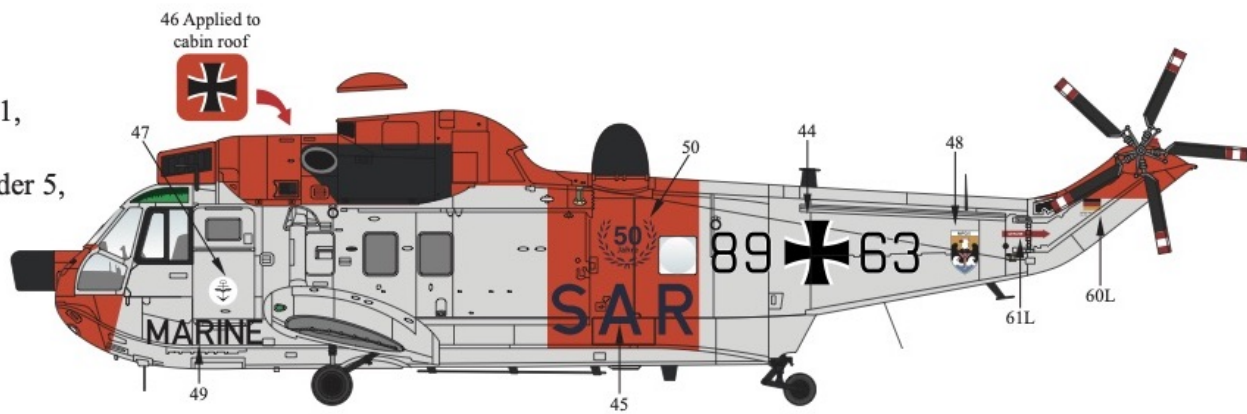

'89+63' was finished in  
 an overall Gloss RAL9001 Weissaluminum with RAL2005 Leuchtorange Orange areas.  
 Matt BS381C:642 Black exhaust and radome cap.

**Modellers Note:**  
 Early five bladed tail rotor fitted.

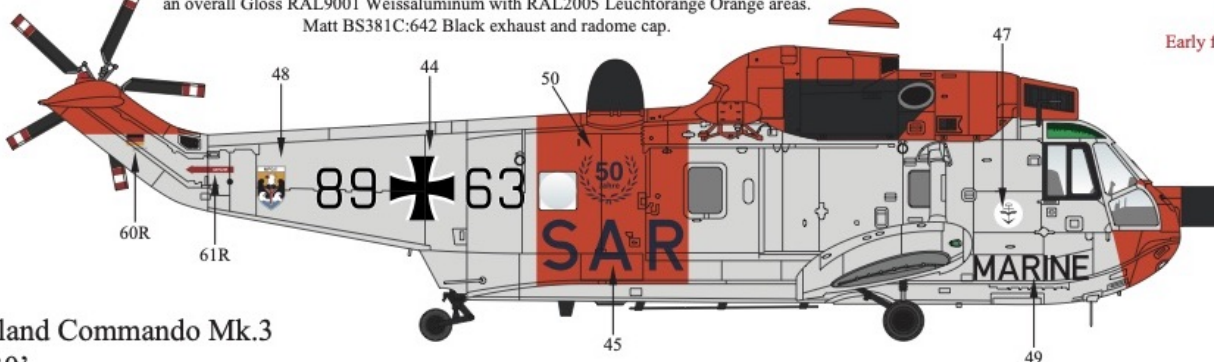

Westland Commando Mk.3  
 'QA30'  
 of No.8 Anti-Surface Vessel  
 Squadron,  
 Qatari Emiri Air Force,  
 2011.

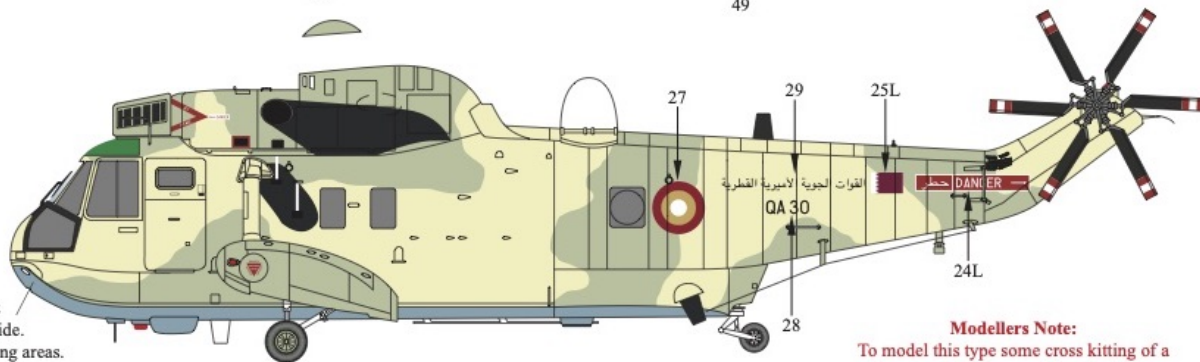

RS01 was finished in a Matt  
 two colour scheme of BS381C:210 Sky &  
 BS381C:365 Vellum with a Sky Blue underside.  
 Matt BS381C:642 Black exhaust and cockpit glazing areas.  
 White radome cap.

**Modellers Note:**  
 To model this type some cross kitting of a  
 Commando airframe with parts from a  
 HAS.1 or HAR.3. Six bladed tail rotor  
 fitted.

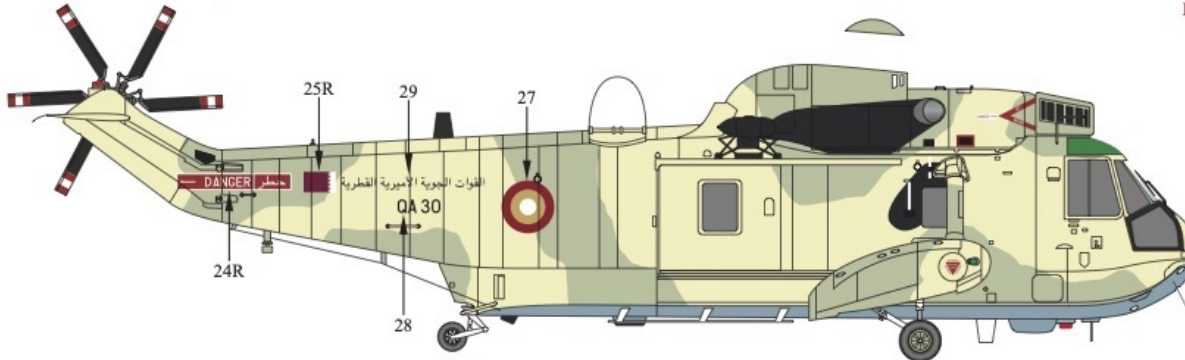

Westland Commando Mk.2  
 '721' of  
 Republic of Egypt Air Force,  
 1980.

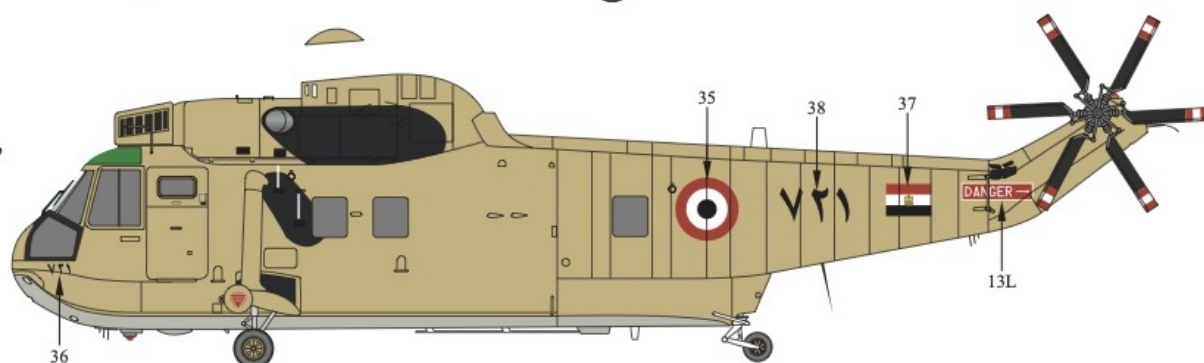

721 was finished in  
 overall Satin BS381C:361 Light Stone over  
 Satin BS381C:627 Light Aircraft Grey undersides.  
 Matt BS381C:642 Black exhaust cockpit glazing surrounds & step areas.

**Modellers Note:**  
 No rear fuselage window blister was fitted to this  
 airframe bu a six bladed tail rotor was fitted.



Westland Sea King Mk.43B,  
 '073' Undersides.

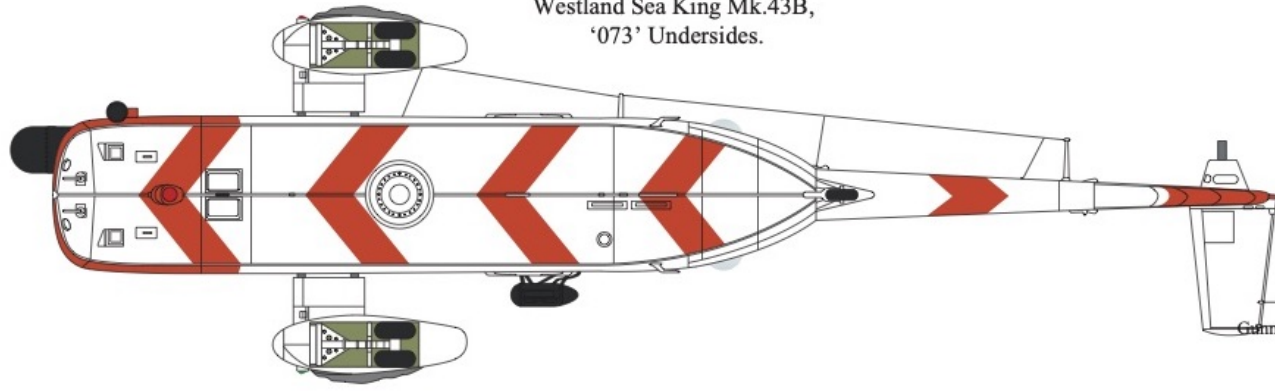

Westland Sea King Mk.50A  
 'N16-118'/'07' Undersides

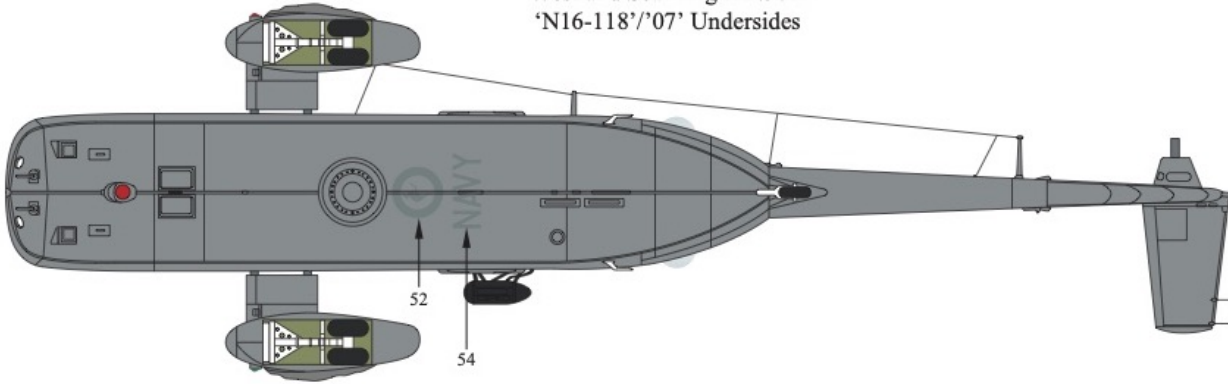

Westland Sea King Mk.41,  
 '89+63' Undersides.

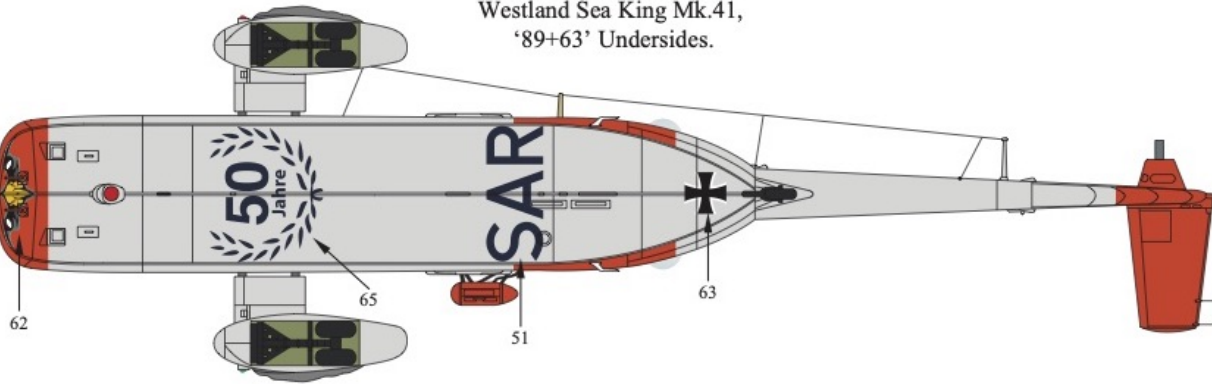

Westland Sea King Mk.50  
 N16-125, '10' Undersides.

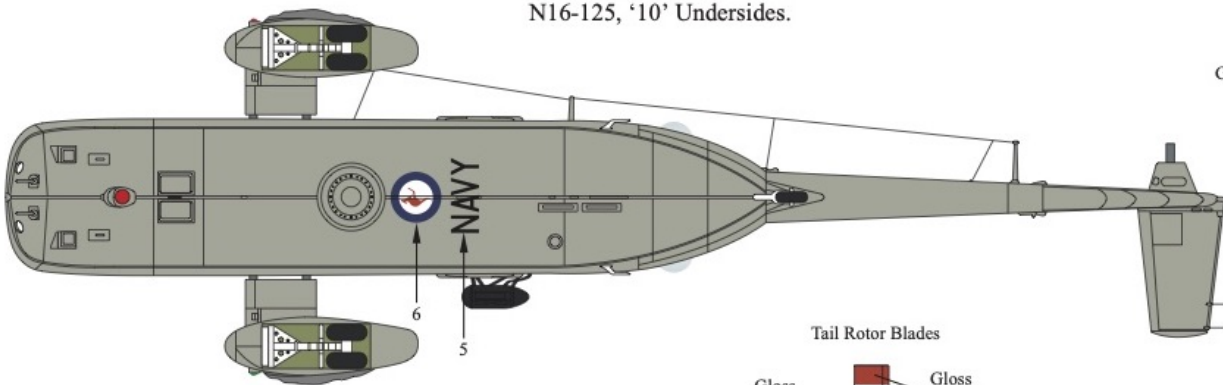

Lowersurfaces of Main  
 Rotor Blades

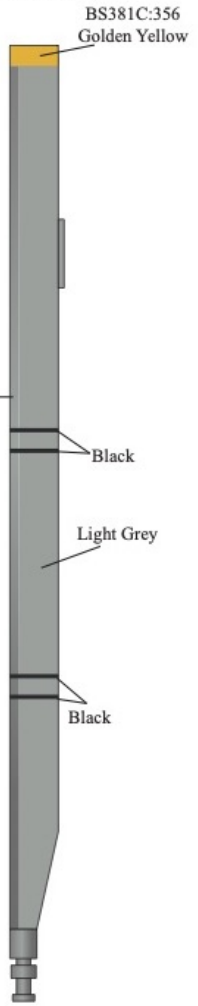

Uppersurfaces of Main  
 Rotor Blades



Tail Rotor Blades

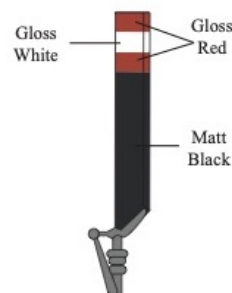



Westland Sea King Mk.50  
 N16-125, '10'.

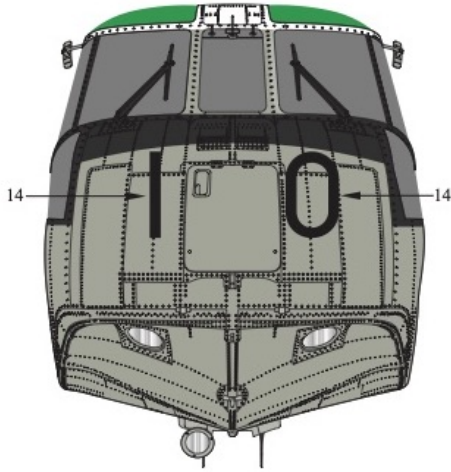

Westland Sea King Mk.48  
 'RS01'.

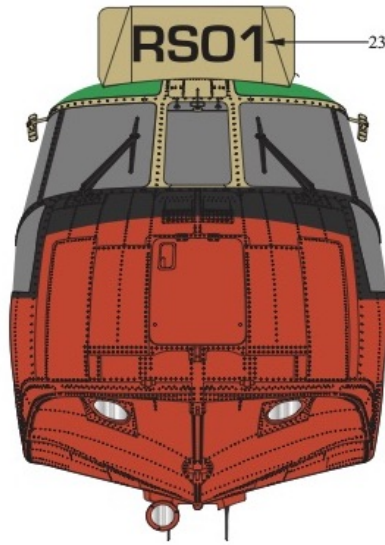

Westland Sea King Mk.42C  
 'IN559'.

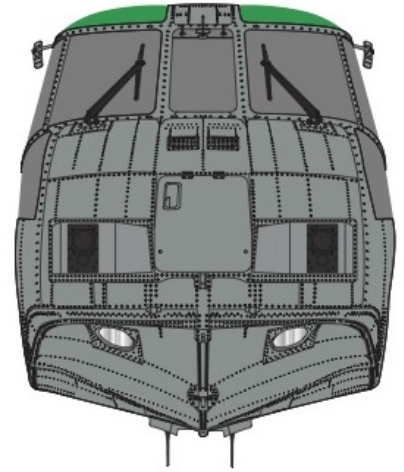

Westland Sea King Mk.45  
 '11'.



Westland Commando Mk.3  
 'QA30'.

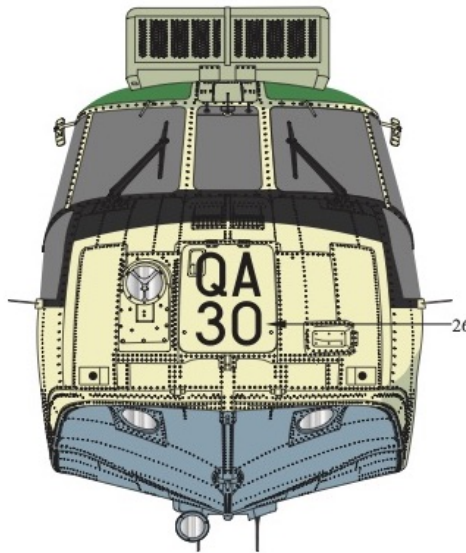

Westland Commando Mk.2  
 '721'.

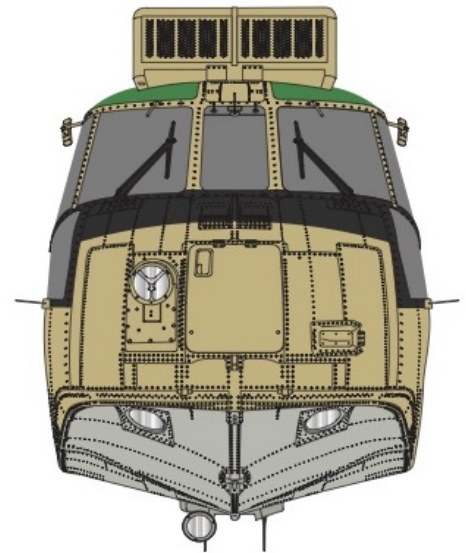

Westland Sea King Mk.43B,  
 '073'.

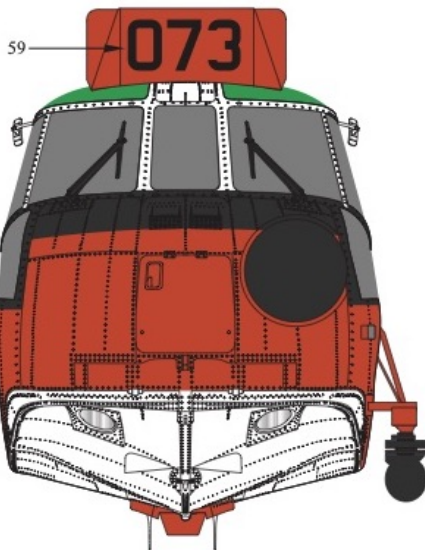

Westland Sea King Mk.50A  
 'N16-118'/'07'.

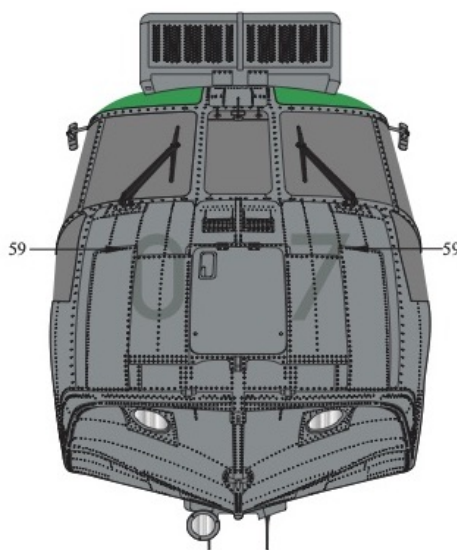

Westland Sea King Mk.41,  
 '89+63'.

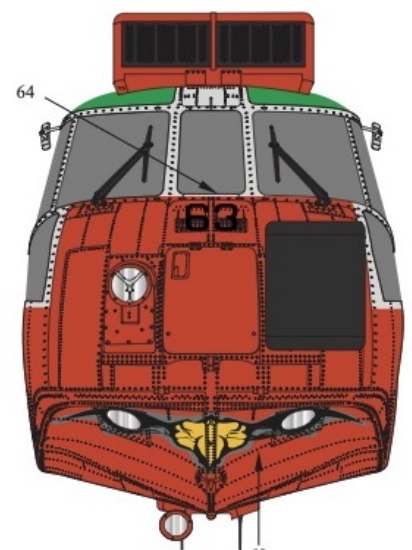

**Xtracolor Paints**

X003 Medium Sea Grey  
 X007 Sky  
 X012 Night Black  
 X013 RAF Blue Grey  
 X015 Light Aircraft Grey  
 X027 Olive Drab  
 X029 Light Stone  
 X135 Dark Compass Grey  
 X137 Light Gull Grey  
 X141 White  
 X501 Silver

**Paints:**

The colours used on these aircraft can be found in the Xtracolor (prefix number with X) and Xtracrylix (prefix number with XA1) range of paints.

**Xtracolor Paints**

XA1003 Medium Sea Grey  
 XA1007 Sky  
 XA1012 Night Black  
 XA1013 RAF Blue Grey  
 XA1015 Light Aircraft Grey  
 XA1027 Olive Drab  
 XA1029 Light Stone  
 XA1135 Dark Compass Grey  
 XA1137 Light Gull Grey  
 XA1141 White