

1/144 SCALE AIRCRAFT SERIES

YF-23 LIGHTNING II

美国YF-23灰魅式战机

部品图
(Parts)

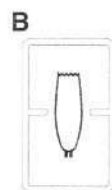
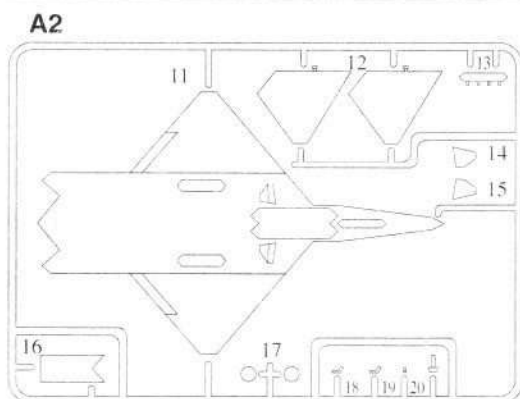
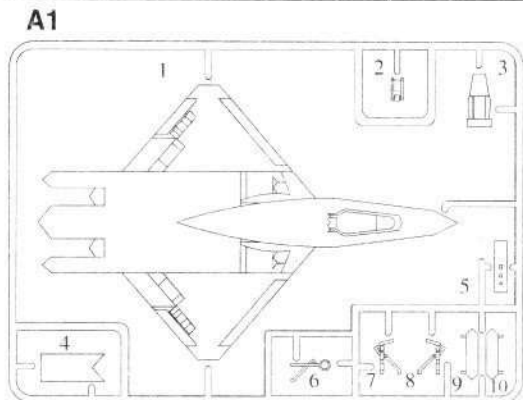

贴纸 (Decal)

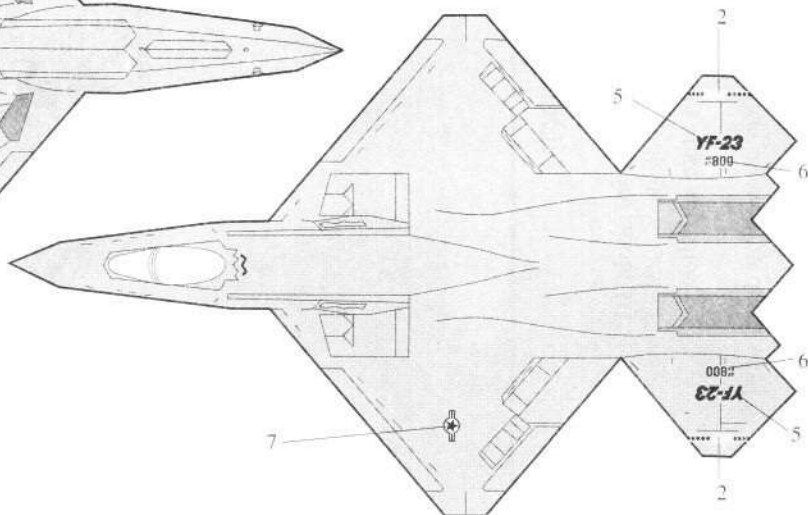
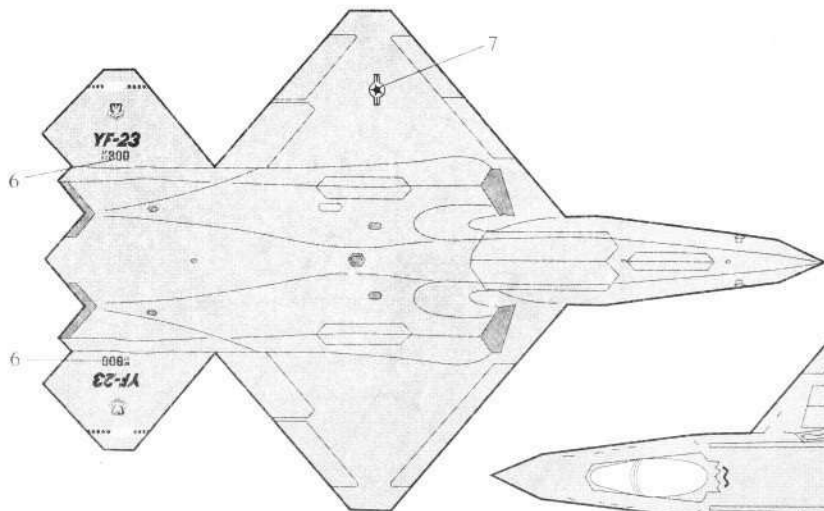
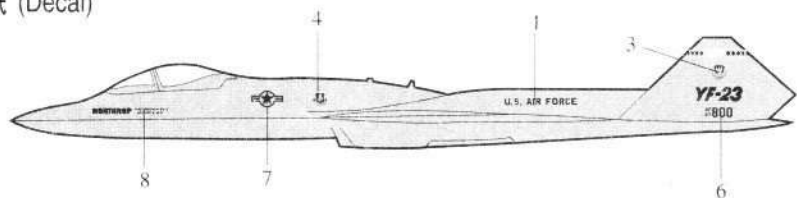

1. 在开始组装你的模型前，请认真阅读此说明书。
 2. 依据安装说明，用钳子或小刀小心地切割下所需部分。
- Read this instruction sheet carefully before you start to assemble your model.
Cut the parts carefully in accordance with the assembling order by use of a nipper or a knife.

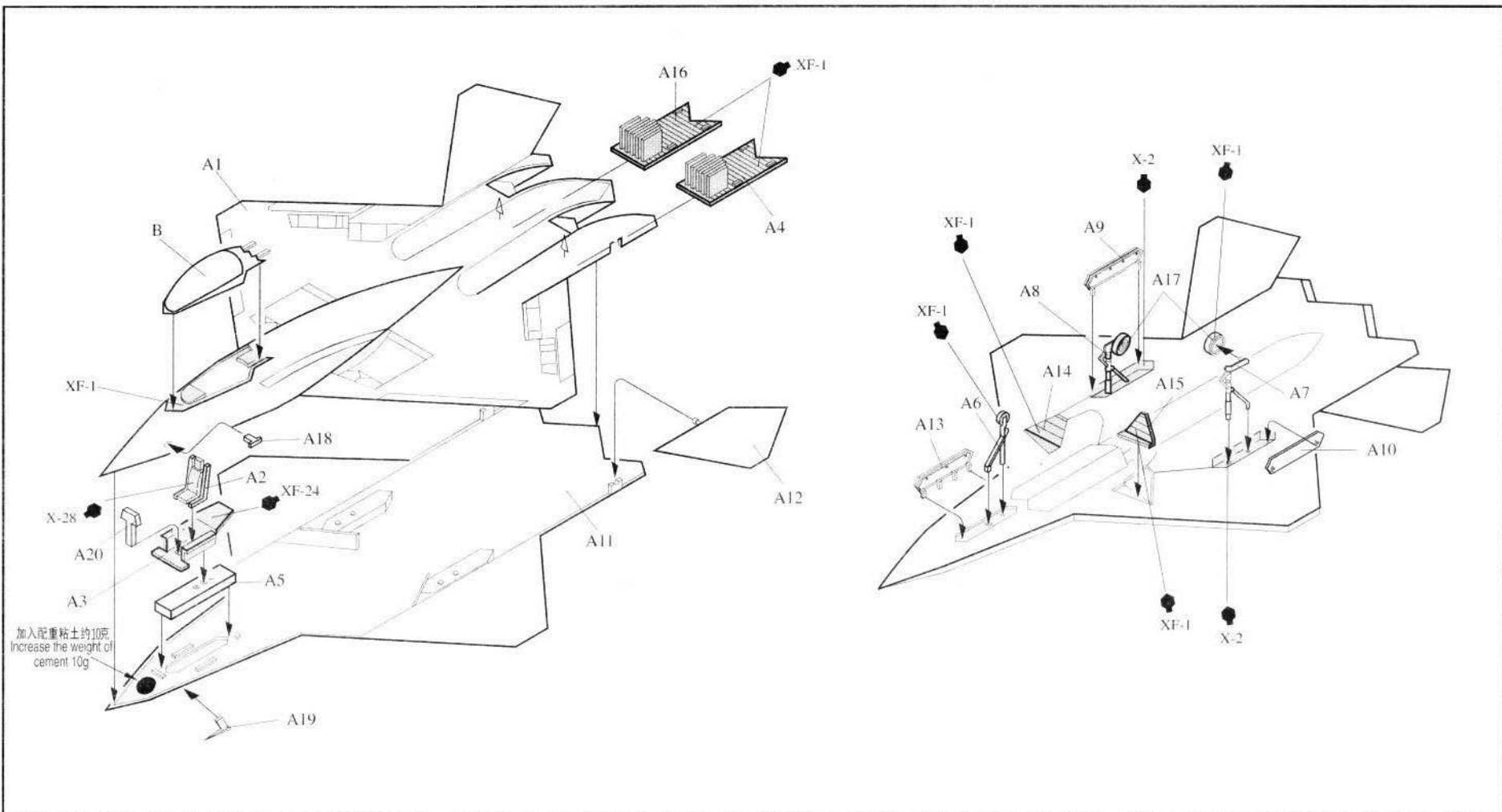

颜色指示 COLORS

X-2	白色	White
X-28	暗绿色	Dark Green
XF-1	哑黑色	Flat Black
XF-24	深灰色	Dark Gray
XF-66	浅灰色	Light Gray

水贴纸的使用:

1. 从水贴纸上剪下印花;
2. 将印花放入温水中浸10秒, 然后放在干净布上。
3. 拿着印花纸板将印花移到模型上;
4. 手指蘸水将印花移到适当的位置;
5. 用软布轻压印花直至水干, 气泡消失。

DECAL APPLICATION

1. Cut off decal from sheet.
2. Dip the decal in tepid water for about 10 sec. and place on a clean cloth.
3. Hold the backing sheet edge and slide decal onto the model.
4. Move decal into position by wetting decal with finger.
5. Press decal gently down with a soft cloth until excess water and air bubbles are gone.