

648 321 Ki-61-Id gun barrels

for Tamiya kit - pro stavebnici Tamiya



1/48 scale

R6 2pcs.

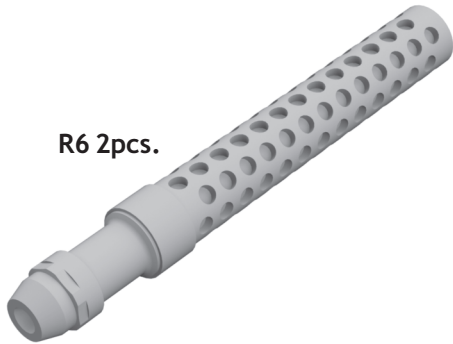

COLOURS

GSI Creos (GUNZE)		Mr.METAL COLOR	
AQUEOUS	Mr.COLOR	MC214	DARK IRON

This product contains metal and resin detail parts for upgrading scale plastic models. When selecting this set make sure that it is for the kit mentioned in product name as these sets are made specifically for that kit. When upgrading the model some cutting or corrections may be necessary for parts to fit accurately. **WARNING!** This set contains small and sharp parts. Work carefully in a ventilated and well-lit room. Safety glasses are recommended. This product is not suitable for children below 14 years of age.

Tento výrobek obsahuje leptané a odlévané detaily pro úpravu a vylepšení plastického modelu. Při výběru sady kovových detailů zkontrolujte, zda je určena pro model, který chcete upravit. Model, pro který je sada určena, je uveden u názvu výrobku. Pro přesnou aplikaci kovových a odlévaných dílů může být zapotřebí upravit díly upravovaného modelu. **POZOR!** Sada obsahuje malé ostré díly. Pracujte ve větrané a dobře osvětlené místnosti. Doporučujeme použití ochranných brýlí. Tento výrobek není vhodný pro děti mladší 14 let.



435 21 Obrnice 170
Czech Republic



www.eduard.com









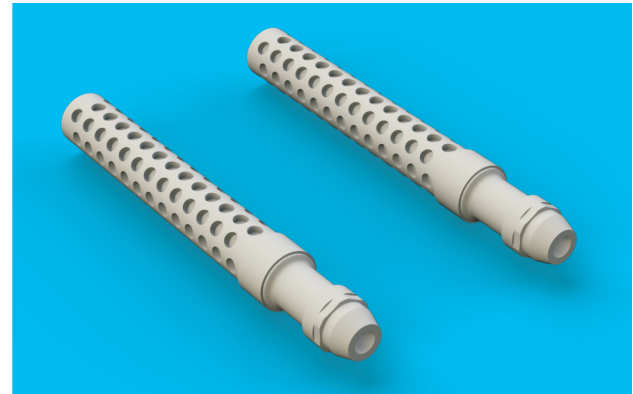
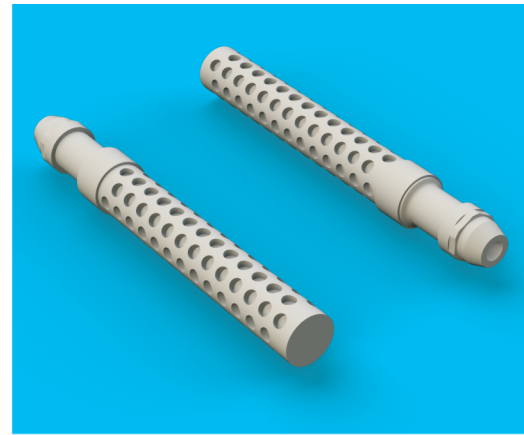

648 321 Ki-61-Id gun barrels

for Tamiya kit - pro stavebnici Tamiya

1/48



BEST ~~BRASS~~ RESIN AROUND!

-  REMOVE
ODSTRANIT
-  BEND
OHNOUT
-  GRIND
OBROUSIT
-  OPTION
VOLBA
-  DRILL HOLE
VRTÁT OTVOR
-  REPLACE
NAHRADIT
-  SYMMETRICAL ASSEMBLY
SYMETRICKÁ MONTÁŽ
-  SCRIBE THE PANEL AND HOLES
RYTI
-  REVERSE SIDE
OTOČIT

 = 

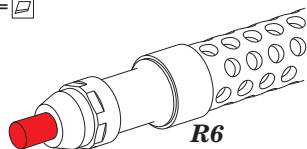

 = 

$\varnothing - 0,4mm$
 $l - 0,4mm$

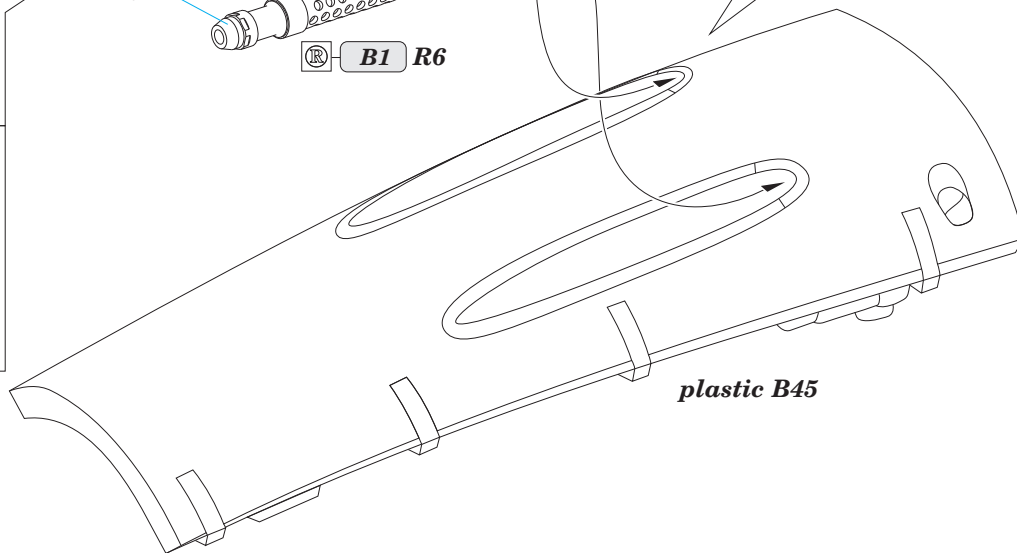
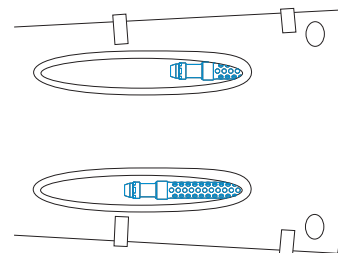
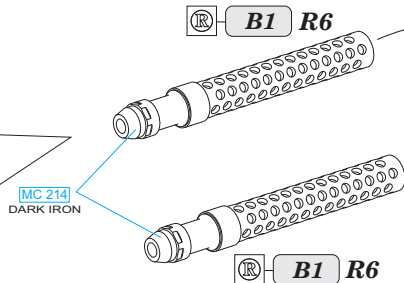
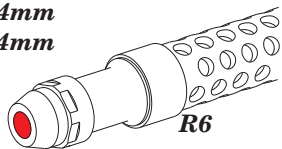

648 317 Ki-61-Id wheels

for Tamiya kit - pro stavebnici Tamiya



1/48 scale

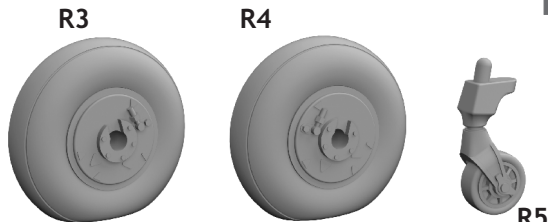
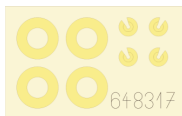

COLOURS		
GSI Creos (GUNZE)		
AQUEOUS	Mr.COLOR	Mr.METAL COLOR
[H 8]	[C 8]	SILVER
[H77]	[C137]	TIRE BLACK
[H81]	[C55]	KHAKI
	[C92]	SEMI GLOSS BLACK

This product contains metal and resin detail parts for upgrading scale plastic models. When selecting this set make sure that it is for the kit mentioned in product name as these sets are made specifically for that kit. When upgrading the model some cutting or corrections may be necessary for parts to fit accurately. **WARNING!** This set contains small and sharp parts. Work carefully in a ventilated and well-lit room. Safety glasses are recommended. This product is not suitable for children below 14 years of age.

Tento výrobek obsahuje leptané a odlévané detaily pro úpravu a vylepšení plastického modelu. Při výběru sady kovových detailů zkontrolujte, zda je určena pro model, který chcete upravit. Model, pro který je sada určena, je uveden u názvu výrobku. Pro přesnou aplikaci kovových a odlévaných dílů může být zapotřebí upravit díly upravovaného modelu. **POZOR!** Sada obsahuje malé ostré díly. Pracujte ve větrané a dobře osvětlené místnosti. Doporučujeme použít ochranných brýlí. Tento výrobek není vhodný pro děti mladší 14 let.



435 21 Obrnice 170
Czech Republic



www.eduard.com



648 317 Ki-61-Id wheels

for Tamiya kit - pro stavebnici Tamiya

1/48

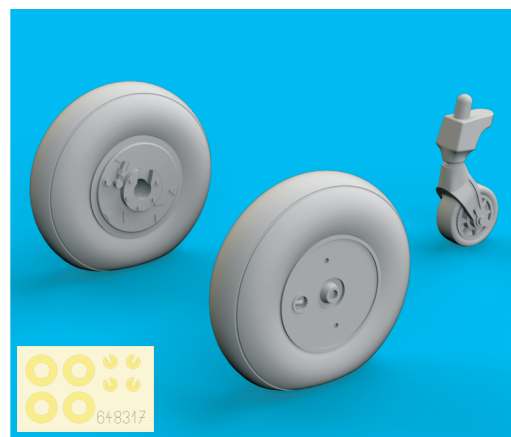

BEST BRASS RESIN AROUND!

- | | | |
|---------------------------|---------------------|---|
| REMOVE
ODSTRANIT | BEND
OHNOUT | SYMMETRICAL ASSEMBLY
SYMETRICKA MONTAZ |
| GRIND
OBROUSIT | OPTION
VOLBA | SCRIBE THE PANEL AND HOLES
RYTI |
| DRILL HOLE
VRTAT OTVOR | REPLACE
NAHRADIT | REVERSE SIDE
OTOČIT |

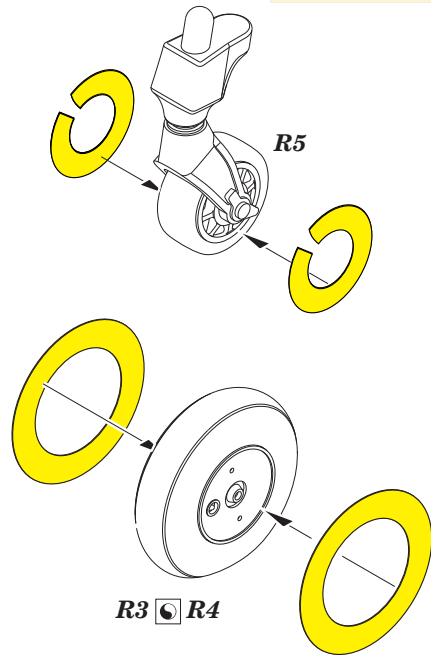
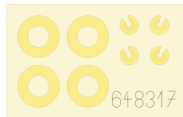

R3 - LEFT WHEEL
R4 - RIGHT WHEEL

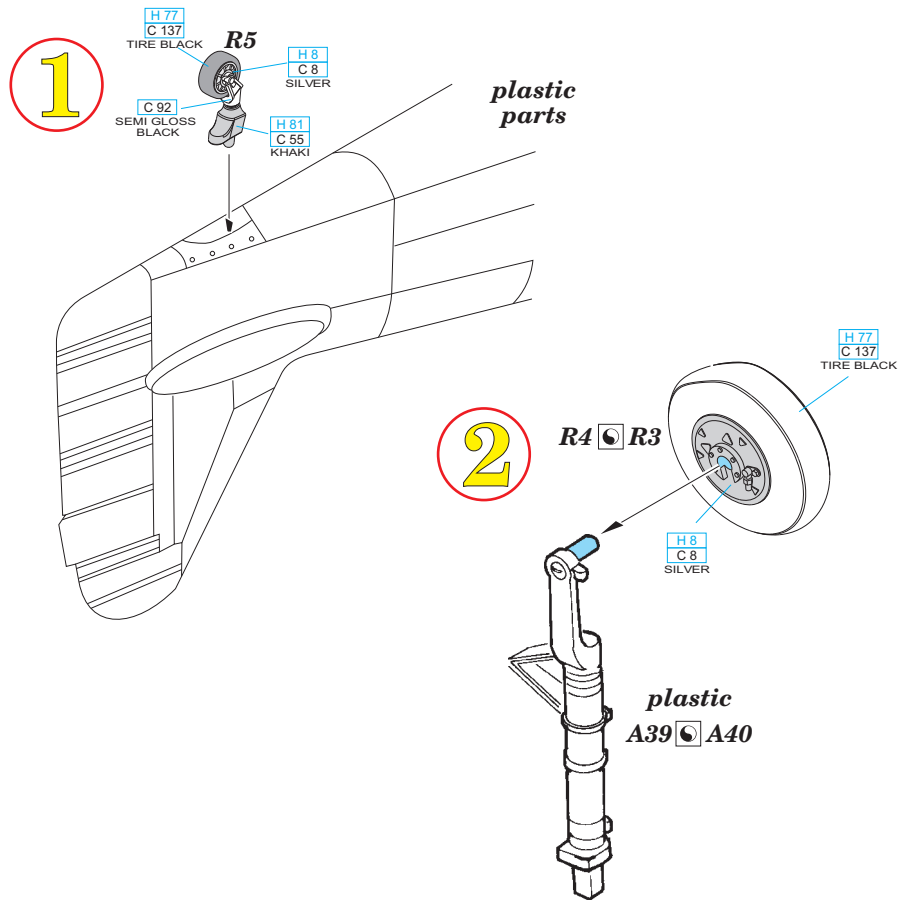

648 443 Ki-61-I fuel tanks

for Tamiya kit - pro stavebnici Tamiya

eduard
BRASSIN

1/48 scale

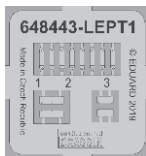
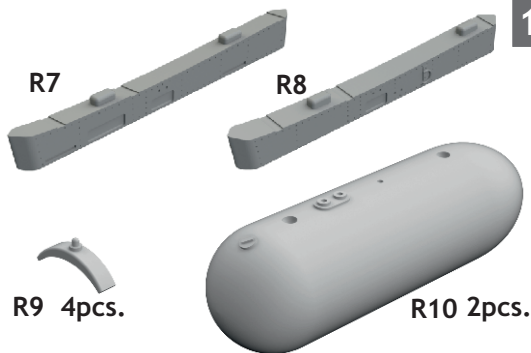

COLOURS

GSI Creos (GUNZE)		Mr.METAL COLOR	
AQUEOUS	Mr.COLOR		
H 8	C 8	SILVER	
	C92	SEMI GLOSS BLACK	
	C128	GRAY GREEN	
		SM01	SUPER CHROME

This product contains metal and resin detail parts for upgrading scale plastic models. When selecting this set make sure that it is for the kit mentioned in product name as these sets are made specifically for that kit. When upgrading the model some cutting or corrections may be necessary for parts to fit accurately. **WARNING!** This set contains small and sharp parts. Work carefully in a ventilated and well-lit room. Safety glasses are recommended. This product is not suitable for children below 14 years of age.

Tento výrobek obsahuje leptané a odlévané detaily pro úpravu a vylepšení plastického modelu. Při výběru sady kovových detailů zkontrolujte, zda je určena pro model, který chcete upravit. Model, pro který je sada určena, je uveden v názvu výrobku. Pro přesnou aplikaci kovových a odlévaných dílů může být zapotřebí upravit díly upravovaného modelu. **POZOR!** Sada obsahuje malé ostré díly. Pracujte ve větrané a dobře osvětlené místnosti. Doporučujeme použití ochranných brýlí. Tento výrobek není vhodný pro děti mladší 14 let.

eduard

www.eduard.com

435 21 Obrnice 170
Czech Republic

14,95



648 443 Ki-61-I fuel tanks

for Tamiya kit - pro stavebnici Tamiya

1/48

BRASSIN

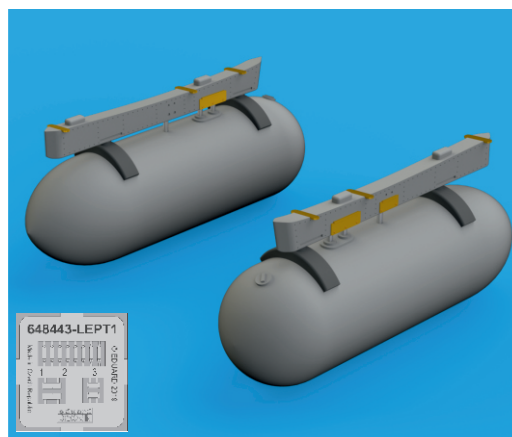

BRASSIN

eduard

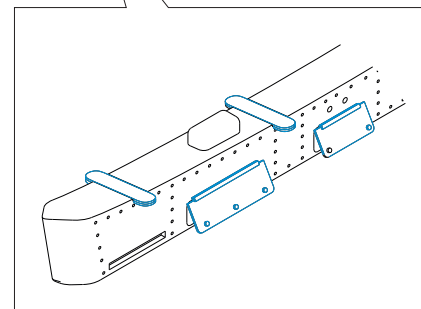
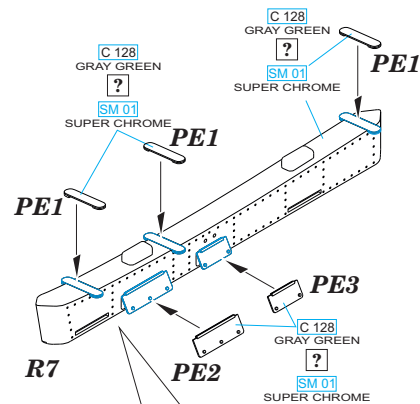
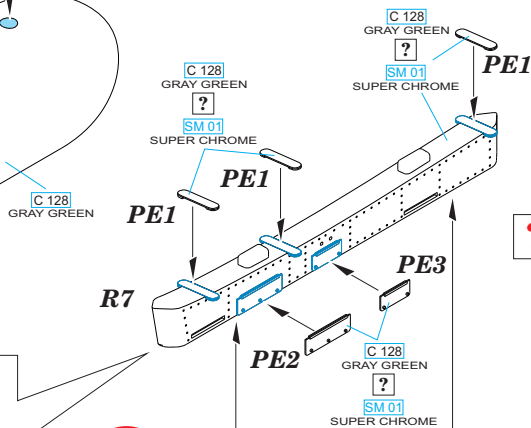
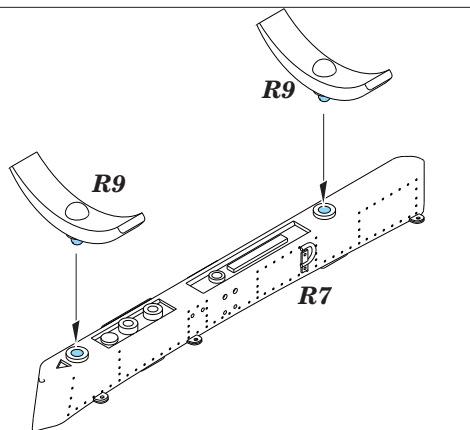
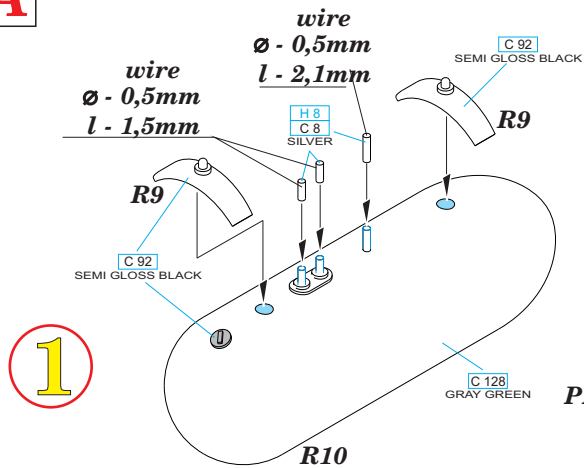

BEST BRASS RESIN AROUND!

A

B

wire
 Ø - 0,5mm
 l - 1,5mm

wire
 Ø - 0,5mm
 l - 2,1mm

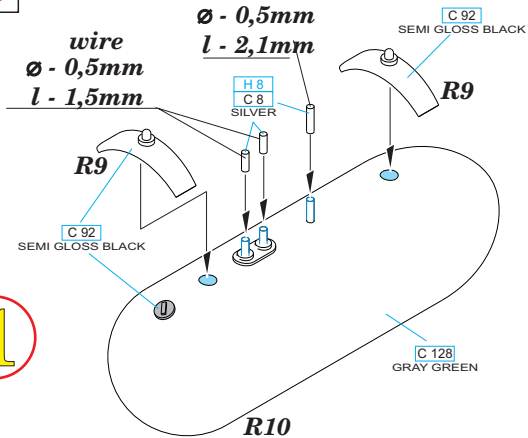
1

- | | | |
|---------------------------|---------------------|---|
| REMOVE
ODSTRANIT | BEND
OHNOUT | SYMMETRICAL ASSEMBLY
SYMETRICKÁ MONTÁŽ |
| GRIND
OBROUSIT | ? OPTION
VOLBA | V SCRIBE THE PANEL AND HOLES
RYTI |
| DRILL HOLE
VRTAT OTVOR | REPLACE
NAHRADIT | REVERSE SIDE
OTOCIT |

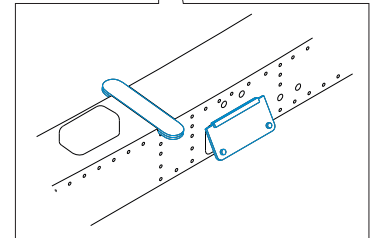
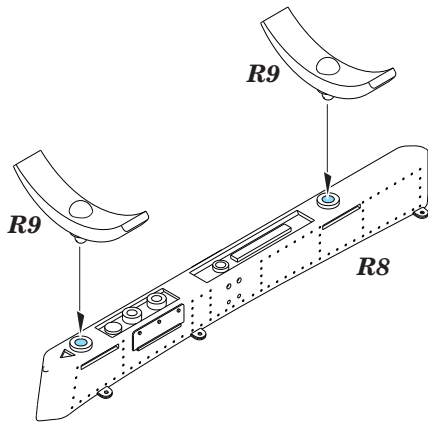
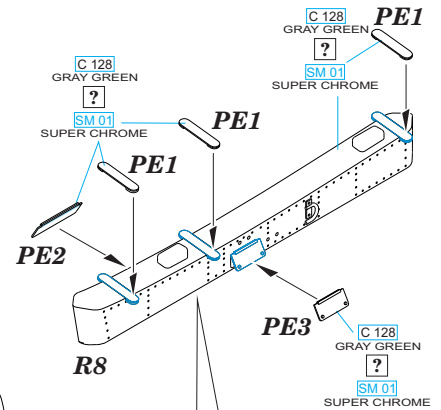
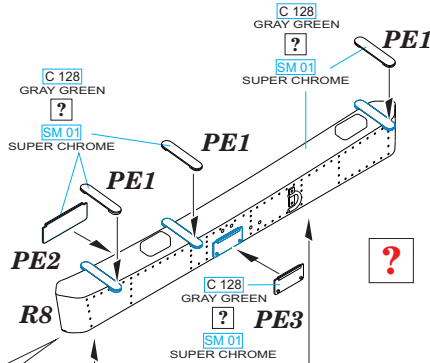
2



plastic A35

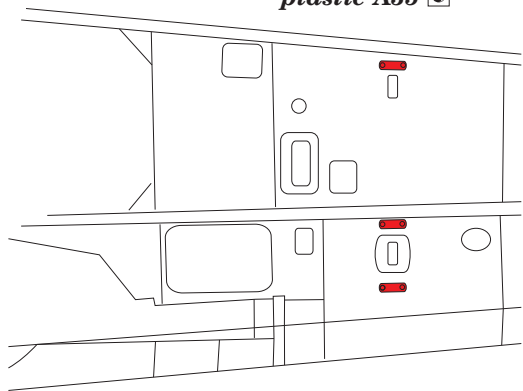

**CORRECT POSITION
OF TANKS**

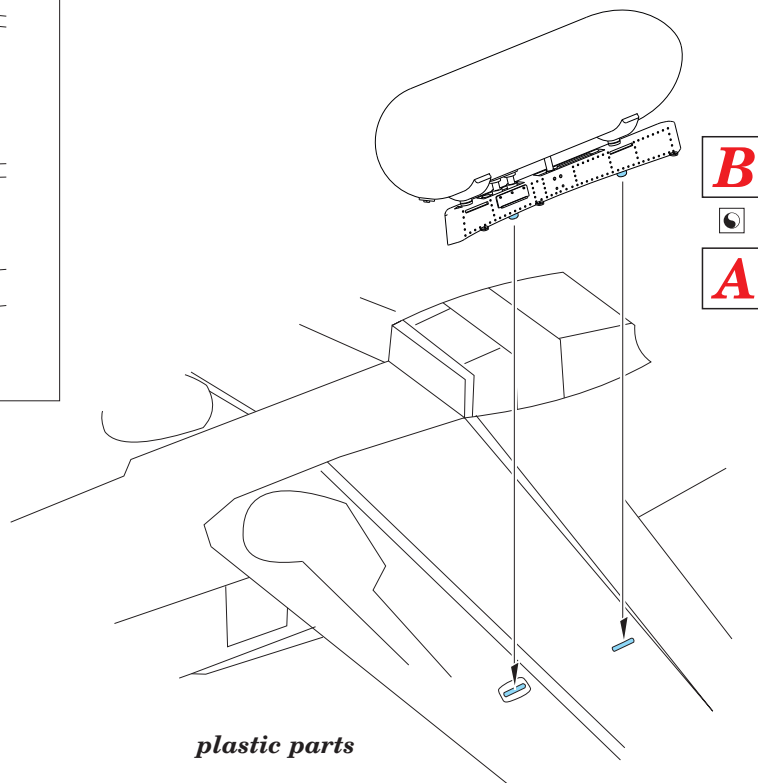
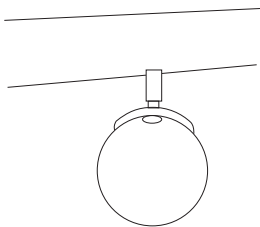

plastic parts

648 316 Ki-61-IId exhaust stacks

for Tamiya kit - pro stavebnici Tamiya



1/48 scale

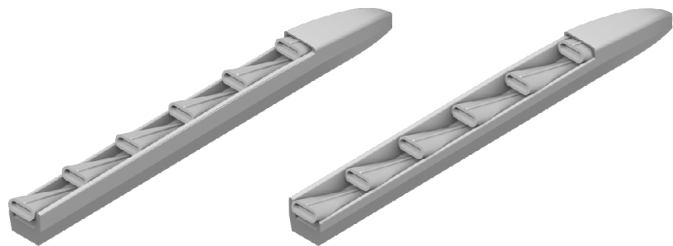

COLOURS

GSI Creos (GUNZE)		Mr.METAL COLOR	
AQUEOUS	Mr.COLOR	MC214	DARK IRON

This product contains metal and resin detail parts for upgrading scale plastic models. When selecting this set make sure that it is for the kit mentioned in product name as these sets are made specifically for that kit. When upgrading the model some cutting or corrections may be necessary for parts to fit accurately. **WARNING!** This set contains small and sharp parts. Work carefully in a ventilated and well-lit room. Safety glasses are recommended. This product is not suitable for children below 14 years of age.

Tento výrobek obsahuje leptané a odlévané detaily pro úpravu a vylepšení plastického modelu. Při výběru sady kovových detailů zkontrolujte, zda je určena pro model, který chcete upravit. Model, pro který je sada určena, je uveden u názvu výrobku. Pro přesnou aplikaci kovových a odlévaných dílů může být zapotřebí upravit díly upravovaného modelu. **POZOR!** Sada obsahuje malé ostré díly. Pracujte ve větrané a dobře osvětlené místnosti. Doporučujeme použití ochranných brýlí. Tento výrobek není vhodný pro děti mladší 14 let.



435 21 Obrnice 170
Czech Republic



www.eduard.com



648 316 Ki-61-IId exhaust stacks 1/48

for Tamiya kit - pro stavebnici Tamiya

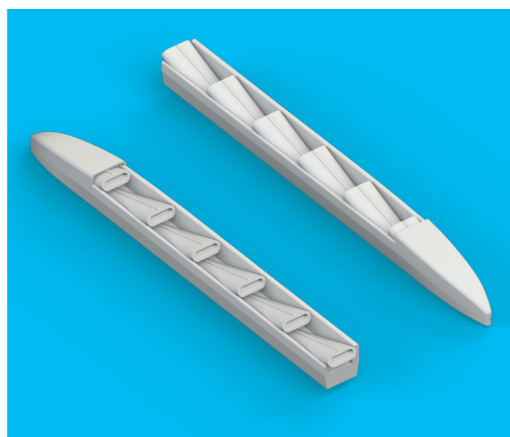

eduard

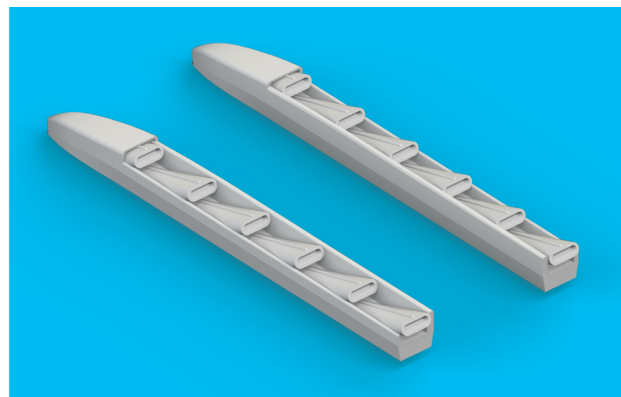

BEST ~~BRASS~~ RESIN AROUND!

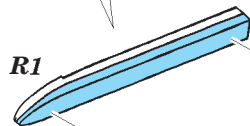
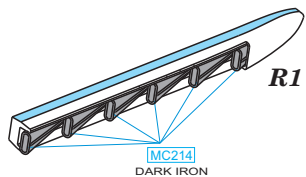

plastic parts

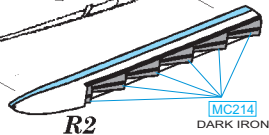

	REMOVE ODSTRANIT		BEND OHNOUT		SYMMETRICAL ASSEMBLY SYMETRICKÁ MONTÁŽ
	GRIND OBROUSIT		OPTION VOLBA		SCRIBE THE PANEL AND HOLES RYTI
	DRILL HOLE VRTÁT OTVOR		REPLACE NAHRADIT		REVERSE SIDE OTOČIT