

Assembly Instructions • Instructions de Montage

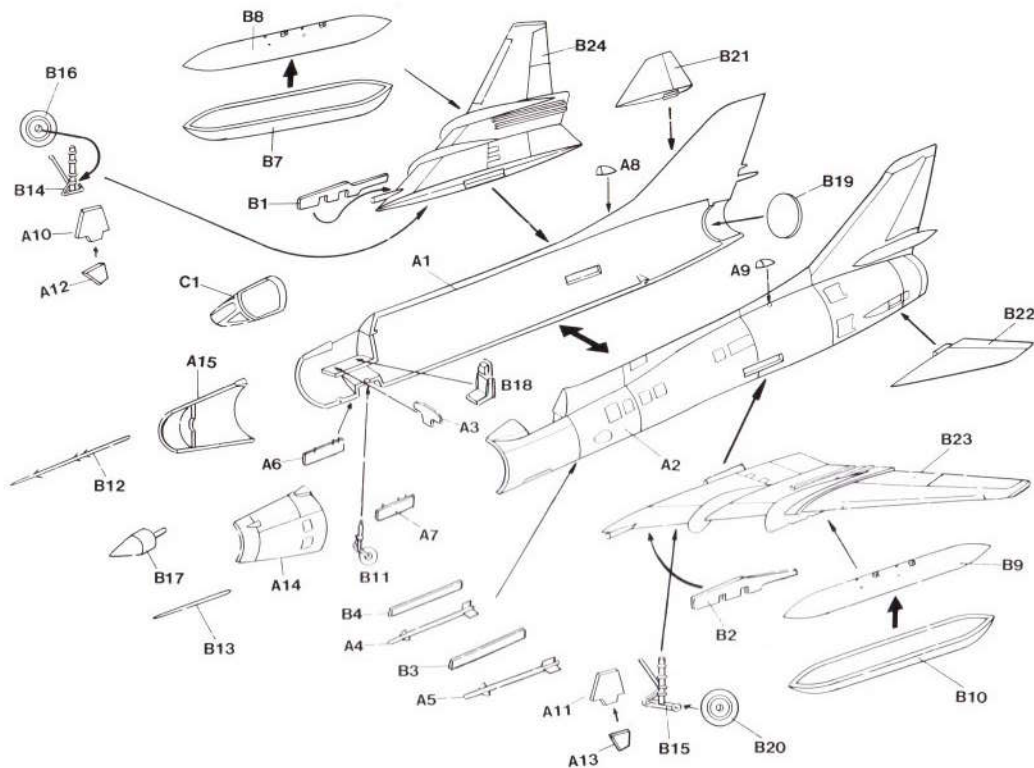

Read This Before You Begin!

- study the assembly drawings
 - each plastic part is identified by number
 - check the fit of each piece before cementing
 - do not use too much cement to join parts
 - model may be painted to match box illustration
- Lisez Ce Qui Suit Avant De Commencer Le Montage!
- étudier les schémas d'assemblage
 - chaque pièce plastique porte un numéro d'identification
 - contrôler que chaque pièce soit bien conforme avant de la coller à sa place
 - utilisez uniquement une colle spéciale pour polystyrène
 - le modèle peut être peint conformément aux illustrations de la boîte
- Vor Zusammenbau lesen Sie bitte!
- studiere die Bauanleitung
 - die Plastikteile sind gekennzeichnet durch ihre Nummern
 - vor dem Kleben prüfe ob die Teile zusammenpassen können
 - benutze nicht zuviel Klebstoff
 - die Bemalung des Modells kann auf dem Becketbild zeigen

Su-17 Fitter C

Markings • Appliques

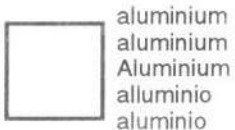
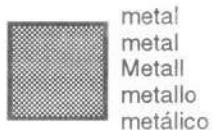

USSR, 1980

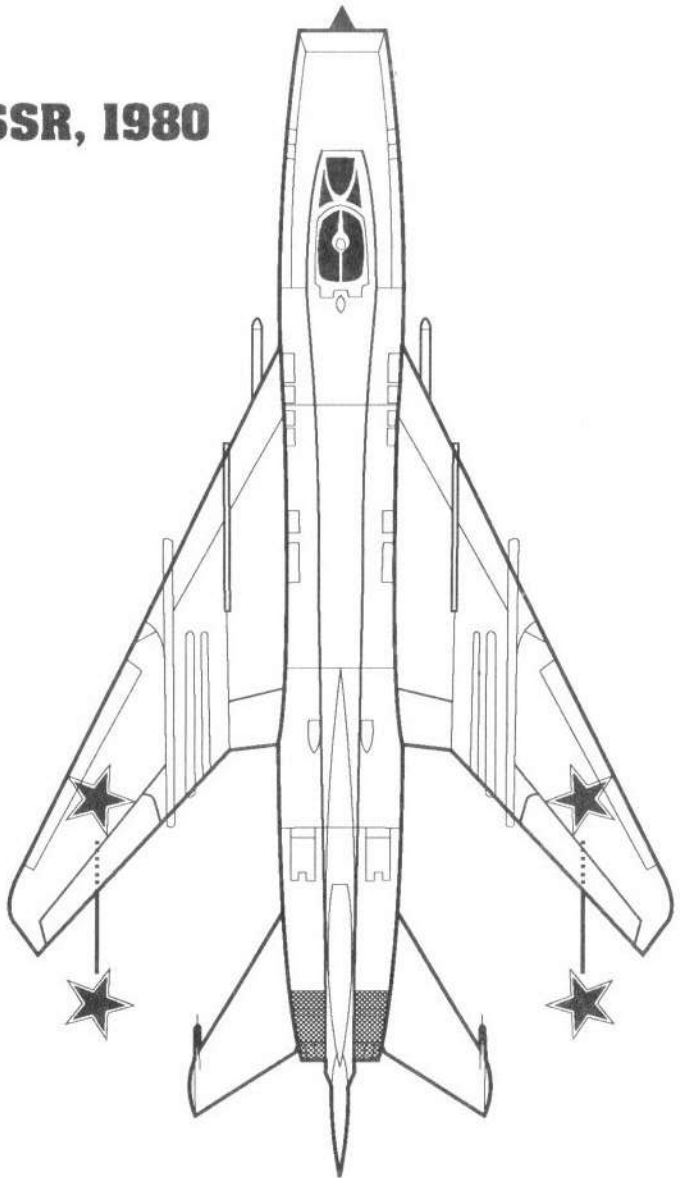

HC1019 Su-17 Fitter C

Markings • Appliques

BRITAIN

"CAUTION: NOT SUITABLE FOR CHILDREN UNDER 3 YEARS. CONTAINS SMALL PARTS."

FRANCE

CERTAINS PRODUITE CONTIENNENT DES PIECES DE PETITE DIMENSION QUI NE CONVIENT PAS A UN ENFANT DE MOINS DE 36 MOIS.

GERMANY

VORSICHT: NICHT FÜR KINDER UNTER 36 MONATEN—ERTHÄLT KLEINE TEILE.

ITALY

PRODOTTO NON ADATTO AI BAMBINI DI ETA INFERIORE AI 36 MESI. CONTIENE PICCOLLO OGGETTI.

HOLLAND

KAN GEVAAR OPLEVEREN VOOR KINDEREN TOT 3 JAAR. BEVAT KLEINE UNDERDELEN.

PORTUGAL

ATENCAO: IMPRÓPRIO PARA CRIANCAS COM MENOS DE 3 ANOS. CONTÉM PECAS PEQUENAS.

SPAIN

ATENCION: NO ES CONVENIENTE PARA NINOS MENORES DE 3 ANOS. CONTIENE PIEZAS PEQUENAS.

DENMARK

FORSIGTIGI IKKE EGNET TIL BORN UNER 3 AR. INDEHOLDER SMA DELE.

GREECE

ΠΡΟΣΟΧΗ: ΔΕΝ ΕΙΝ ΕΙΝΑΙ ΚΑΤΑΛΛΗΛΟ ΓΙΑ ΠΑΙΔΙΑ ΚΑΤΩ ΤΩΝ ΤΡΙΩΝ ΕΤΩΝ ΠΕΡΙΕΧΕΙ ΜΙΚΡΑ ΤΕΜΑΧΙΑ.

cyanoacrylate glue collier cyanoacrylate Cyanocrylate Kleben incollare cyanoacrylate pegar cyanoacrylate	cut couper schneiden tagliare cortar	bend plier bich biegen pregar dobrar	file / sand ponce verschleimen liquare lijar	weight a l'essai Gewicht zavora lastre	drill or pierce percer bohren forare agujerar	x2 two deux zwei due dos
1 photoetched photogravées Photoätzmas foto incise litografiadas	caution! attention! vorachien! attenzione! atenção	alternative en option Alternativ alternativa alternativa	cement collet Kleben incollare pegar	paint peindre bemalen vermoozen pintar	decal Decalcomania Abklebmas decalcomania calcomanias	no! no! nein! no! no!

Su-17 Fitter C

Markings • Appliques

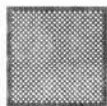

metal
metal
Metall
metallo
metálico

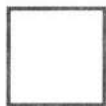

aluminium
aluminium
Aluminium
alluminio
aluminio

Poland, 1980

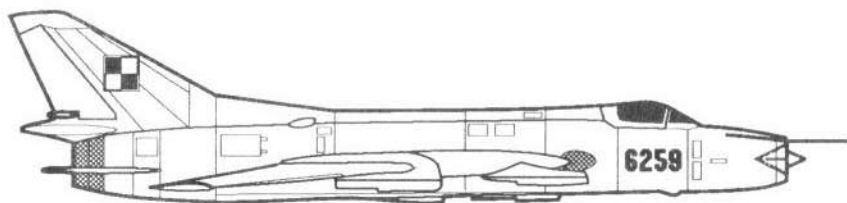
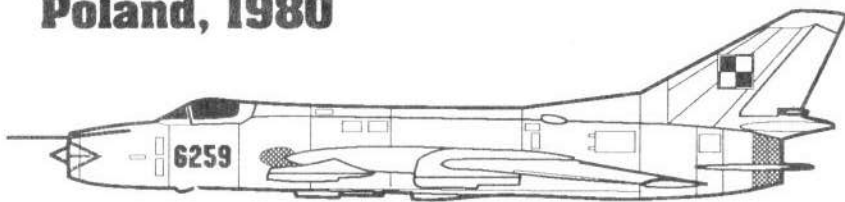

USSR, 1980

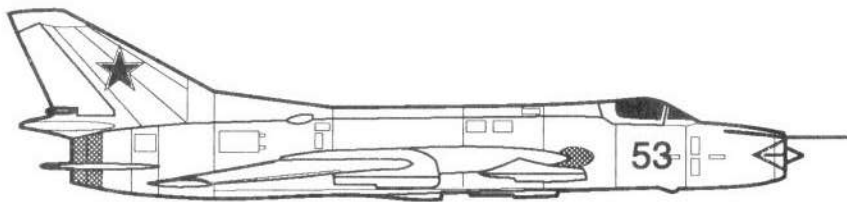
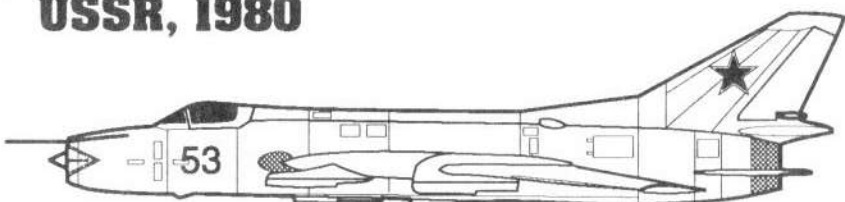

Su-17 Fitter C

Markings • Appliques

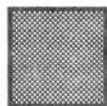

metal
metal
Metall
metallo
metálico

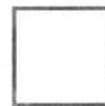

aluminium
aluminium
Aluminium
alluminio
aluminio

Poland, 1980

