

MESSERSCHMITT ME 262A/AVIA S-92

INTERCEPTOR



MKM144115
1/144 scale

plastic parts

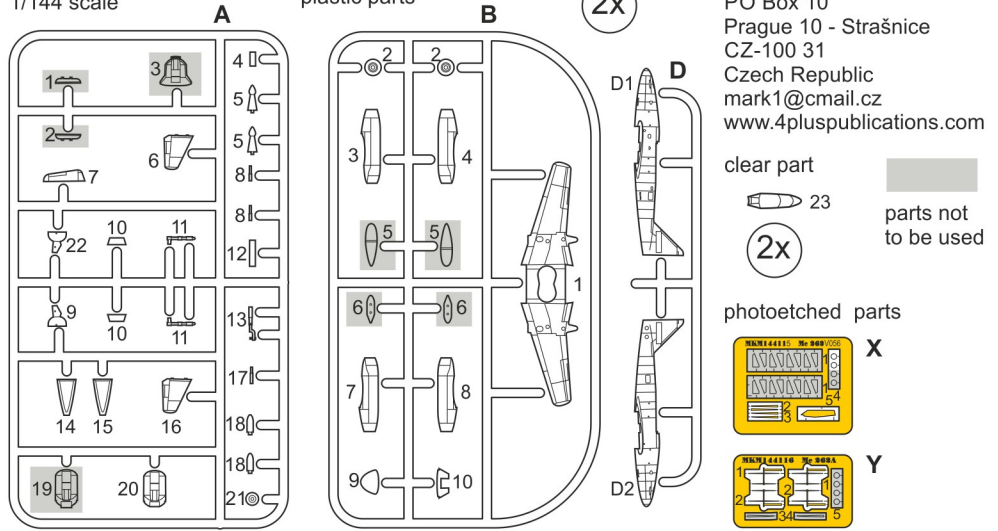

MARK I Ltd.
PO Box 10
Prague 10 - Strašnice
CZ-100 31
Czech Republic
mark1@cmail.cz
www.4pluspublications.com

clear part



parts not to be used



photoetched parts



X

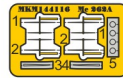

Y

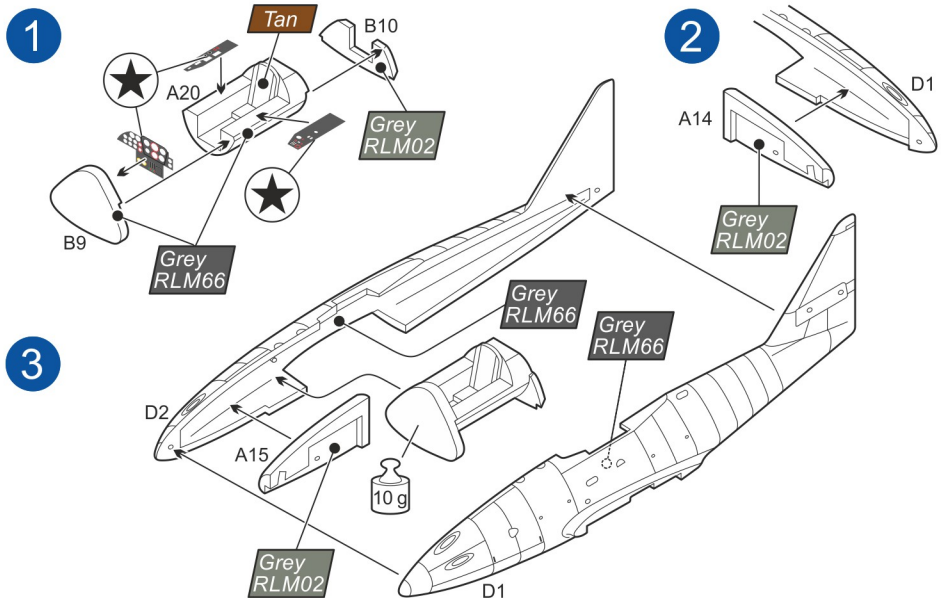

4

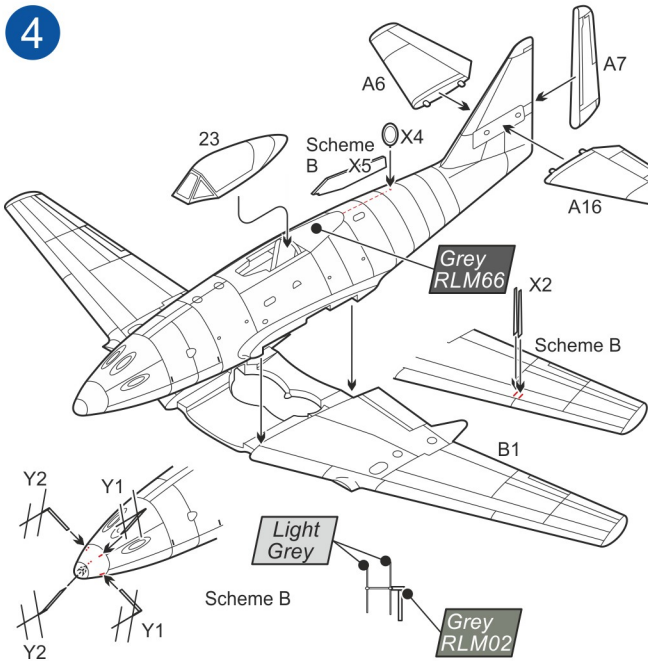

5

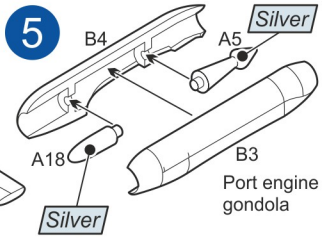

6

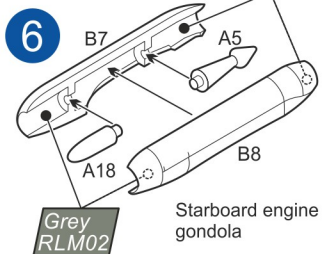

7

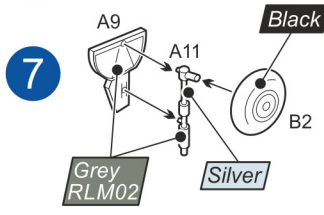

8

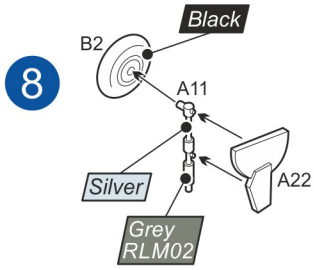

9

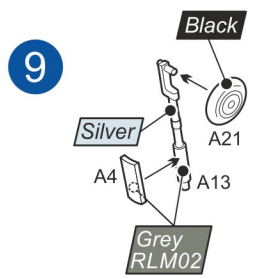

10

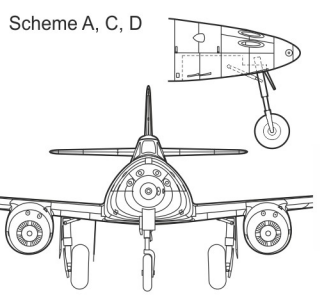
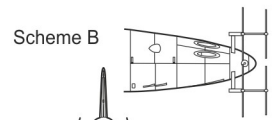
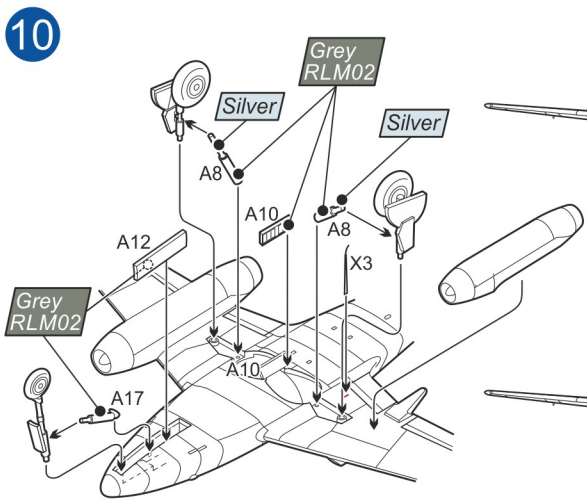

A Messerschmitt Me 262 S3, Red 3, VI+AH (W.Nr. 130008), Erprobungskommando 262 (EKdo, Operational Test Command), Luftwaffe, Lechfeld Air Base, Germany, April 1944

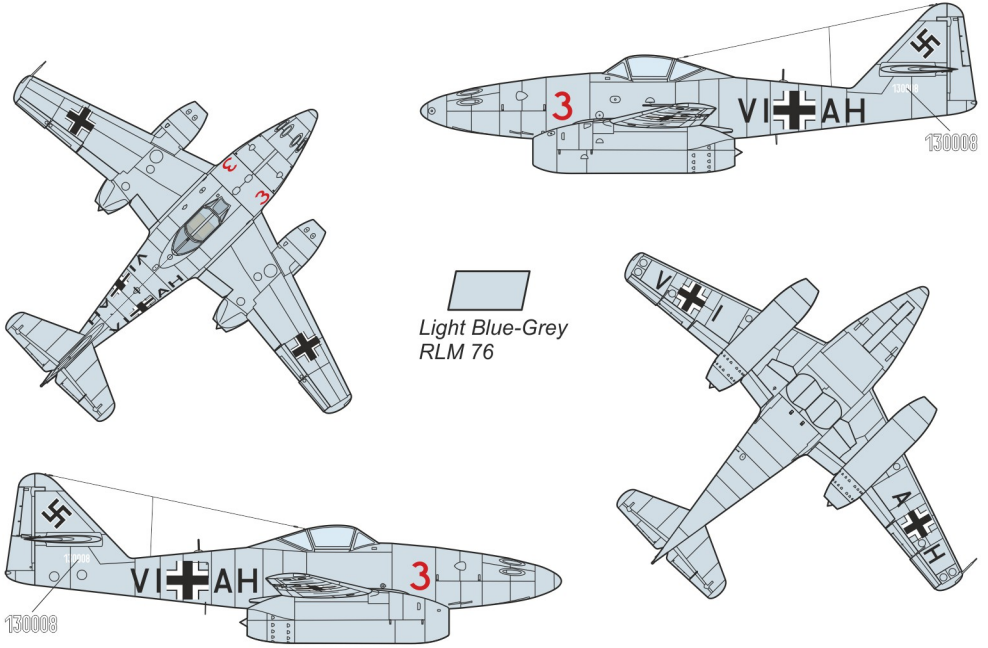

B Messerschmitt Me 262A-1a (V056), White V056 (W.Nr. 170056), FuG 226 radar antennae demonstrator, Erprobungsstelle Rechlin (E-Stelle, Weapons Testing Ground), Luftwaffe, Rechlin/Lärz Air Base, Germany, March 1945

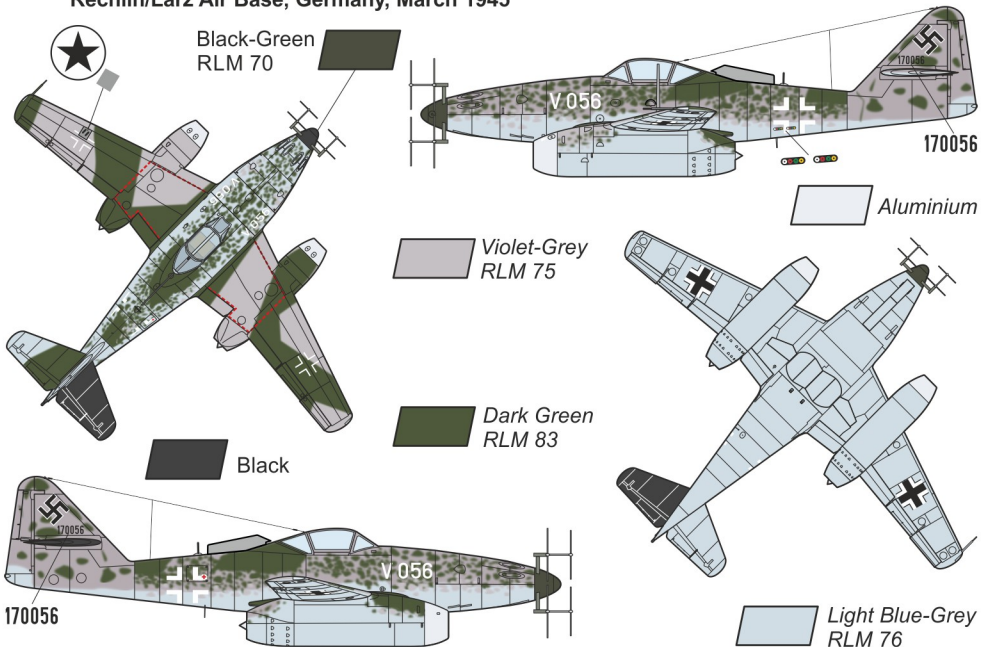

C Messerschmitt Me 262A-1a, Yellow 7 (W.Nr. 110800), 1./JG 7, Luftwaffe/RAF, Žatec/Lübeck Air Base, Bohemia-Moravia Protectorate/Germany, May 1945

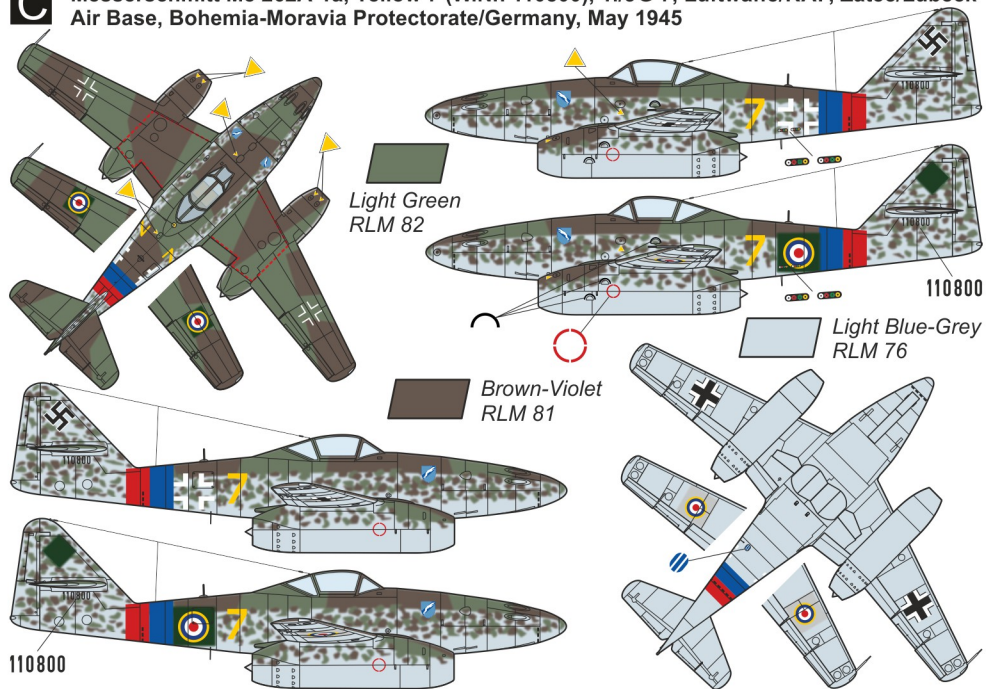

D Avia S-92 (modified Me 262A-1), Black V-36 (c/n 6), Jet Aircraft Training Flight, LVÚ Aviation Research Institute (Výcviková letka tryskových letadel při Leteckém výzkumném ústavu), Czechoslovak Air Force (vojenské letectvo ČSLA), Žatec and Prague-Kbely Air Bases, Czechoslovakia, 1949-50

