

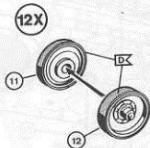

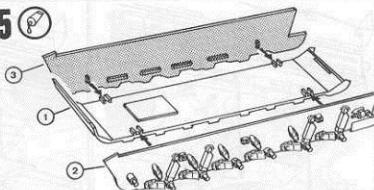

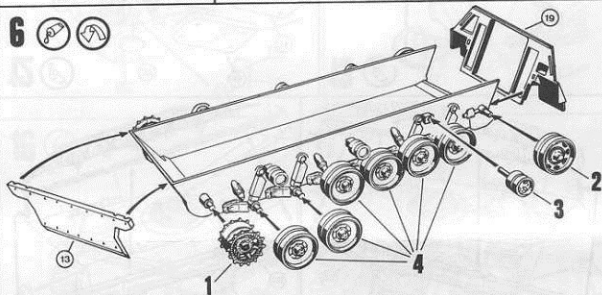

4 5 6  7  8 

9 10 11 12 13 

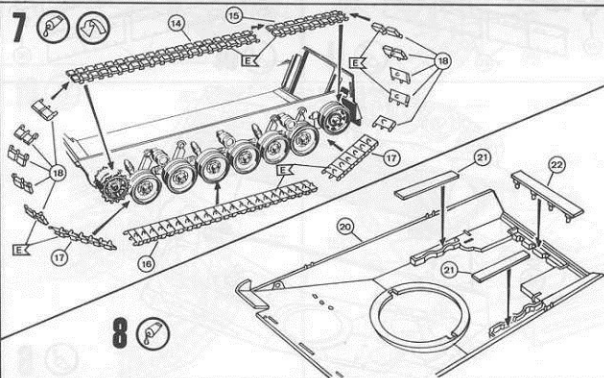
14

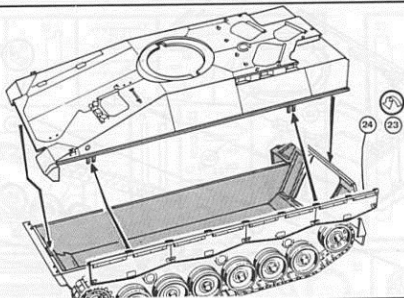
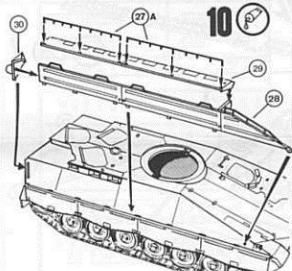

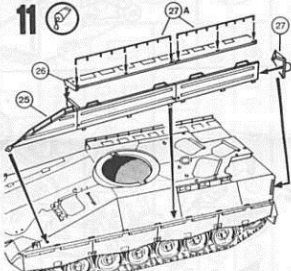
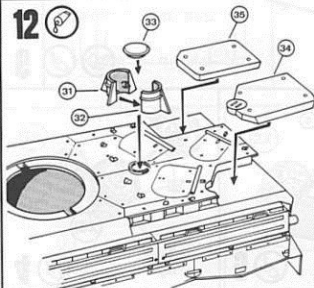
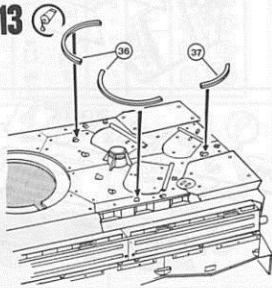
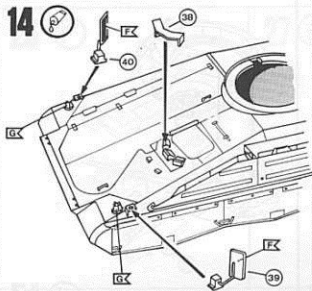
15

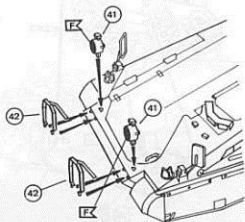

16

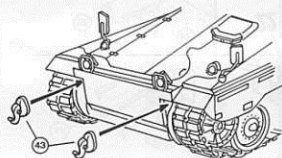

17

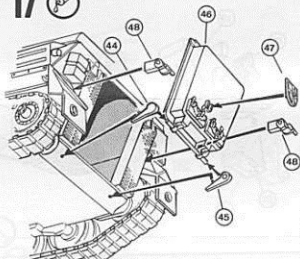

18

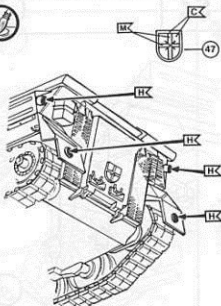

19

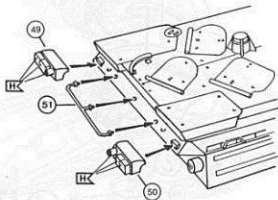

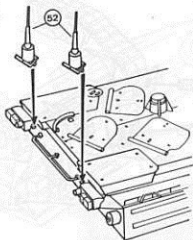
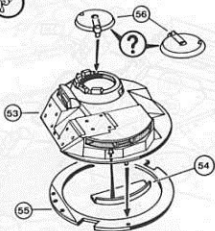
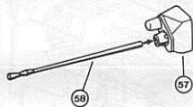
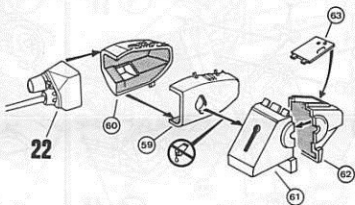
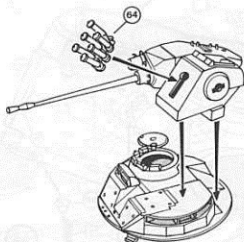
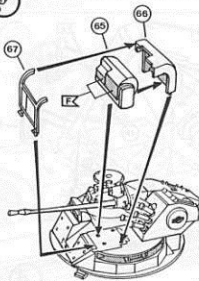
20 21 22 23 24 25 

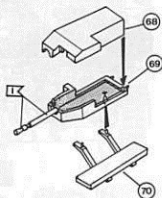
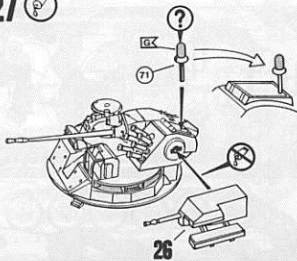
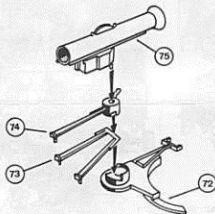
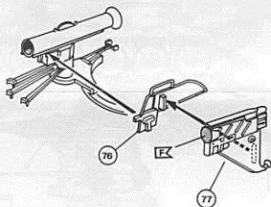
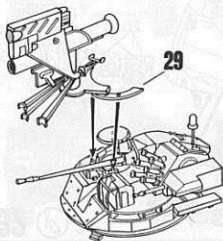
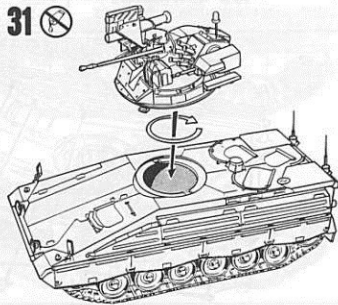
26 27 28 29 30 31 

32

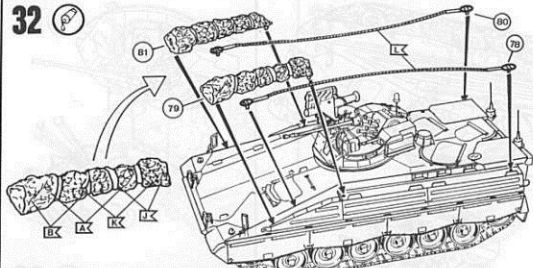

33



ES/WM	A2	ES/WM
ES/WM	ES/WM	ES/WM
●	●	●
+	+	+
SPz Marder 1 A3		
03113-0240		

5. Kompanie/PzGrenBtl. 152
Schwarzenborn, 1997

