

MARKINGS AND PAINTING

Markierungen und Bemalung
Marcio & Pittura

Decoracion et Peinture
Oznakowania i Malowanie

Decoracion y Pintura
Označeni & Zbarveni

999. Afrika-Brigade, Greece 1943

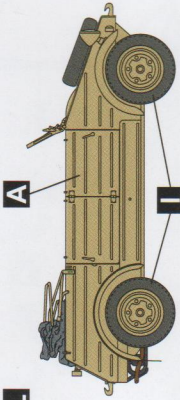
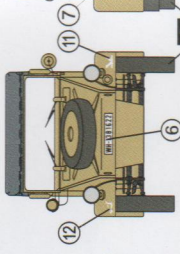
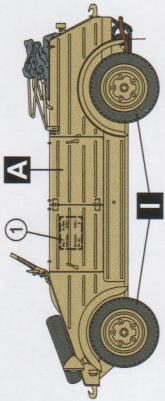

Panzer Propaganda Kompanie 697, Russia 1943.

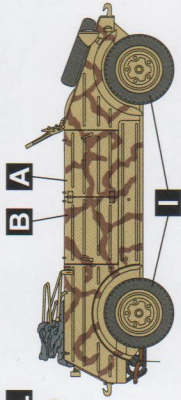
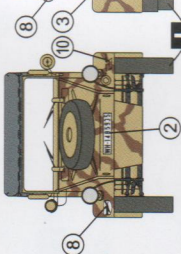
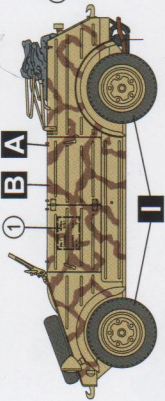

Sturmgeschütz-Brigade 667, France 1944

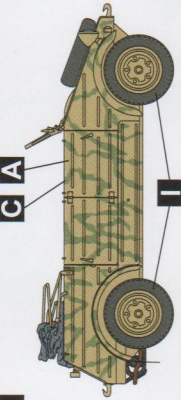
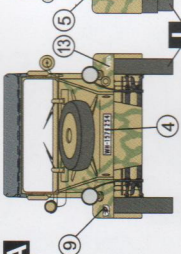
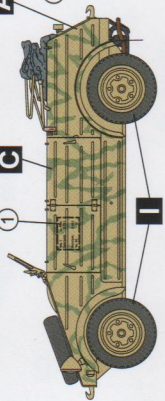

U.S. 3rd Armored Division, 83rd Recon Battalion, Germany 1945.

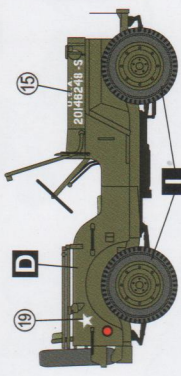
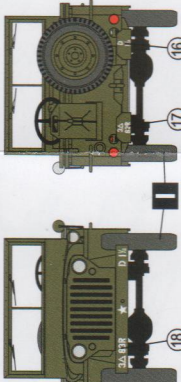
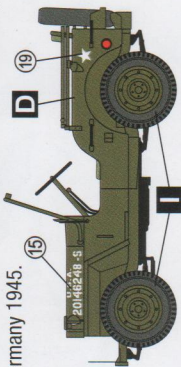

2nd Polish Korps - Military Police, Italy 1944.

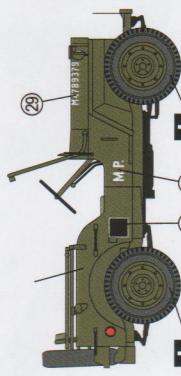
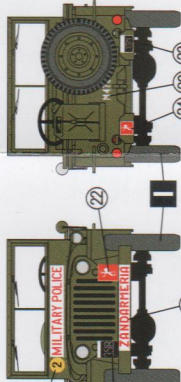
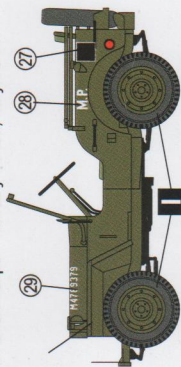

Ramcke Brigade, Tunis 1943.

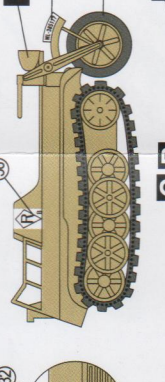
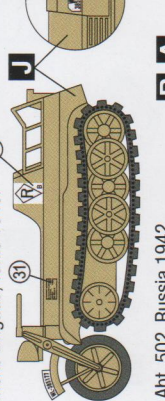

Pz.Abt. 502, Russia 1942.

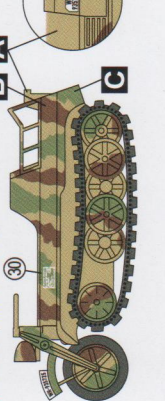

WWII Light Military Vehicles Set
72705

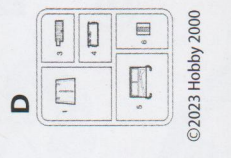
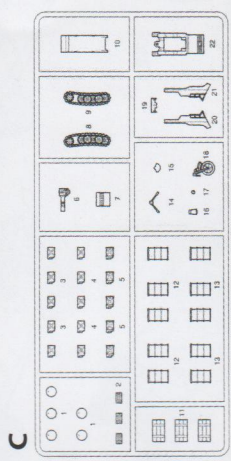
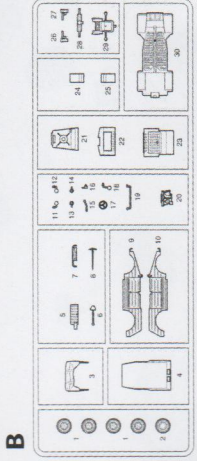
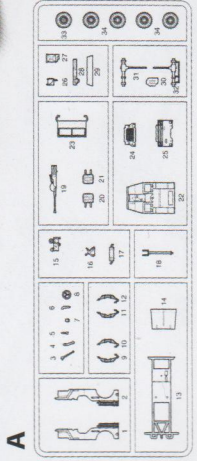

©2023 Hobby 2000

Color Chart	AK Interactive	AMMO	HATAKA	Mr. COLOR	TAMIYA
Dunkelgelb RAL 7028	RC060	010	244	039	XF-60
Rotbraun RAL 8017	RC068	016	305	041	XF-64
Olivegrün RAL 6003	RC047	001	059	070	XF-61
Olive Drab	RC026	926	018	012	XF-62
Silver	AK478	195	003	8	X-11
Gun Metal	RC015	045	106	214	X-10
Flat White	RC004	047	101	62	XF-2
Flat Black	RC001	046	100	33	XF-1
Tire Black	RC022	033	040	137	XF-85
Gelbbraun RAL 8000	RC063	013	303	044	
Khaki	RC033	113	064	055	XF-51
Field Gray	RC048	F514	151	052	XF-53
Wood	AK11351	036	131	043	XF-78
Dunkelgrau RAL 7021	RC057	008	224	513	XF-63
Rust	AK11103	042	131		XF-68
Steel	AK476	191		C028	XF-56

ASSEMBLY INSTRUCTION

Bauanleitung
Instrucciones de Montaje
Istruzioni di Assemblaggio
Montážní Instrukce

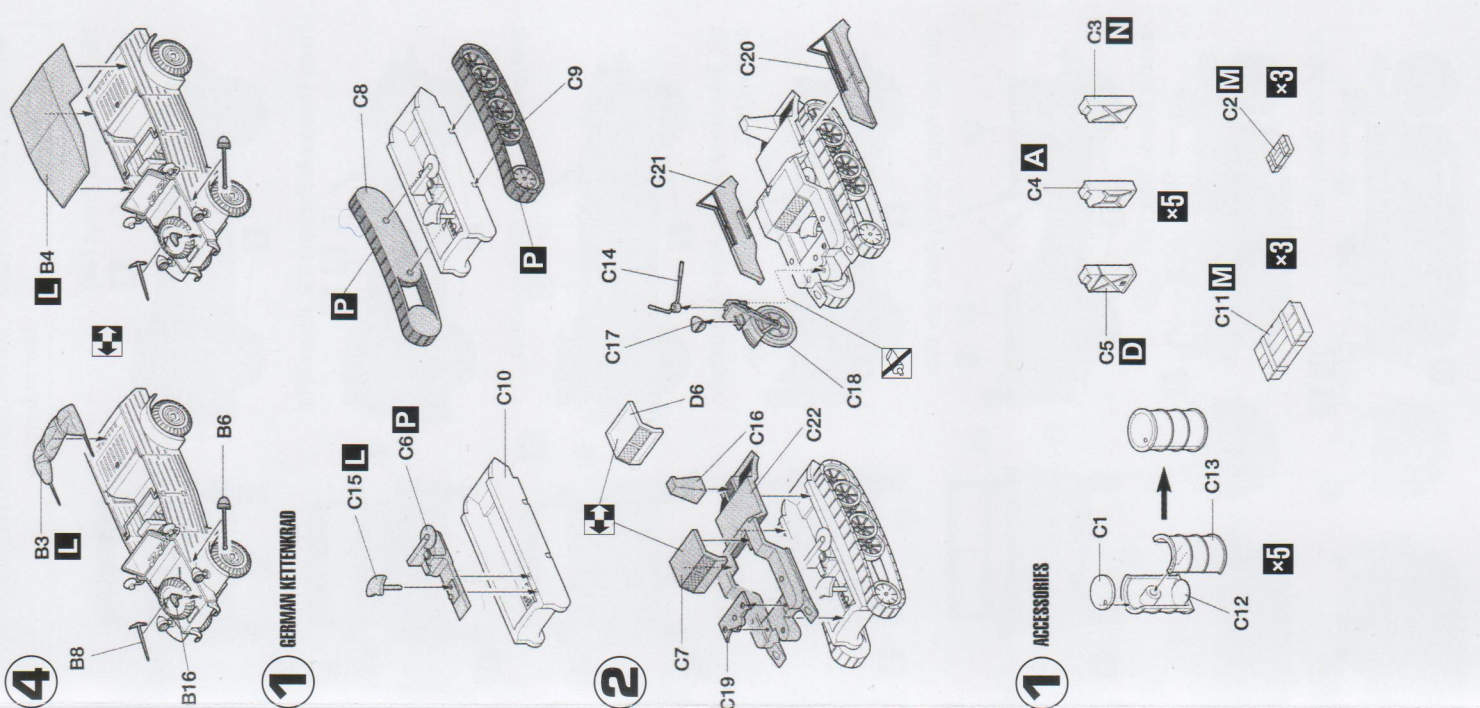
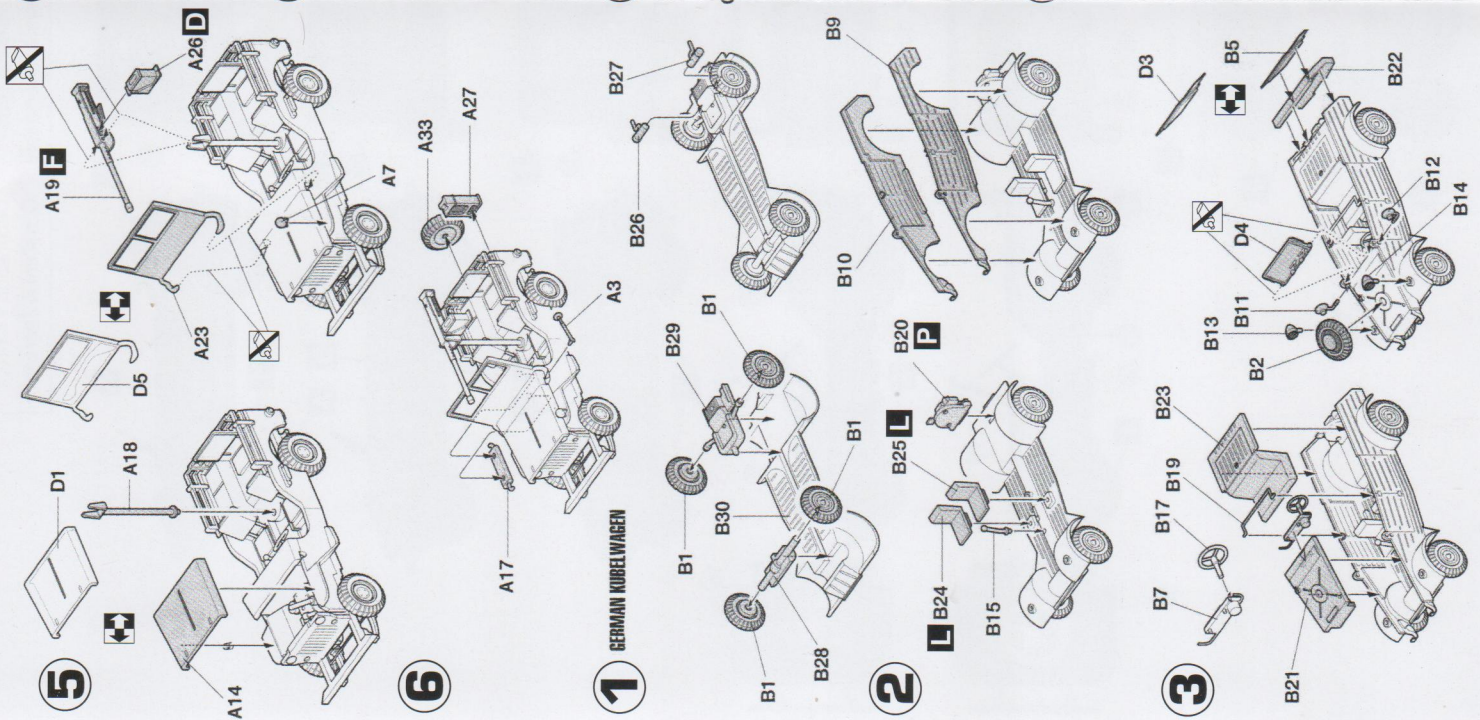
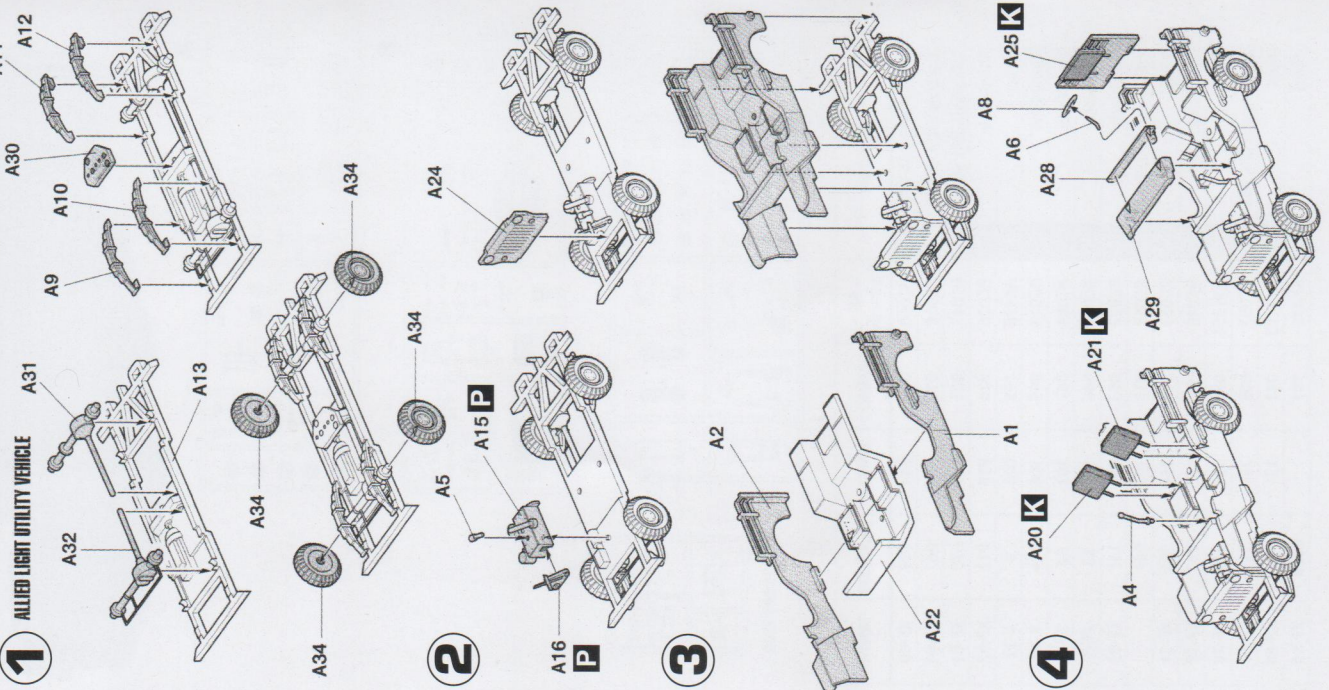

1 ACCESSORIES