

# F-14

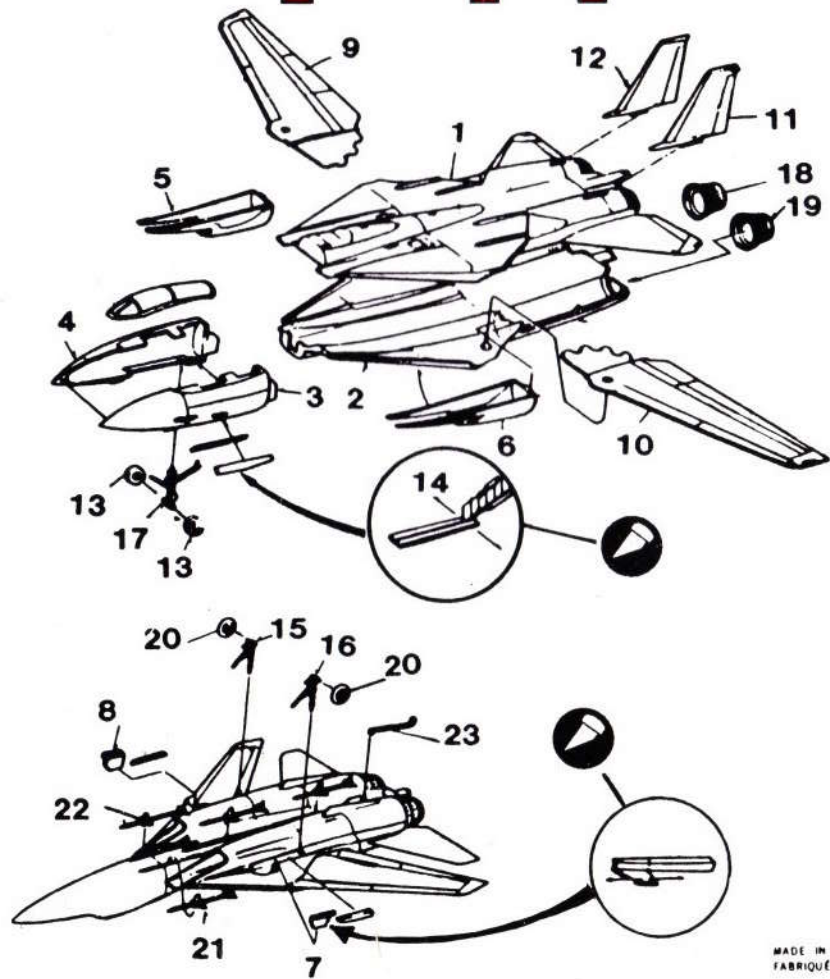

# F-18

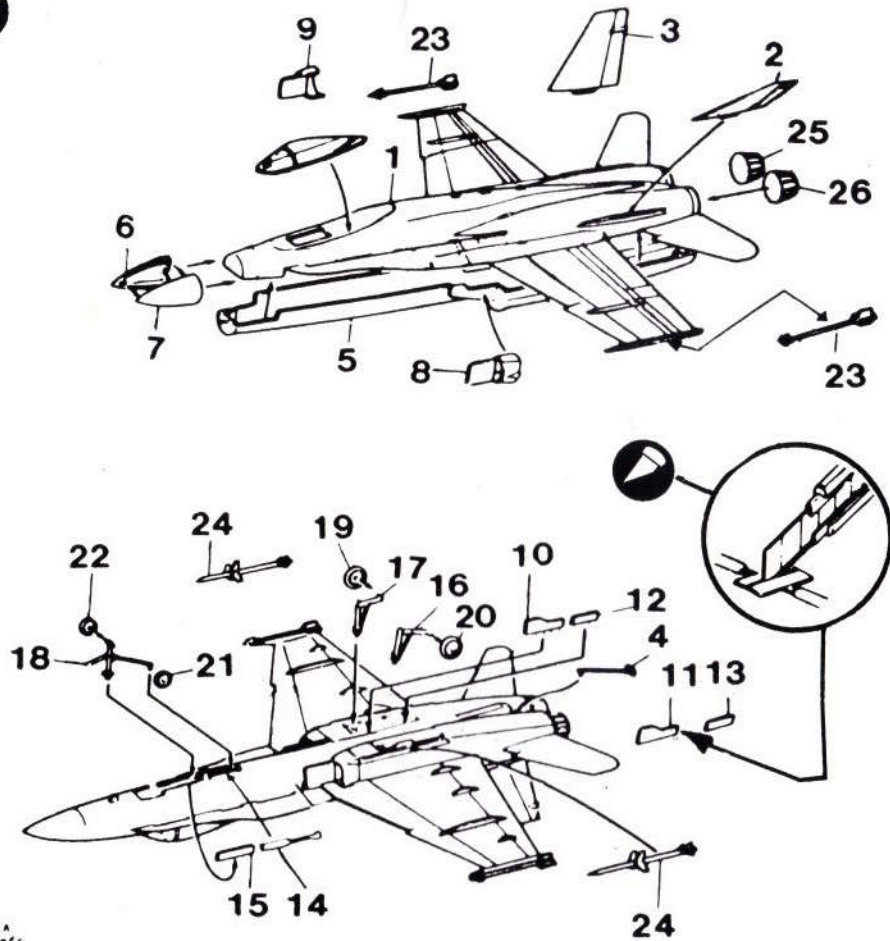

I

II

III

FS 36375

FS 36622

FS 30400

FS 36320

FS 35237

FS 30104

FS 34079

Metal

FS 33613

Metal

### III F-14, Islamic Republic of Iran

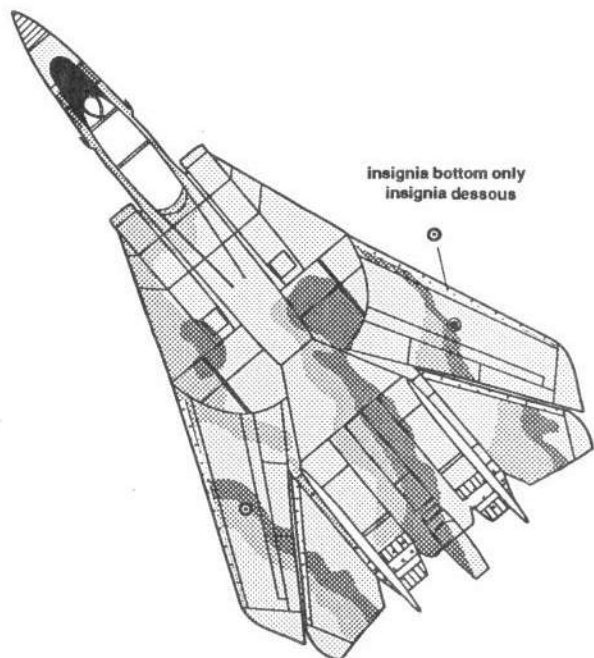
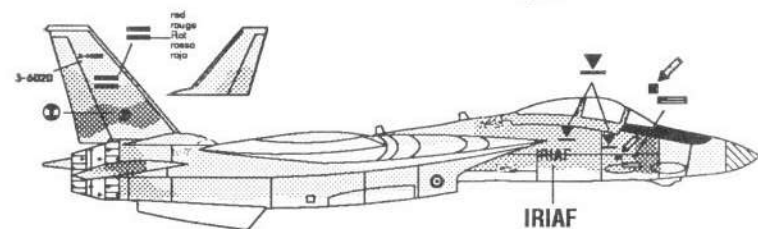
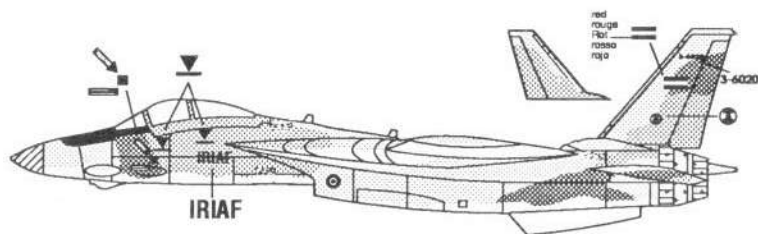

# F-14

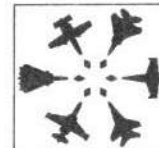

## PERSIAN GULF FIGHTERS!

HC1002 • 1:144 • Tomcat Fighter

#### BRITAIN

"CAUTION: NOT SUITABLE FOR CHILDREN UNDER 3 YEARS. CONTAINS SMALL PARTS."

#### FRANCE

CERTAINS PRODUITE CONTIENNENT DES PIÈCES DE PETITE DIMENSION QUI NE CONVIENT PAS A UN ENFANT DE MOINS DE 36 MOIS.

#### GERMANY

VORSICHT: NICHT FÜR KINDER UNTER 36 MONATEN-ERTHÄLT KLEINE TEILE.

#### ITALY

PRODOTTO NON ADATTO AI BAMBINI DI ETA INFERIORE AI 36 MESI. CONTIENE PICCOLLO OGGETTI.

#### HOLLAND

KAN GEVAAR OPLEVEREN VOOR KINDEREN TOT 3 JAAR. BEVAT KLEINE ONDERDELEN.

#### PORTUGAL

ATENCAO: IMPRÓPRIO PARA CRIANÇAS COM MENOS DE 3 ANOS. CONTÉM PEÇAS PEQUENAS.

#### SPAIN

ATENCIÓN: NO ES CONVENIENTE PARA NIÑOS MENORES DE 3 AÑOS. CONTIENE PIEZAS PEQUEÑAS.

#### DENMARK

FORSIGTIGI IKKE EGNET TIL BORN UNER 3 AR. INDEHOLDER SMA DELE.

#### GREECE

ΠΡΟΣΟΧΗ: ΔΕΝ ΕΙΝΑΙ ΚΑΤΑΛΛΗΛΟ ΓΙΑ ΠΑΙΔΙΑ ΚΑΤΩ ΤΩΝ ΤΡΙΩΝ ΕΤΩΝ ΠΕΡΙΕΧΕΙ ΜΙΚΡΑ ΤΕΜΑΧΙΑ.





- Read This Before You Begin!**
- study the assembly drawings
  - each plastic part is identified by number
  - check the fit of each piece before cementing
  - do not use too much cement to join parts
  - model may be painted to match box illustration

- Lisez Ce Qui Suit Avant De Commencer Le Montage!**
- etudier les schémas d'assemblage
  - chaque pièce plastique porte un numéro d'identification
  - contrôler que chaque pièce soit bien conforme avant de la coller à sa place
  - utilisez uniquement une colle spéciale pour polystyrène
  - le modèle peut être peint conformément aux illustrations de la boîte

- Vor Zusammenbau lesen sie bitte!**
- studiere die Bauanleitung
  - die Plastikteile sind gekennzeichnet durch ihre Nummern
  - vor dem Kleben prüfe ob die Teile zusammenpassen können
  - benutze nicht zuviel Klebstoff
  - die Bemalung des Modells kann auf dem Beckelbild zeigen

## Colors & Markings • Appliques et Couleurs



### I F-14, VF-14, USS John F. Kennedy, 1990

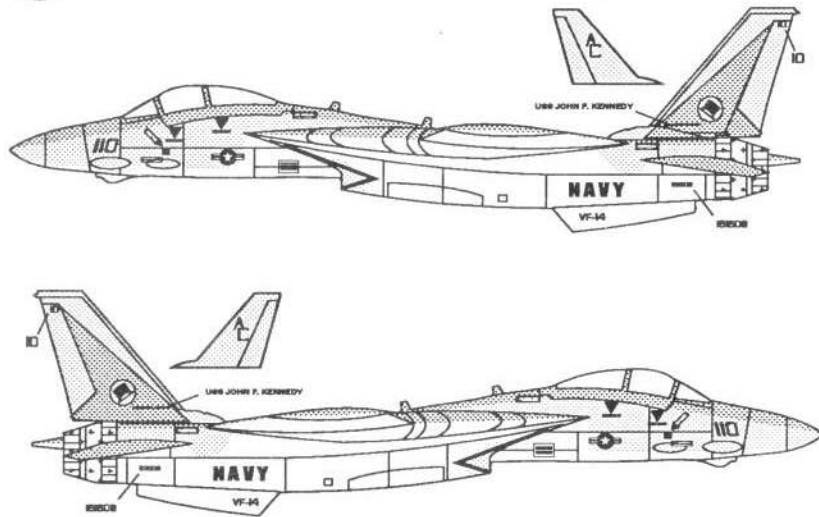

### II F-14, VF-103, USS Saratoga, 1990

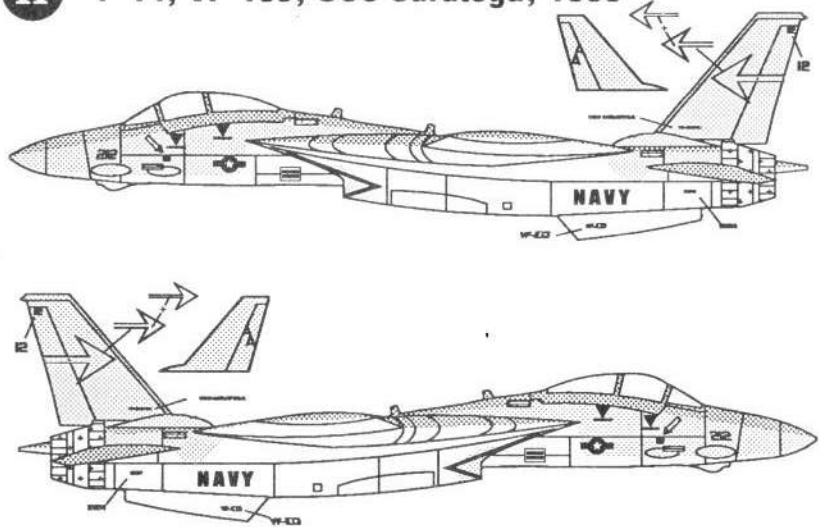

I

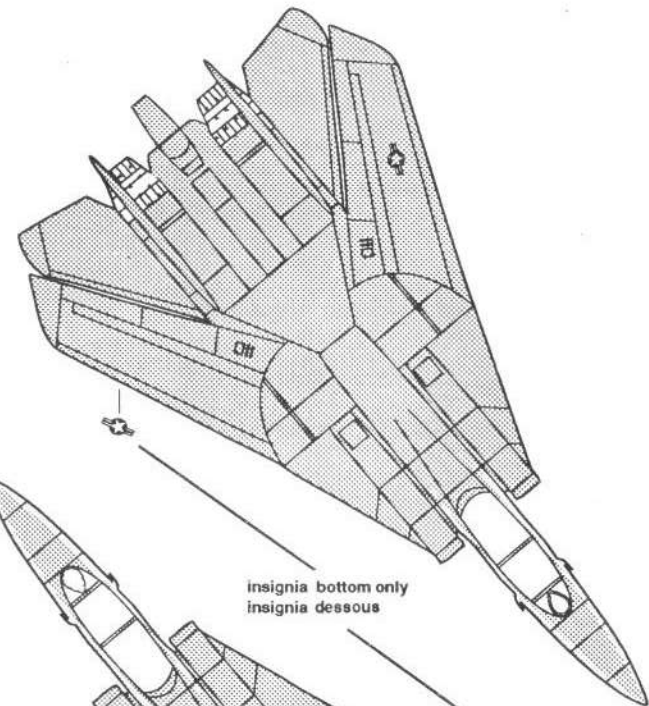

II

insignia bottom only  
insignia dessous

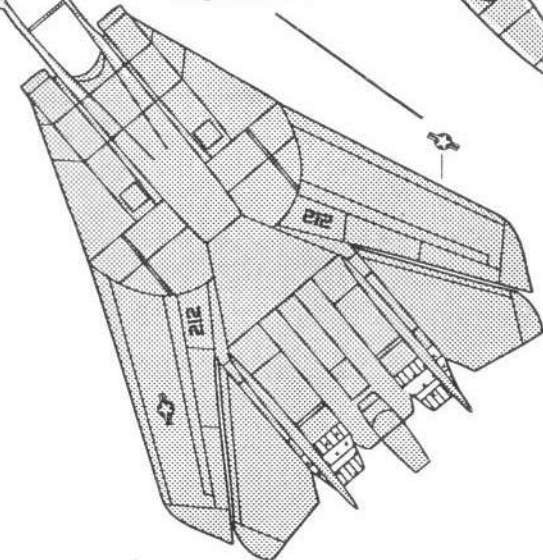

I II III

FS 36375 FS 36320 FS 35237  
 FS 36118 FS 33613 Metal

III F-18, VFA-136, USS Dwight D. Eisenhower, 1990

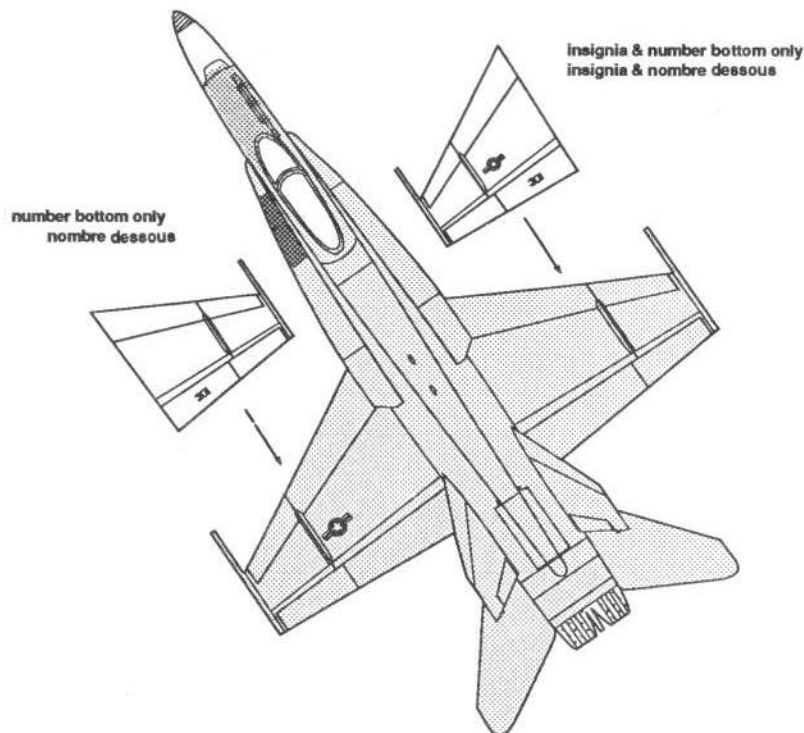
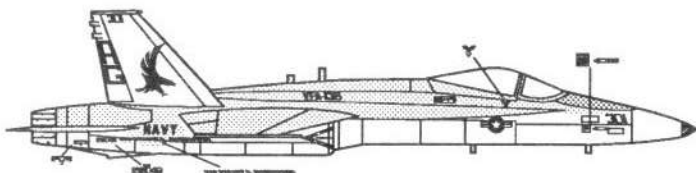
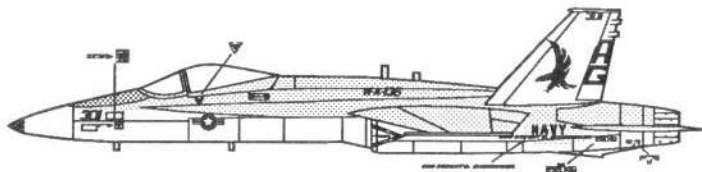

F-18



HC1003 • 1:144 • Hornet Fighter

**BRITAIN**

"CAUTION: NOT SUITABLE FOR CHILDREN UNDER 3 YEARS. CONTAINS SMALL PARTS."

**FRANCE**

CERTAINS PRODUITE CONTIENNENT DES PIÈCES DE PETITE DIMENSION QUI NE CONVIENT PAS A UN ENFANT DE MOINS DE 36 MOIS.

**GERMANY**

VORSICHT: NICHT FÜR KINDER UNTER 36 MONATEN- ERTHÄLT KLEINE TEILE.

**ITALY**

PRODOTTO NON ADATTO AI BAMBINI DI ETA INFERIORE AI 36 MESI. CONTIENE PICOLLO OGGETTI.

**HOLLAND**

KAN GEVAAR OPLEVEREN VOOR KINDEREN TOT 3 JAAR. BEVAT KLEINE ONDERDELEN.

**PORTUGAL**

ATENCAO: IMPRÓPRIO PARA CRIANÇAS COM MENOS DE 3 ANOS. CONTÉM PEÇAS PEQUENAS.

**SPAIN**

ATENCION: NO ES CONVENIENTE PARA NINOS MENORES DE 3 ANOS. CONTIENE PIEZAS PEQUENAS.

**DENMARK**

FORSIGTIGI IKKE EGNET TIL BORN UNER 3 AR. INDEHOLDER SMA DELE.

**GREECE**

ΠΡΟΣΟΧΗ: ΔΕΝ ΕΙΝΑΙ ΚΑΤΑΛΛΗΛΟ ΓΙΑ ΠΑΙΔΙΑ ΚΑΤΩ ΤΩΝ ΤΡΙΩΝ ΕΤΩΝ ΠΕΡΙΕΧΕΙ ΜΙΚΡΑ ΤΕΜΑΧΙΑ.







**Read This Before You Begin!**

- study the assembly drawings
- each plastic part is identified by number
- check the fit of each piece before cementing
- do not use too much cement to join parts
- model may be painted to match box illustration

**Lisez Ce Qui Suit Avant De Commencer Le Montage!**

- etudier les schémas d'assemblage
- chaque pièce plastique porte un numéro d'identification
- contrôler que chaque pièce soit bien conforme avant de la coller à sa place
- utilisez uniquement une colle spéciale pour polystyrène
- le modèle peut être peint conformément aux illustrations de la boîte

**Vor Zusammenbau lesen sie bitte!**

- studiere die Bauanleitung
- die Plastikteile sind gekennzeichnet durch ihre Nummern
- vor dem Kleben prüfe ob die Teile zusammenpassen können
- benutze nicht zuviel Klebstoff
- die Bemalung des Modells kann auf dem Becketbild zeigen

**Colors & Markings • Appliques et Couleurs**



**I F-18, USMC, VMFA-122, 1990**

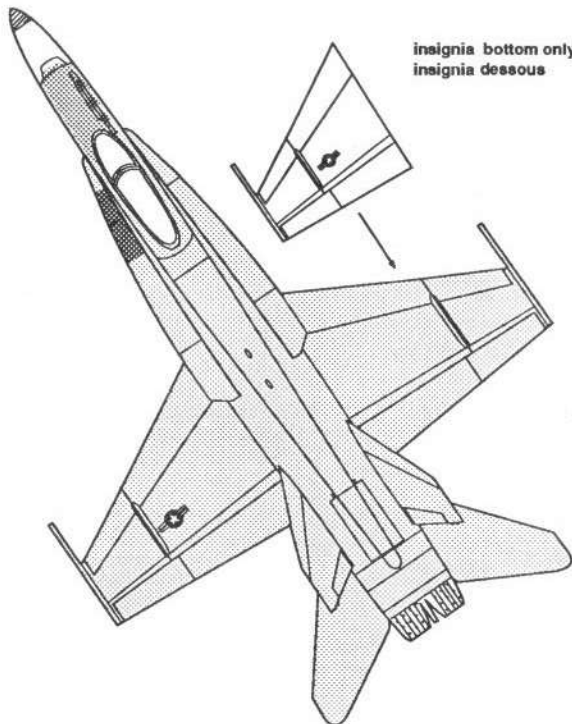
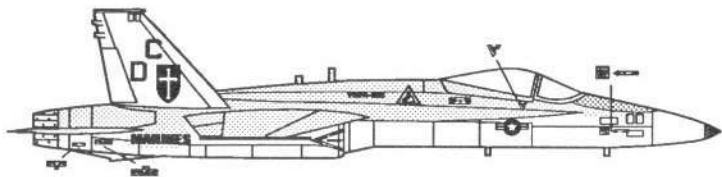
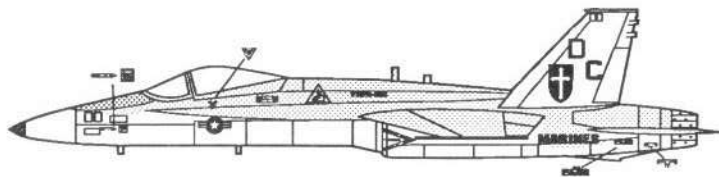

insignia bottom only  
insignia dessous

**II CF-18, CAF, 409 Sqn., 1990**

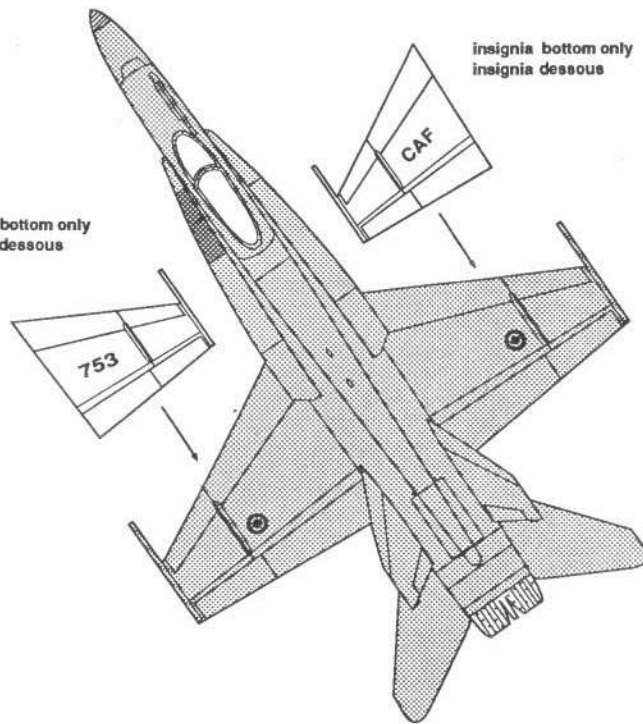
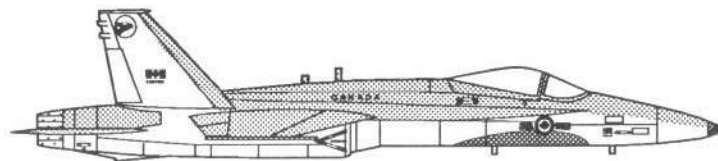
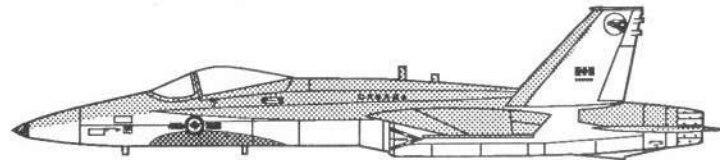

insignia bottom only  
insignia dessous

number bottom only  
nombre dessous