

SUPER44

COLORS BARVY FARBEN PEINTURE 色

GSI Creos (GUNZE)		MISSION MODELS	
AQUEOUS	Mr.COLOR	PAINTS	
[H8]	[C8]		SILVER
[H12]	[C33]	[MMP-047]	FLAT BLACK
[H52]	[C12]	[MMP-091]	OLIVE DRAB
[H53]	[C33]		NEUTRAL GRAY
[H57]	[C73]		AIRCRAFT GRAY
[H58]	[C351]	[MMP-059]	INTERIOR GREEN
[H77]	[C137]	[MMP-040]	TIRE BLACK
[H16]	[C316]	[MMP-104]	WHITE
[H324]	[C324]	[MMP-116]	LIGHT GRAY
[H327]	[C327]	[MMP-101]	RED

GSI Creos (GUNZE)		MISSION MODELS	
AQUEOUS	Mr.COLOR	PAINTS	
[H329]	[C329]	[MMP-041]	YELLOW
[H330]	[C361]	[MMP-077]	DARK GREEN
[H335]	[C363]	[MMP-094]	MEDIUM SEAGRAY
	[C352]	[MMP-067]	CHROMATE YELLOW PRIMER
	[C362]	[MMP-093]	OCEAN GRAY
Mr.METAL COLOR		METALLICS	
	[MC214]	[MMM-001]	DARK IRON
	[MC218]	[MMM-003]	ALUMINIUM
Mr.COLOR SUPER METALLIC		METALLICS	
	[SM201]	[MMC-001]	SUPER FINE SILVER 2

OPTIONAL
VOLBA

BEND
OHNOUT

SAND
BROUSIT

OPEN HOLE
VYVRTAT OTVOR

SYMMETRICAL ASSEMBLY
SYMETRICKÁ MONTÁŽ

REMOVE
ODRÍZNOUT

REVERSE SIDE
OTOČIT

APPLY EDUARD MASK
AND PAINT
POUŽIT EDUARD MASK
NABARVIT

PLASTIKOVÝ MODEL

FOTOLEPTANÉ DÍLY, EXPRESS MASK,
NEOBSAHUJE BARVY A LEPIDLO
VYROBENO V ČESKÉ REPUBLICE

POZOR! OBSAHUJE DROBNÉ A OSTRÉ DÍLY
VÝROBEK NENÍ HRAČKOU

SCALE PLASTIC KIT

PE PARTS, MASK,
PAINT AND GLUE NOT INCLUDED
MADE IN CZECH REPUBLIC

CONTAINS SMALL AND SHARP PARTS.
COLLECTORS ITEM · NOT A TOY

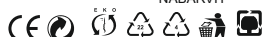

8 591437 549726

P-47D Bubbletop 1/144

Cat.No. 4464

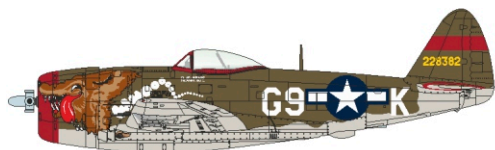

P-47D-26-RA, s/n 42-28382, flown by Lt. James R. Hopkins, 509th FS, 405th FG, 9th AF, Ophoven, Belgium, March 1945

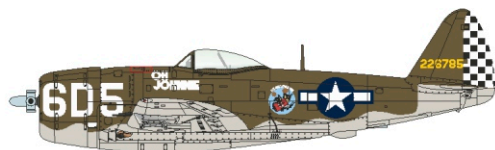

P-47D-27-RE, s/n 42-26785, flown by Lt. Raymond L. Knight, 346th FS, 350th FG, 12th AF, Pisa, Italy, 1945

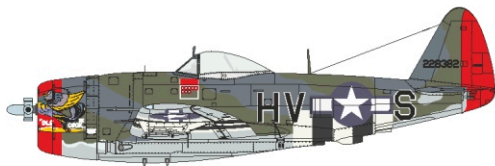

P-47D-26-RA, s/n 42-28382, flown by Capt. Donavon F. Smith, CO of 61th FS, 56th FG, 8th AF, Boxted, United Kingdom, August 1944



P-47D-30-RA, s/n 44-20866, flown by Lt. Frank J. Middleton, 65th FS, 57th FG, 12th AF, Corsica, Summer 1944

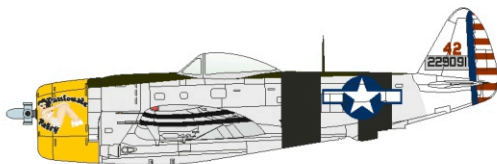

P-47D-28-RA, s/n 42-29091, flown by Lt. Ralph Barnes, 310th FS, 58th FG, 5th AF, Machinato Airfield, Okinawa, 1945

A

decal 50

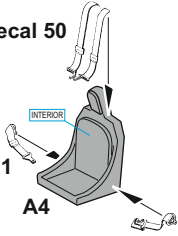

decal 51

A4

decal 52

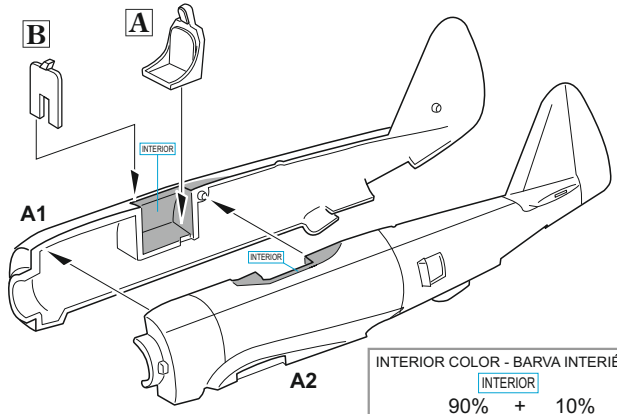
B**A**

A1

A2

INTERIOR COLOR - BARVA INTERIÉRU

INTERIOR	
90% +	10%
H12 MMP C33 047 FLAT BLACK	H12 MMP C33 047 FLAT BLACK
H53 MMP C361 059 INTERIOR GREEN	H12 MMP C33 047 FLAT BLACK

G2

H12 MMP	C33 047
FLAT BLACK	

decal 49

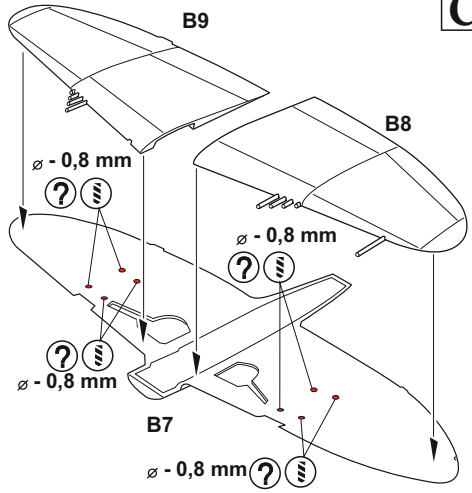
B**C****D**

B9

B8

ø - 0,8 mm

ø - 0,8 mm

ø - 0,8 mm

B7

ø - 0,8 mm

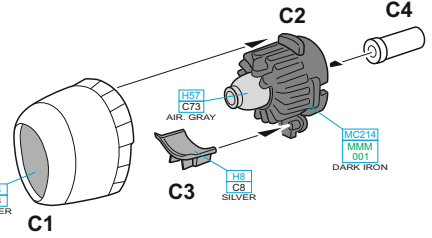

C2

C4

H57
C73
AIR. GRAYM214
MMT
091
DARK IRONH8
C8
SILVERH8
C8
SILVER

C1

C3

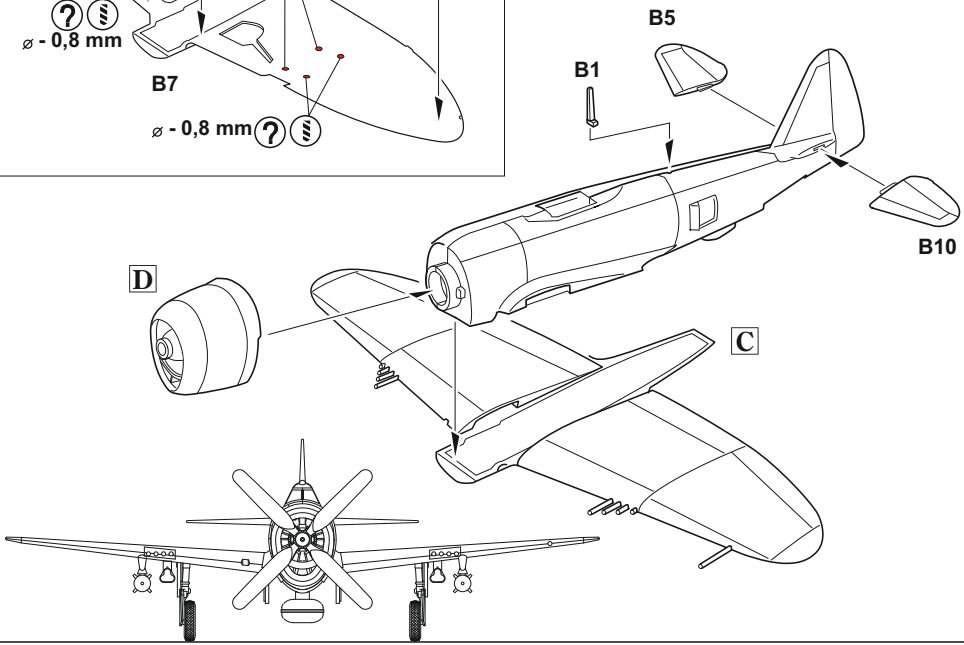
D**C**

B1

B5

B10

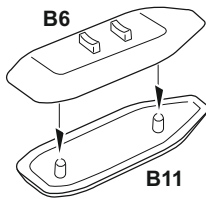
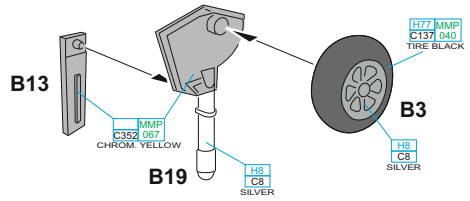
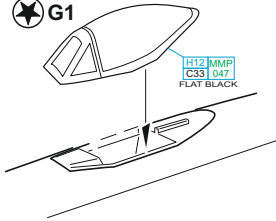
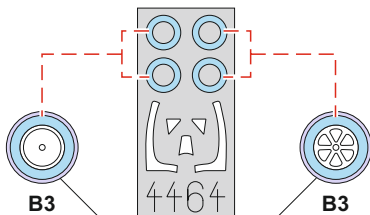
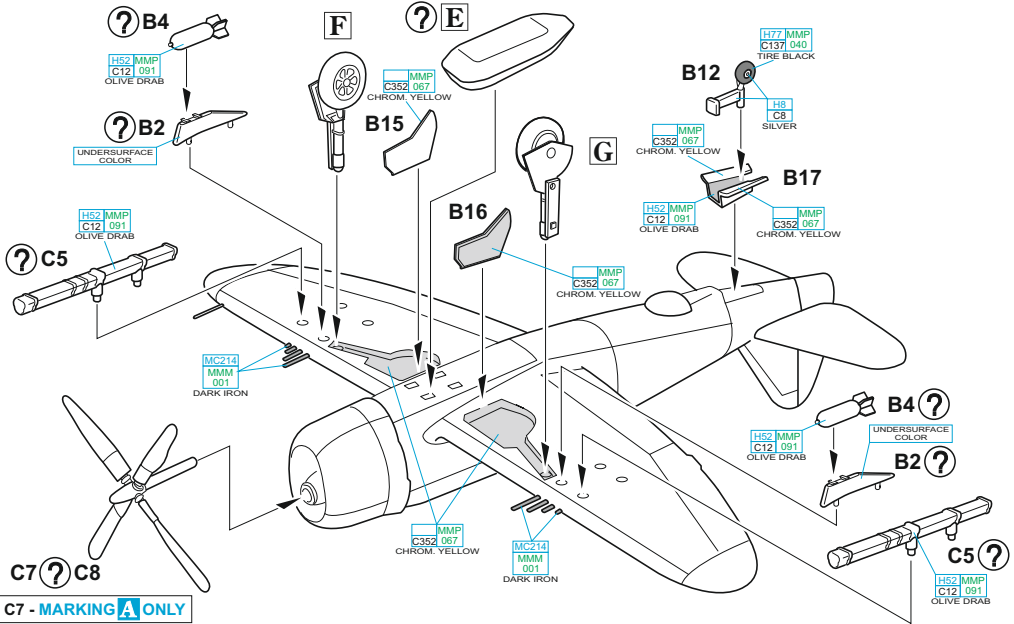
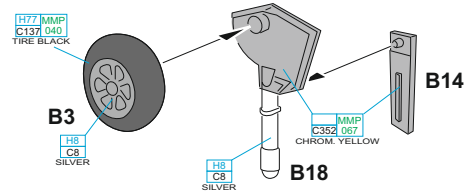
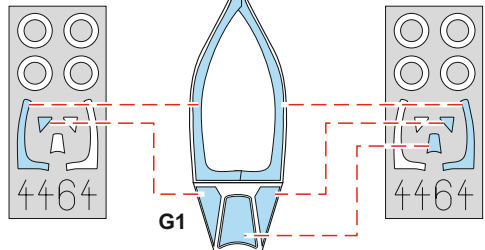
E ?**F****G1****G****LIQUID MASK**

A P-47D-26-RA, s/n 42-28382, flown by Lt. James R. Hopkins, 509th FS, 405th FG, 9th AF, Ophoven, Belgium, March 1945

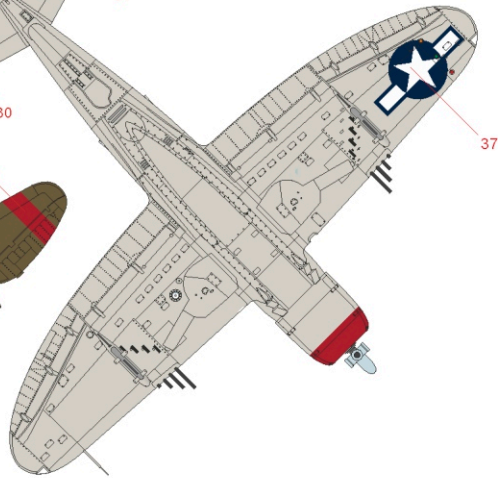
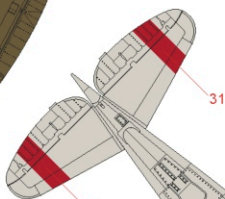
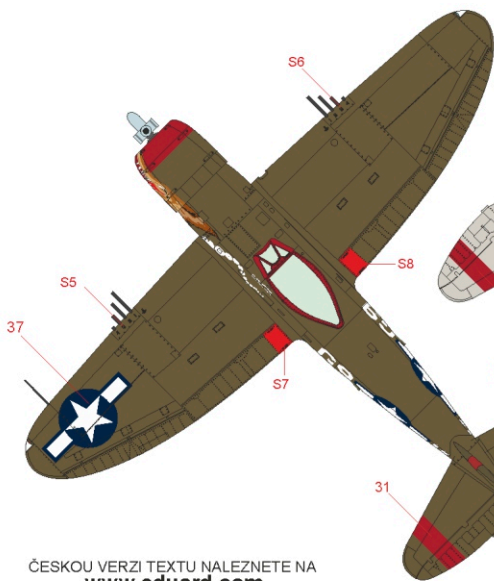
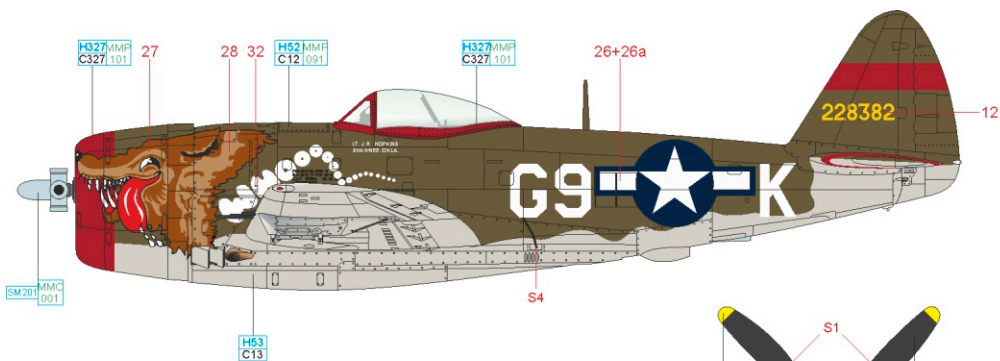

ČESKOU VERZI TEXTU NALEZNETE NA www.eduard.com
 POD KATALOGOVÝM ČÍSLEM 4464

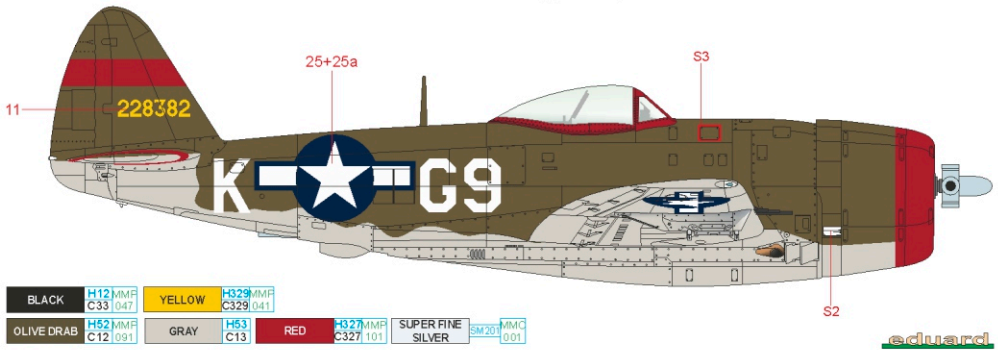

BLACK	H12 MMF C33 047	YELLOW	H329 MMF C329 041
OLIVE DRAB	H52 MMF C12 091	GRAY	H53 C13
		RED	H327 MMF C327 101
		SUPER FINE SILVER	SM201 MMG 001

B P-47D-27-RE, s/n 42-26785, flown by Lt. Raymond L. Knight, 346th FS, 350th FG, 12th AF, Pisa, Italy, 1945

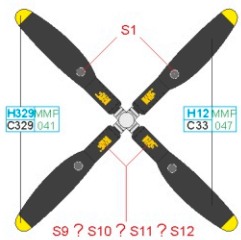
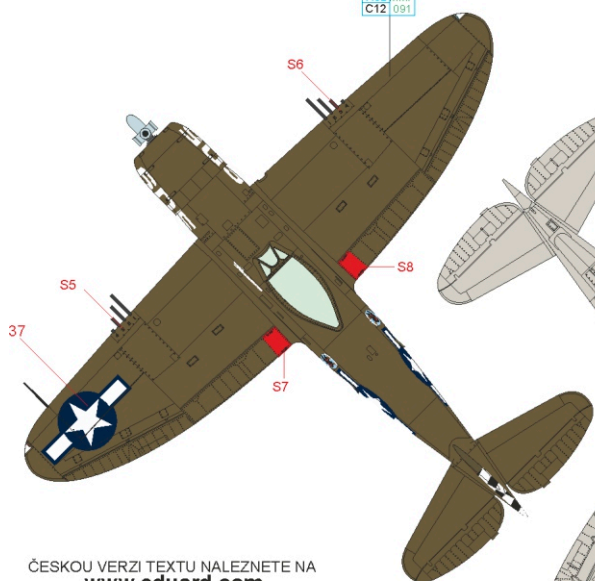
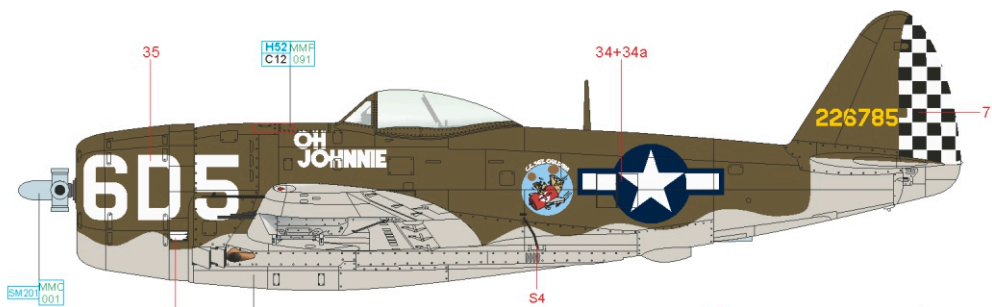

ČESKOU VERZI TEXTU NALEZNETE NA
www.eduard.com
 POD KATALOGOVÝM ČÍSLEM 4464

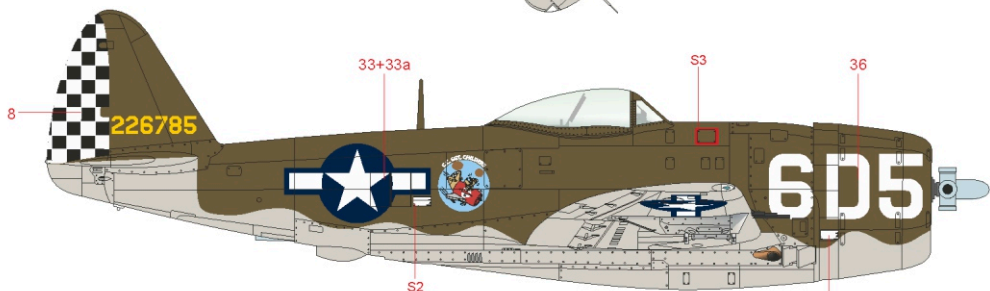

BLACK	H12 MMP C33 047	YELLOW	H329 MMP C329 041
OLIVE DRAB	H52 MMP C12 091	GRAY	H53 C13
		SUPER FINE SILVER	SM 201 MMC 001

C P-47D-26-RA, s/n 42-28382, flown by Capt. Donavon F. Smith, CO of 61th FS, 56th FG, 8th AF, Boxted, United Kingdom, August 1944

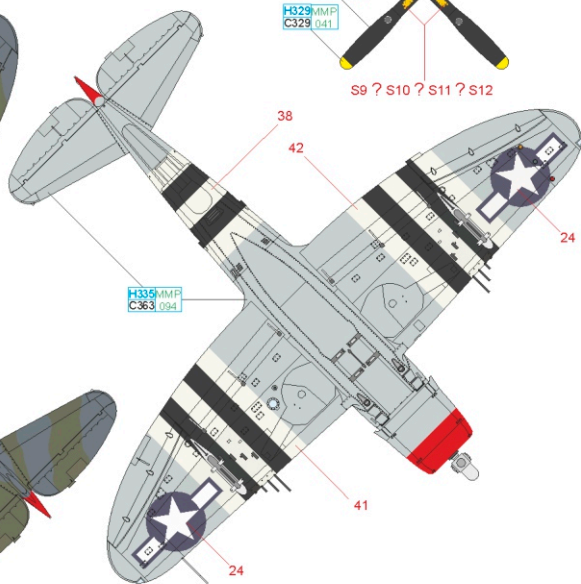
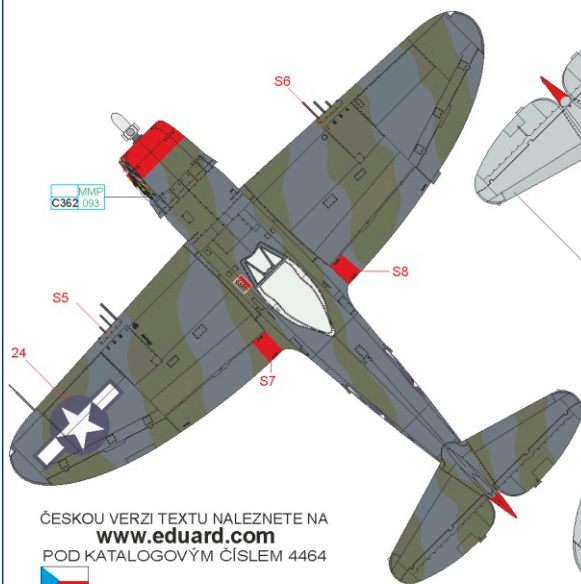
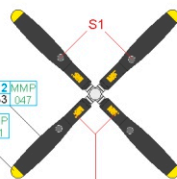
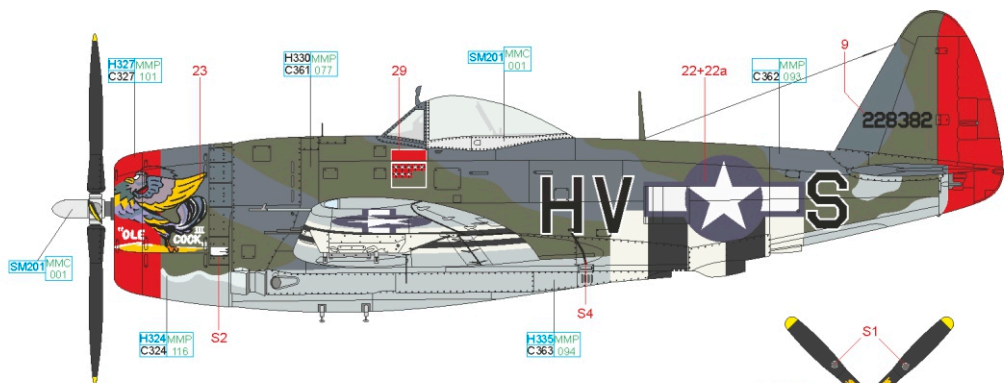

ČESKOU VERZI TEXTU NALEZNETE NA
www.eduard.com

POD KATALOGOVÝM ČÍSLEM 4464

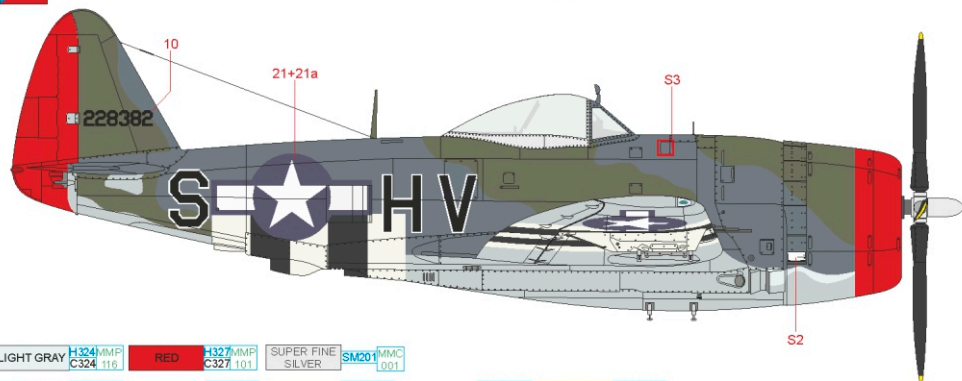

LIGHT GRAY	H324/MMP C324 116	RED	H327/MMP C327 101	SUPER FINE SILVER	SM201/MMC 001	
MEDIUM SEA GRAY	H335/MMP C363 094	OCEAN GRAY	MMP C362 093	DARK GREEN	H330/MMP C361 077	
				BLACK	H12/MMP C33 047	
					YELLOW	H329/MMP C329 041

D P-47D-30-RA, s/n 44-20866, flown by Lt. Frank J. Middleton, 65th FS, 57th FG, 12th AF, Corsica, Summer 1944

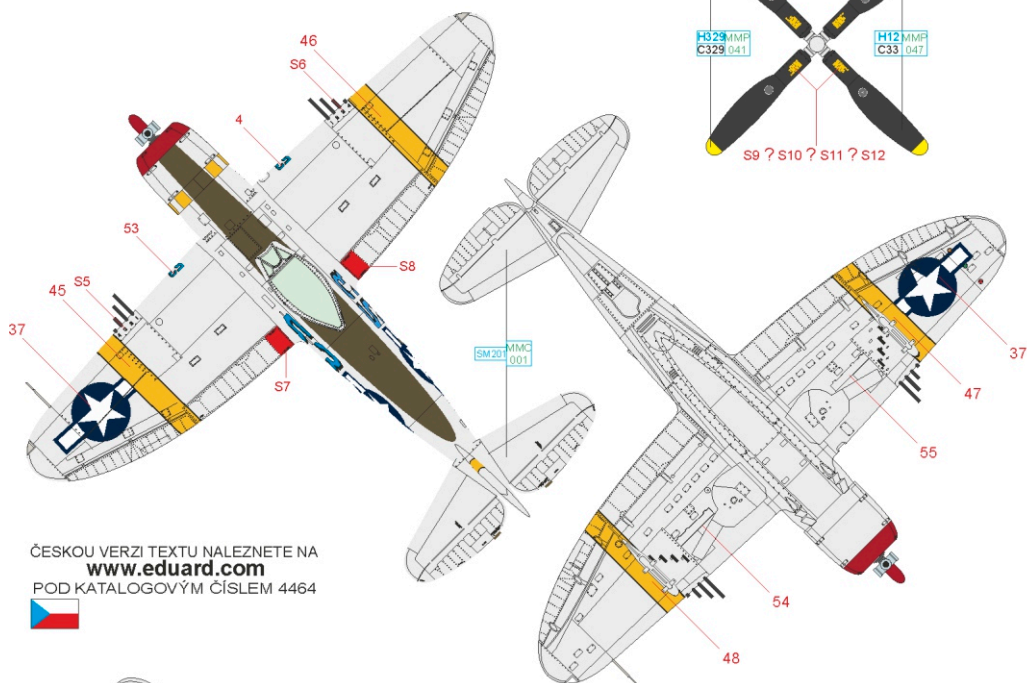
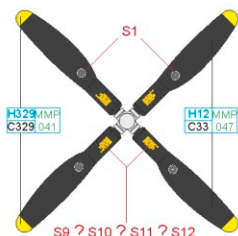
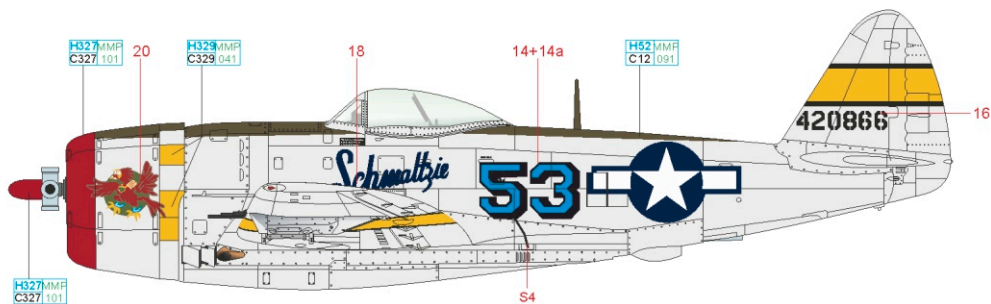

ČESKOU VERZI TEXTU NALEZNETE NA
www.eduard.com
 POD KATALOGOVÝM ČÍSLEM 4464

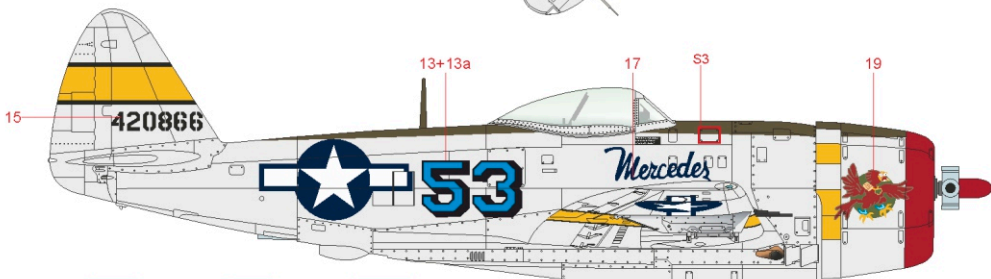

BLACK	H12/MMF C33 047	YELLOW	H329/MMF C329 041	RED	H327/MMF C327 101
OLIVE DRAB	H52/MMF C12 091	GRAY	H53 C13	SUPER FINE SILVER	SM20/MMC 001

E P-47D-28-RA, s/n 42-29091, flown by Lt. Ralph Barnes, 310th FS, 58th FG, 5th AF, Machinato Airfield, Okinawa, 1945

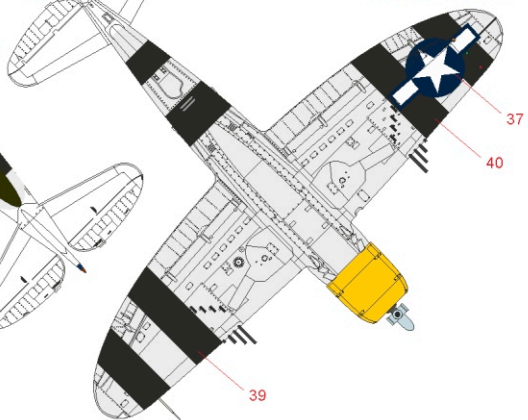
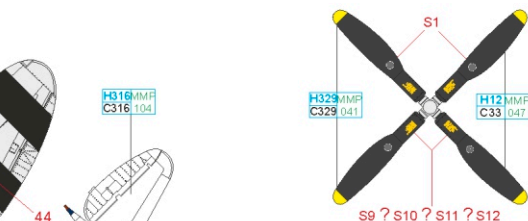
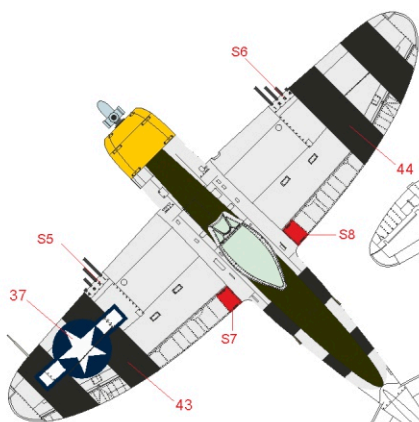
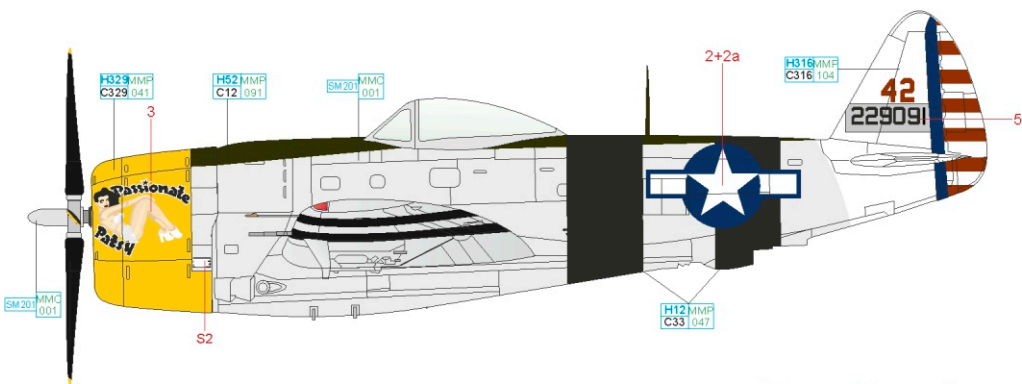

ČESKOU VERZI TEXTU NALEZNETE NA
www.eduard.com
 POD KATALOGOVÝM ČÍSLEM 4464

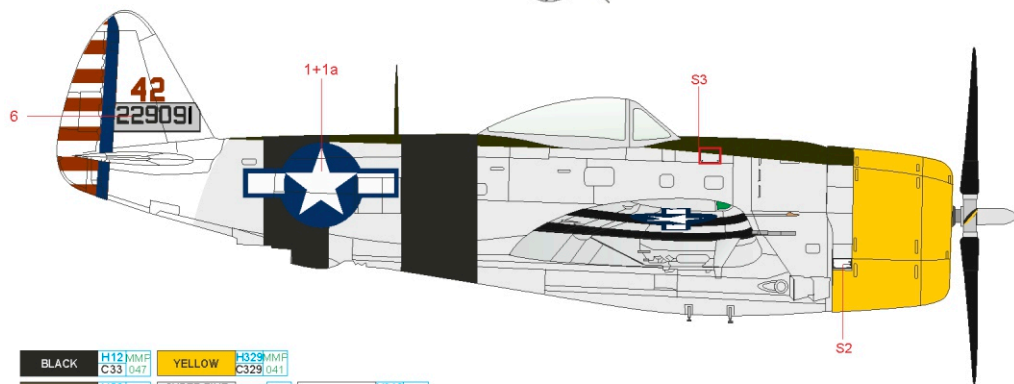

BLACK	H12/MMP C33 047	YELLOW	H329/MMP C329 041
OLIVE DRAB	H52/MMP C12 091	SUPER FINE SILVER	SM201/MMP 001
		WHITE	H316/MMP C316 104