

**1** Bf 109G-4, flown by Oberleut. Wolfgang Tonne, Staffelführer 3./JG.53, february 1943.

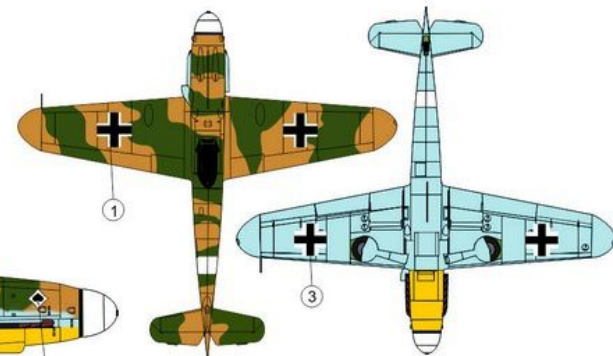

**2** Bf 109G-4, flown by Fw. Hans Waldmann, 6./JG.52, Anapa airfield, Russia, june 1943.

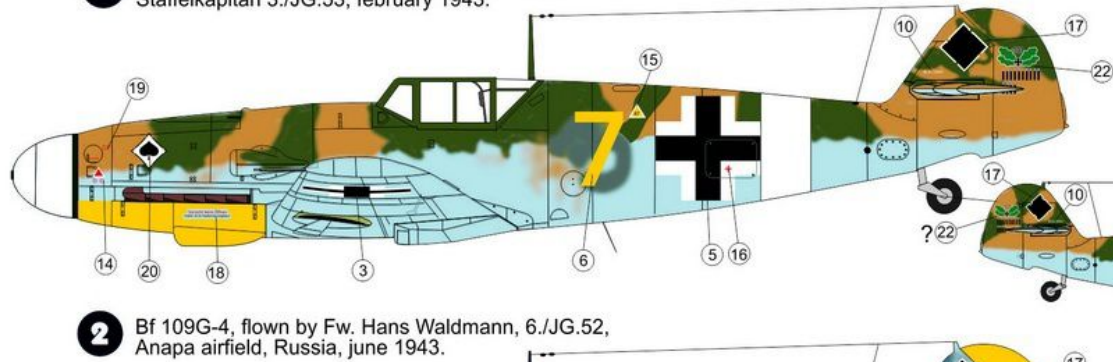
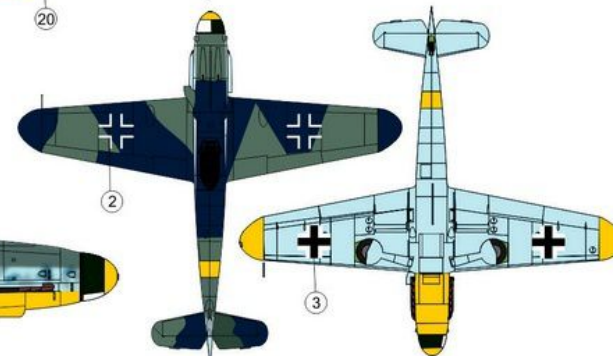
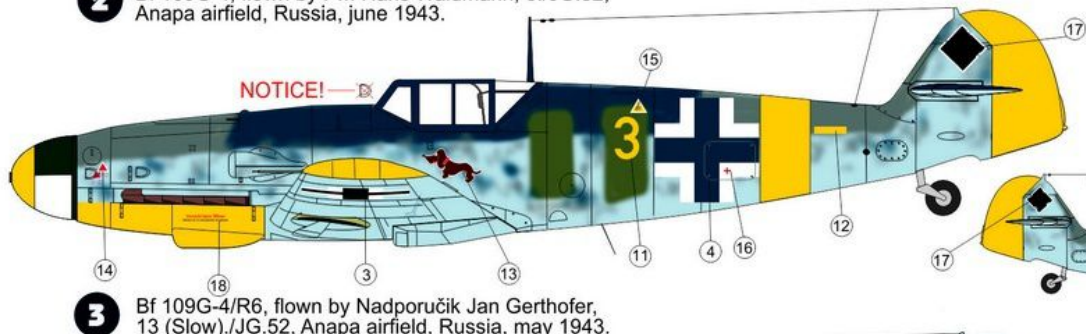

**3** Bf 109G-4/R6, flown by Nadporučik Jan Gerthofer, 13 (Slow)/JG.52, Anapa airfield, Russia, may 1943.

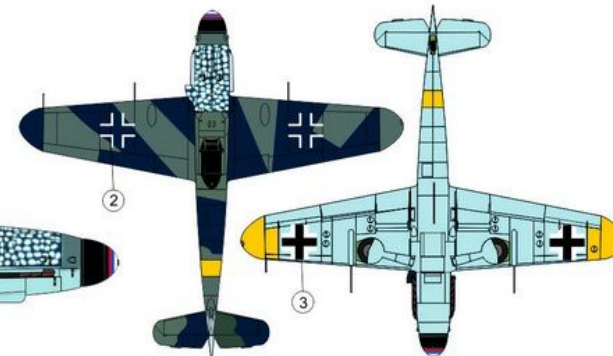
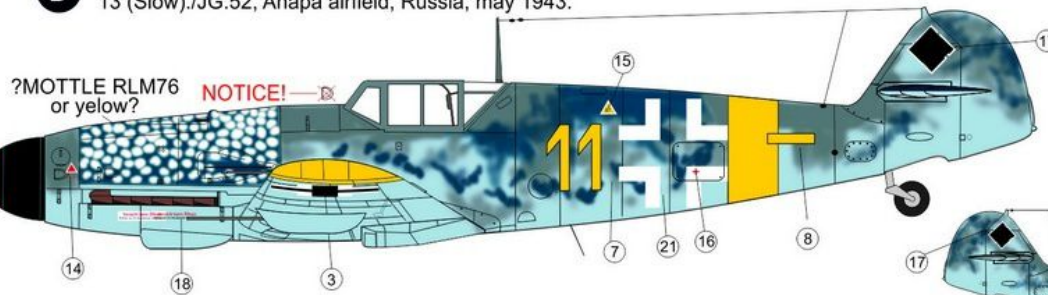

**4** Bf 109G-4/, flown by Rotnik Jan Režňák, 13 (Slow)/JG.52, Anapa airfield, Russia, may 1943.

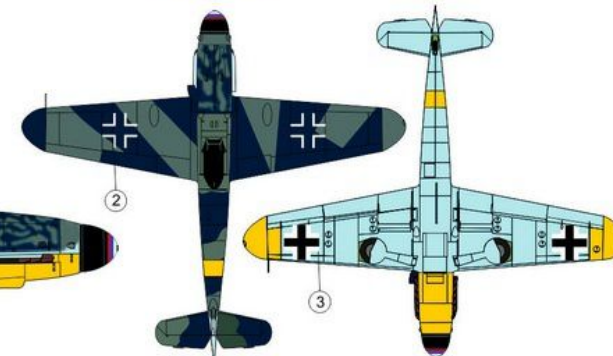
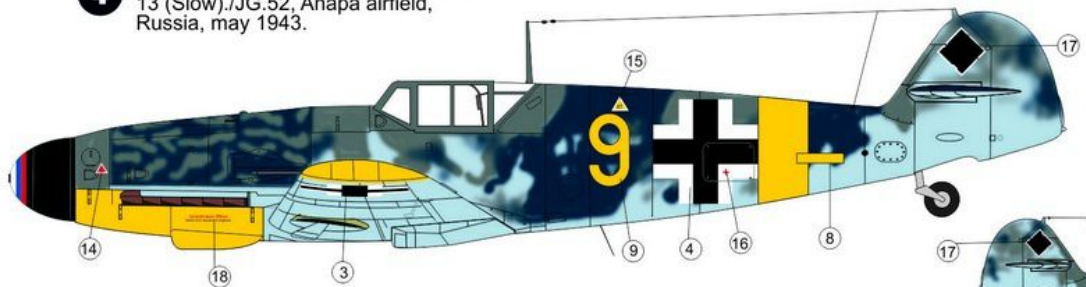

Paint Numbers:  
**HUMBROL**

<b>245</b>	<b>246</b>	<b>247</b>	<b>24</b>	<b>241</b>	<b>242</b>	<b>249</b>	<b>34</b>	<b>25</b>	<b>60</b>	<b>33</b>
DARK GREY RLM 74	GREY VIOLET RLM 75	LIGHT BLUE GREY RLM 76	YELLOW RLM 04	BLACK GREEN RLM 70	DARK GREEN RLM 71	SAND RLM 79	WHITE	BLUE	RED	BLACK

**AZ model**  
Plastic kits

Plastic model  
scale 1/72

# Messerschmitt Bf 109

## G-1, G-2, G-3, G-4, /Trop

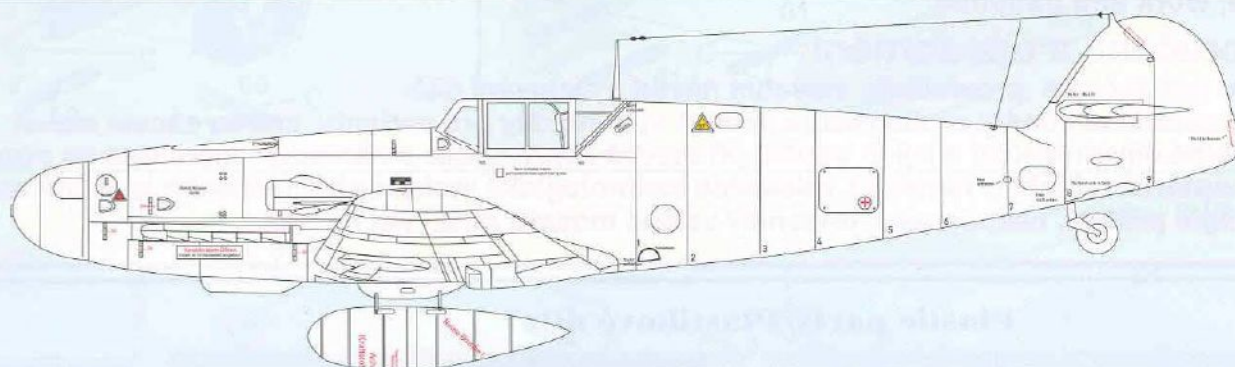

### History in brief

The Messerschmitt Bf 109, often called Me 109 (most often by Allied pilots and aircrew), was a German World War II fighter aircraft designed by Willy Messerschmitt and Robert Lusser during the early to mid-1930s. It was one of the first truly modern fighters of the era, including such features as all-metal monocoque construction, a closed canopy, a retractable landing gear, and was powered by a liquid-cooled, inverted-V12 aero engine.

The Bf 109 first saw operational service during the Spanish Civil War and was still in service at the dawn of the jet age at the end of World War II, during which time it was the backbone of the Luftwaffe's fighter force. From the end of 1941 the Bf 109 was supplemented by the Focke-Wulf Fw 190. Originally conceived as an interceptor, later models were developed to fulfill multiple tasks, serving as bomber escort, fighter-bomber, day-, night-, all-weather fighter, ground-attack aircraft, and as reconnaissance aircraft. It was supplied to and operated by several states during World War II, and served with several countries for many years after the war. The Bf 109 was the most produced fighter aircraft in history, with a total of 33,984 airframes produced from 1936 up to April 1945.

The Bf 109 was flown by the three top-scoring German fighter aces of World War II, who claimed 928 victories among them while flying with Jagdgeschwader 52, mainly on the Eastern Front, as well as by Hans-Joachim Marseille, the highest scoring German ace in the North African Campaign. It was also flown by several other aces from Germany's allies, notably Finn Ilmari Juutilainen, the highest scoring non-German ace on the type with 58 victories flying the Bf 109G, and pilots from Italy, Romania, Croatia, Bulgaria and Hungary. Through constant development, the Bf 109 remained competitive with the latest Allied fighter aircraft until the end of the war.

### Historie

Messerschmitt Bf 109, často nazývaný Me 109 (většinou spojeneckými piloty a posádkami), byl německý stíhací letoun z období II. světové války zkonstruovaný Willy Messerschmittem a Robert Lussem v pol. 30.let minulého století. Byl to jeden z prvních skutečně moderních stíhacích strojů své doby, vyznačující se celokovovou skořepinovou konstrukcí, uzavřenou kabinou a zatahovacím podvozkem. Byl poháněn kapalinou chlazeným 12ti válcovým invertním motorem. Poprvé byly Bf 109 operačně nasazeny během španělské občanské války a byl stále v provozu až do úsvitu proudového věku na konci druhé světové války. Koncem roku 1941 byl Bf 109 postupně nahrazován Focke-Wulfem Fw 190. Původním určením byl koncipován jako přepadový stíhač, později byly vyvinuty různé nové verze, které sloužily jako doprovod bombardérů, stíhací bombardér, denní a noční stíhač pro každé počasí a jako bitevní a průzkumný letoun. Byl dodáván a používán několika státy během druhé světové války a sloužil ještě mnoho let po ní. Bf 109 byl nepočteněji vyráběným stíhacím letounem v historii a celkem bylo vyrobeno 33.984 letounů od roku 1936 až do dubna 1945.

Na Bf 109 létali tři největší stíhací esa druhé světové války, kteří dosáhli 928 vítězství především na východní frontě. Na Bf 109 létal také Hans-Joachim Marseille, což je největší německé eso v severoafrickém tažení. Létali na něm také někteří další esa spojenců Německa např. Fin Ilmari Juutilainen s 58 vítězstvími, piloti z Itálie, Rumunska, Chorvatska, Bulharska, Slovenska a Maďarska. Díky neustálému vývoji Bf 109 dokázal držet krok s nejnovejšími spojeneckými stíhacími letouny až do konce II.světové války.

### Symbols/Symboly

Drill hole



Vyvrátat

Cyanoacrylate



Vteřinové lepidlo

Remove



Odstranit

Reduce



Zbrousit

Make new



Vyrobít

Option



Volba

Bend



Ohnout

Putty



Tmel

Colour name	Humbrol	Colour name	Humbrol
<b>A</b> RLM 22 Black	H33	<b>G</b> Aluminium	H56
<b>B</b> RLM 21 White	H34	<b>H</b> RAL 01 Silver	H11
<b>C</b> RLM 66 Black Grey	H67	<b>I</b> RLM 24 Blue	H25
<b>D</b> Gunmetal	H53	<b>J</b> RLM 23 Red	H60
<b>E</b> RLM 70 BlackGreen	H241	<b>K</b> RLM 02 Grey	H240
<b>F</b> RLM 04 Yellow	H24	<b>L</b> RLM 26 Brown	H113

### Drawings/Výkresy:

The last of the Egles/J.R.Beaman JR. Modelář 2/2006

### References/Podklady

Bf 109 in action part.2  
Bf 109G/K Kagero  
Aero detail 5 Bf 109G  
Suomen Ilmailuhistoriallinen Lehti  
Jagdwaaffe Bf 109  
Internet

## Read before you start:

- 1/ Before you begin, study carefully instructions, exploded drawings and numbering of parts.
- 2/ Prior your assembly, choose carefully your variant and remove all parts of it.
- 3/ Optional parts and theirs application compare with the picture on the box.
- 4/ Carefully remove parts, clean its and prior to applying adhesive, check to see whether the parts fit together.
- 5/ Assemble thoroughly, do not hurry. You will find that your finished model will reflect your time, work and patience.

## Doporučení a upozornění:

- 1/ Dříve než začnete ,prostudujte stavební návod a číslování dílů.
- 2/ Před začátkem stavby zvolte verzi a pečlivě vyberte díly pro variantu, kterou chcete stavět .
- 3/ Volitelné díly/možnosti a jejich použití při stavbě konfrontujte s náhledem markingu na obalu.
- 4/ Díly opatrně oddělte z rámečků, odstraňte technologické vtoky a před slepením je řádně začistěte.
- 5/ Pracujte pečlivě, nespěchejte, dokonalý vzhled modelu záleží jen na Vás.

### Plastic parts/Plastikové díly

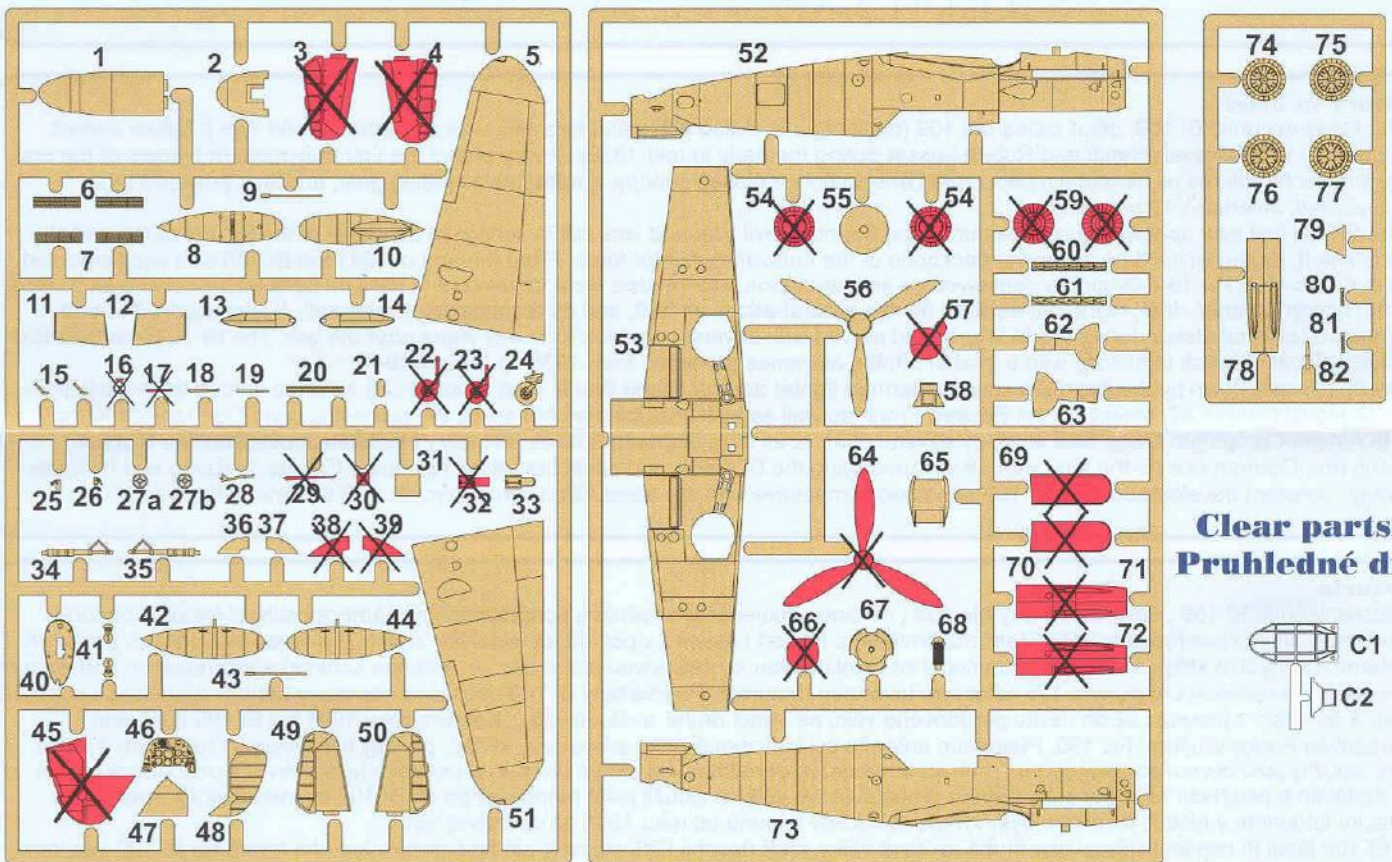

### Clear parts/ Pruhledné díly

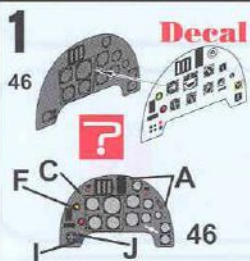

**2** **Port side console**  
Levá strana

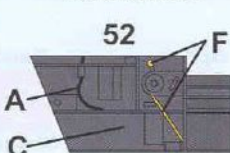

**Stanboard side console**  
Pravá strana

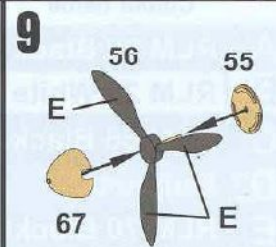
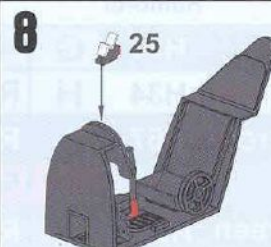
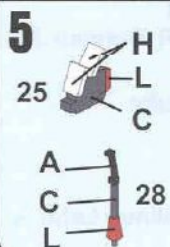
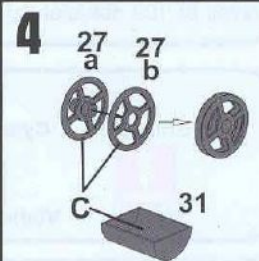
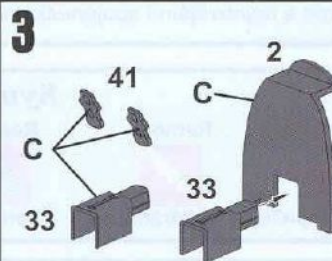
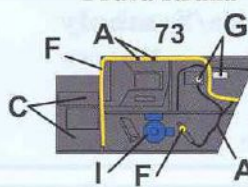

10

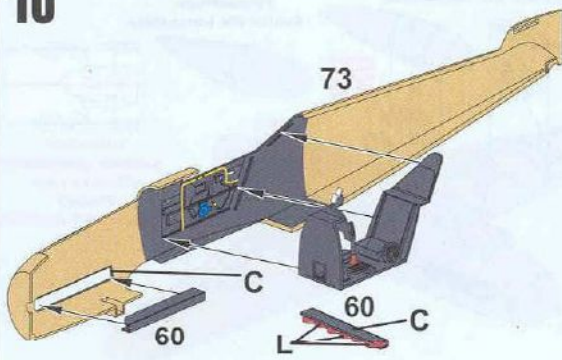

11

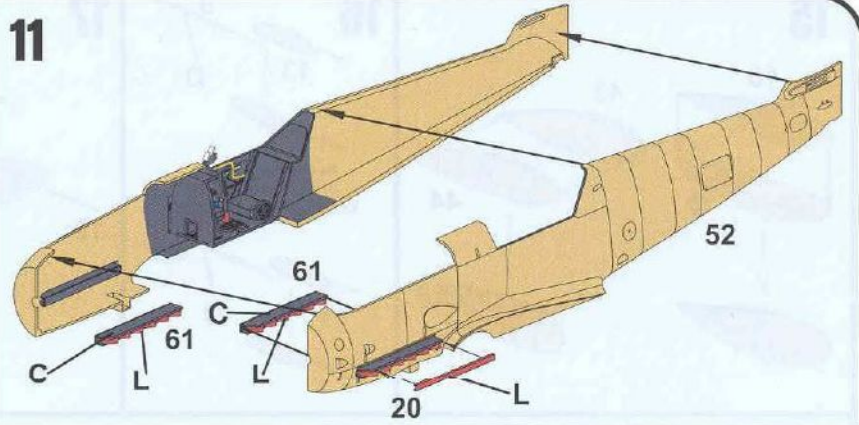

12

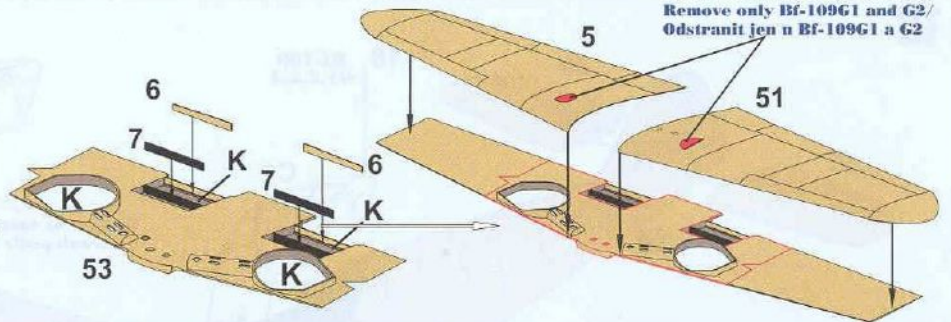
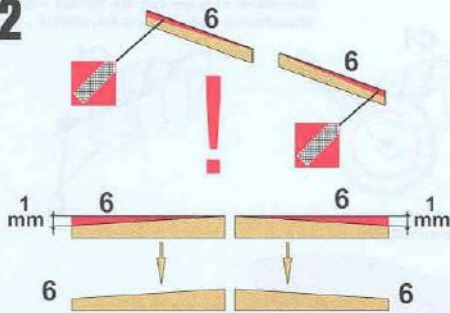

Remove only Bf-109G1 and G2/  
Odstranit jen u Bf-109G1 a G2

13

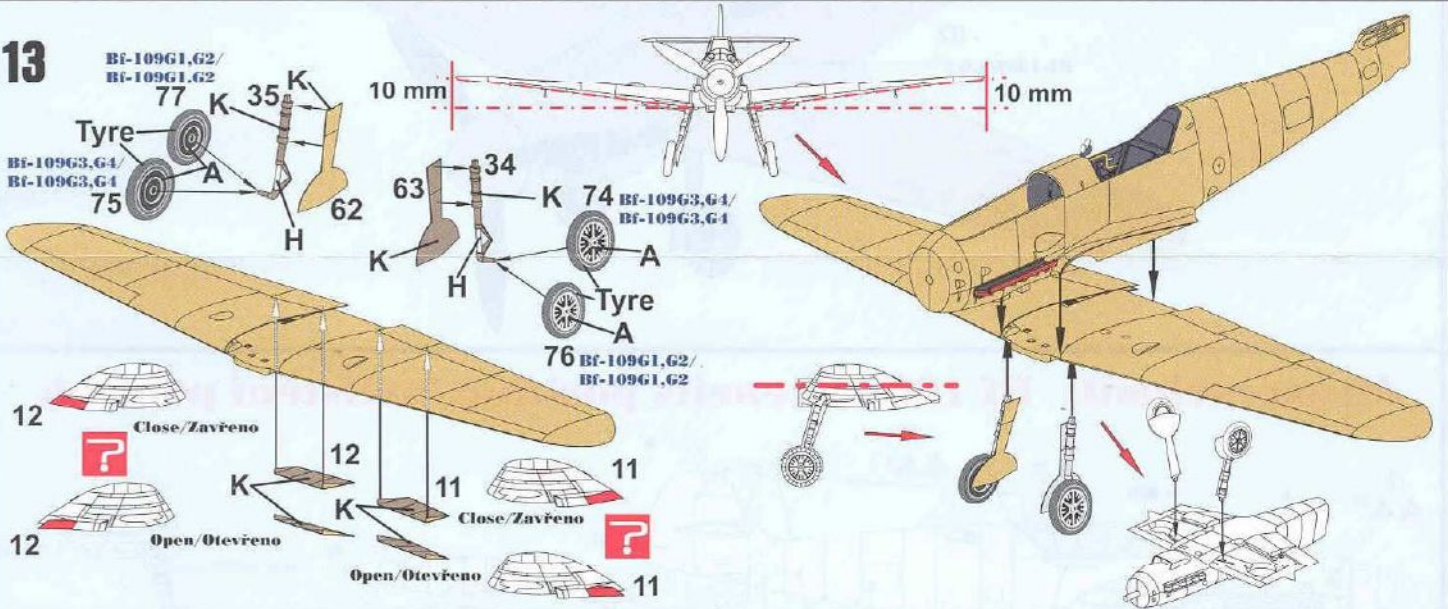

14

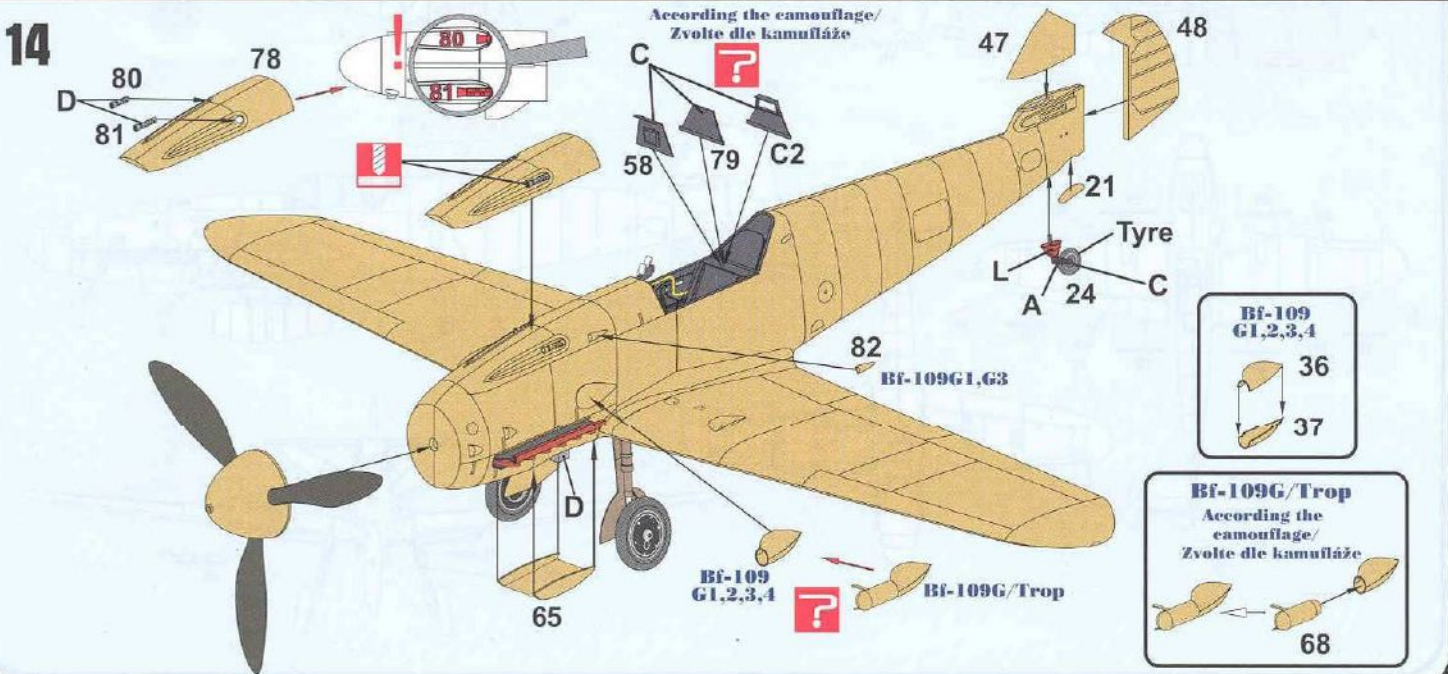

According to the camouflage/  
Zvolte dle kamufláže

Bf-109  
G1,2,3,4

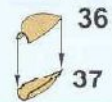

Bf-109G/Trop  
According to the camouflage/  
Zvolte dle kamufláže



15

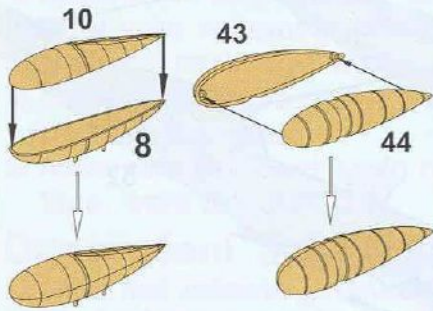

16

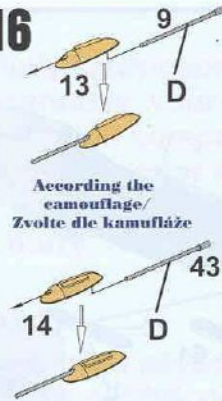

17

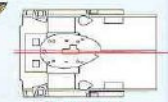
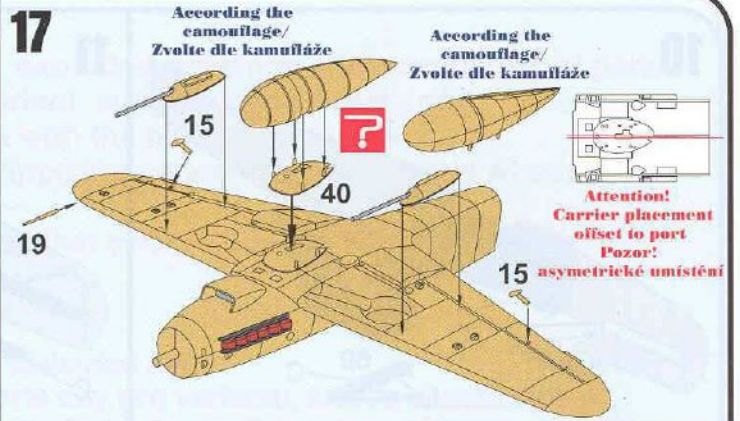

Attention!  
Carrier placement  
offset to port  
Pozor!  
asymetrické umístění

18

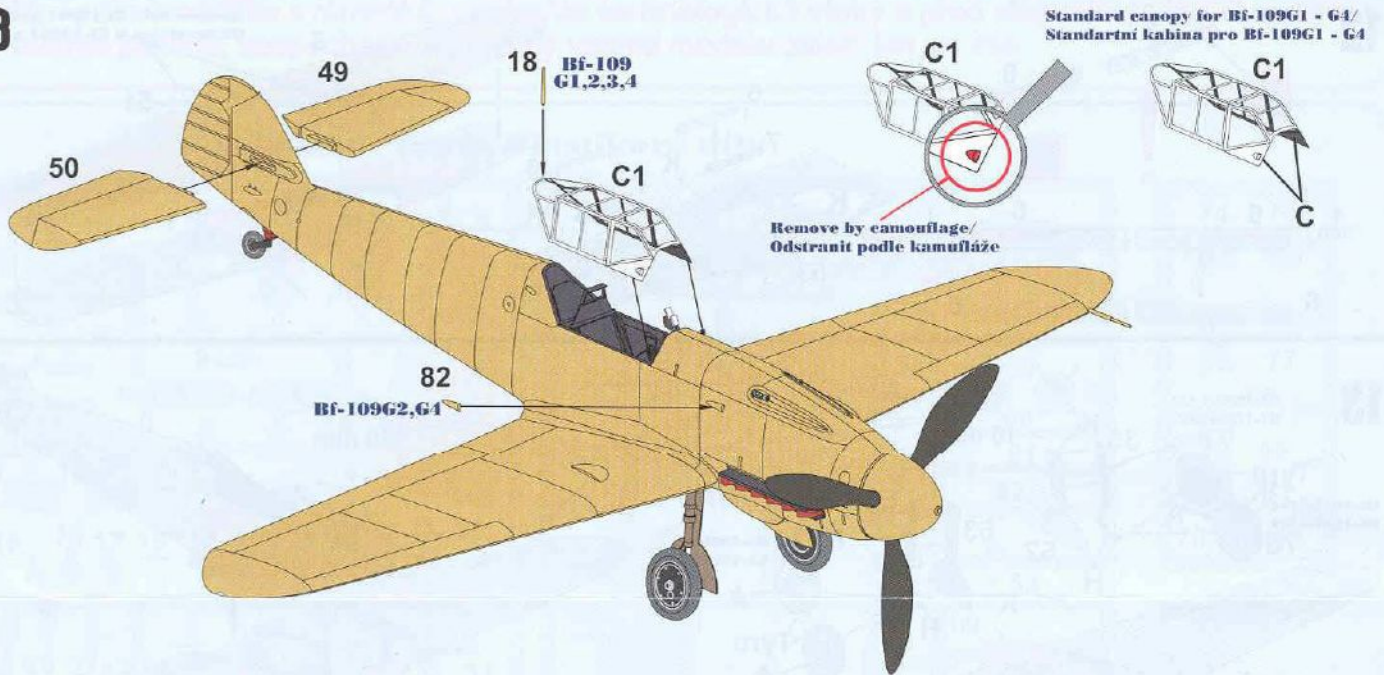

## Messerschmitt Bf 109G stencils position/umístění popisek

