

Colours & Markings

1

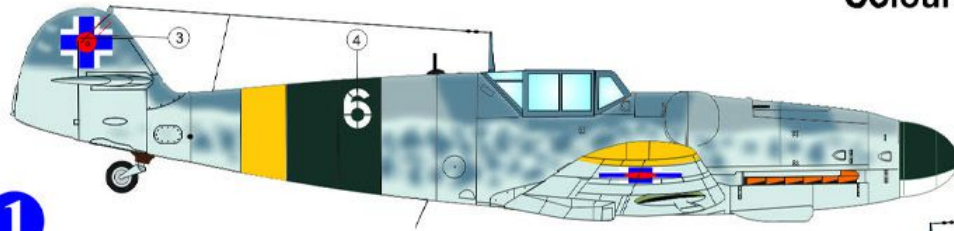

Bf 109G-6, White 6, Letka 13, Slovak Air Force, pilot zvk. P. Zelenak, 1944
Aircraft painted in standard German camouflage RLM 74/75/76 with Yellow bands and wingtips. Markings on fuselage overpainted by Dark Green colour.
This Bf 109 was damaged at forced landing after the attack on US B-24s on 26th June 1944.

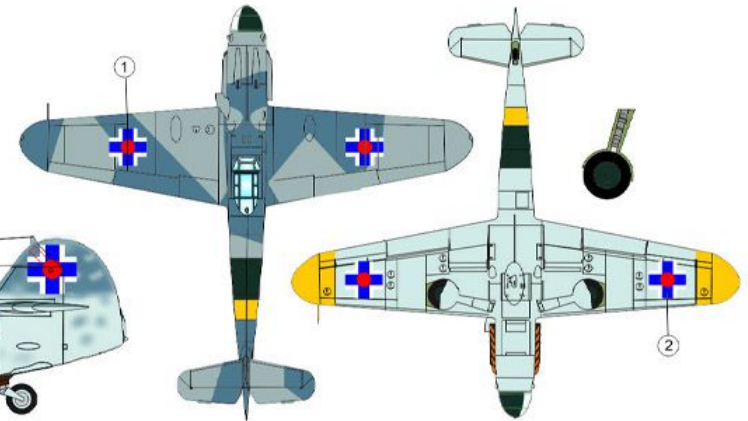
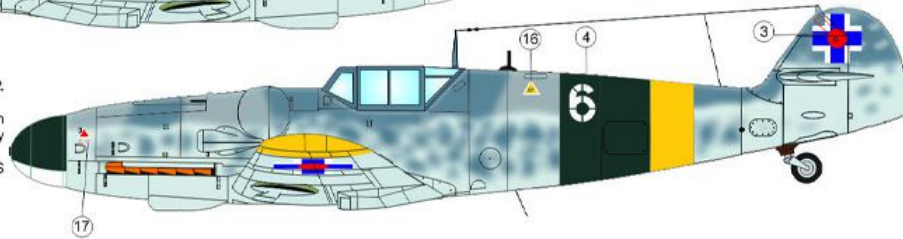

2

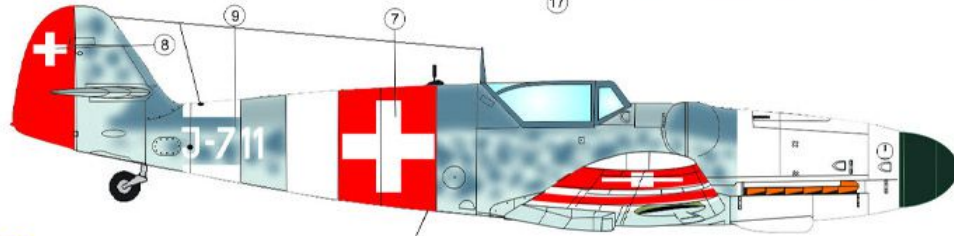

Bf 109G-6, J-711, Swiss Air Force, Interlaken, June 1944
This Bf 109 was delivered to Switzerland in May 1944 as the part of the second batch of 109G.
Painted in standard German camouflage RLM 74/75/76, it has complete neutrality markings.
Note the white moon on horizontal tail surface.

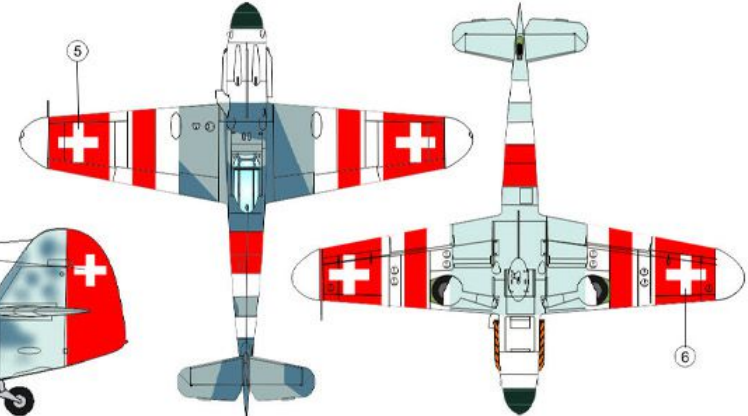
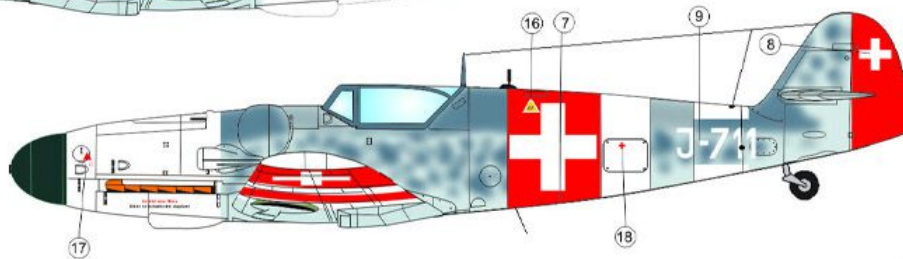

3

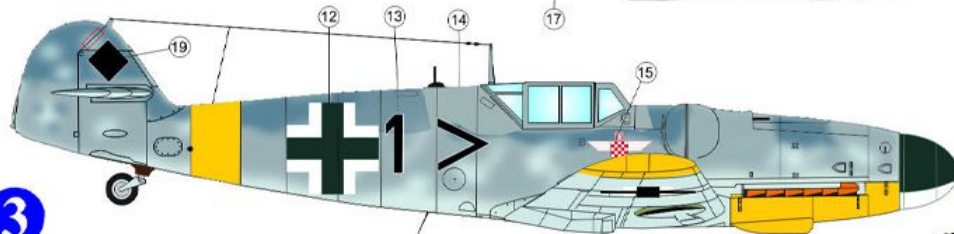

Bf 109G-6, Black 1, 15.(Kroat)/JG52, pilot Staffelkapitan Mato Dukovac, Kroat aces No 1., Crimea Russia, April 1944.
Messerschmitt piloted by Croatian ace pilot was painted in standard camouflage scheme RLM 74/75/76 with yellow supplements typical for Eastern Front. 40+5 victories
Note the unit badge on fuselage sides.

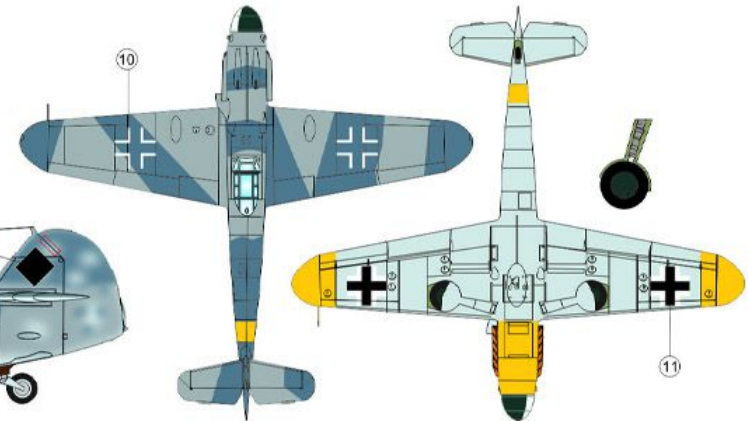
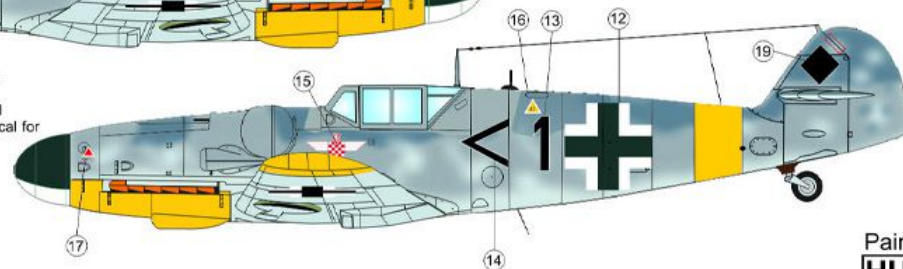

245	246	247	241
RLM 74 Dark Grey	RLM 75 Grey Violet	RLM 76 Light Blue Grey	RLM 70 Black Green

Paint Numbers:
HUMBROL

60	34	24
Red	White	RLM 04 Yellow

AZ model
Plastic kits

Messerschmitt Bf-109

variants G5/G6/G8/G14

Plastic model
scale 1/72

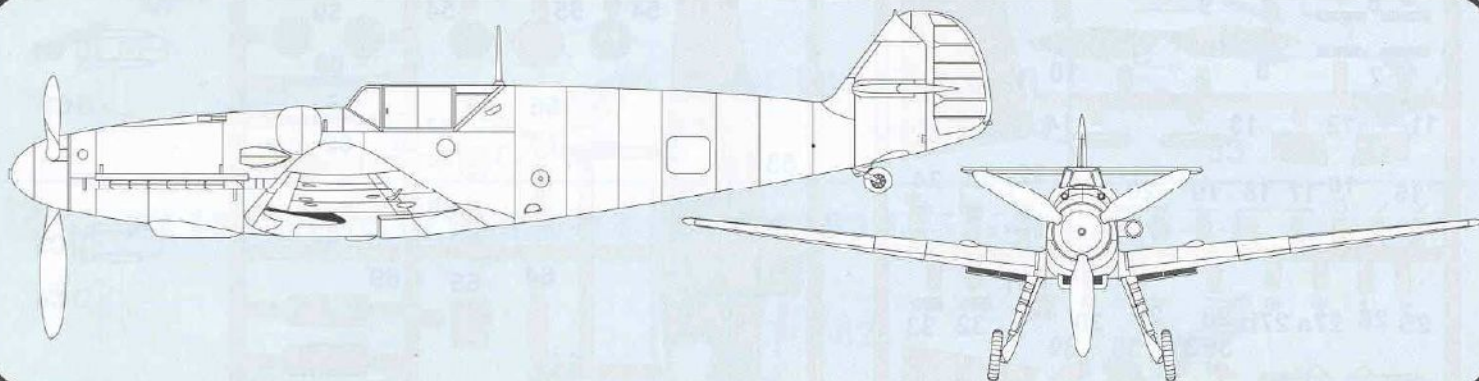

Historie

Messerschmitt Bf 109, často nazývaný Me 109 (většinou spojeneckými piloty a posádkami), byl německý stíhací letoun z období II. světové války zkonstruovaný Willy Messerschmittem a Robert Lussem v pol. 30.let minulého století. Byl to jeden z prvních skutečně moderních stíhacích strojů své doby, vyznačující se celokovovou skořepinovou konstrukcí, uzavřenou kabinou, zatahovacím podvozkem. Byl poháněn kapalinou chlazeným 12ti válcovým invertním motorem. Poprvé byly Bf 109 operačně nasazeny během španělské občanské války, a byl stále v provozu až do úsvitu proudového věku na konci druhé světové války. Koncem roku 1941 byl Bf 109 postupně nahrazován Focke-Wulfem Fw 190. Původním určením byl koncipován jako přepadový stíhač, později byly vyvinuty různé nové verze, které sloužily jako doprovod bombardérů, stíhací bombardér, denní a noční stíhač pro každé počasí a jako bitevní a průzkumný letoun. Byl dodáván a používán několika státy během druhé světové války a sloužil ještě mnoho let po ní. Bf 109 byl nepoččetně vyráběným stíhacím letounem v historii a celkem bylo vyrobeno 33.984 letounů od roku 1936 až do dubna 1945.

Na Bf 109 létali tři největší stíhací esa druhé světové války, kteří dosáhli 928 vítězství především na východní frontě. Na Bf 109 létal také Hans-Joachim Marseille, což je největší německé eso v severoafrické tažení. Létali na něm také někteří další esa spojenců Německa např. Finn Ilmari Juutilainen s 58 vítězstvími, piloti z Itálie, Rumunska, Chorvatska, Bulharska, Slovenska a Maďarska. Díky neustálému vývoji Bf 109 dokázal držet krok s nejnovějšími spojeneckými stíhacími letouny až do konce II. světové války.

History in brief

The Messerschmitt Bf 109, often called Me 109 (most often by Allied pilots and aircrew), was a German World War II fighter aircraft designed by Willy Messerschmitt and Robert Lusser during the early to mid-1930s. It was one of the first truly modern fighters of the era, including such features as all-metal monocoque construction, a closed canopy, a retractable landing gear, and was powered by a liquid-cooled, inverted-V12 aero engine.

The Bf 109 first saw operational service during the Spanish Civil War and was still in service at the dawn of the jet age at the end of World War II, during which time it was the backbone of the Luftwaffe's fighter force. From the end of 1941 the Bf 109 was supplemented by the Focke-Wulf Fw 190. Originally conceived as an interceptor, later models were developed to fulfill multiple tasks, serving as bomber escort, fighter-bomber, day-, night-, all-weather fighter, ground-attack aircraft, and as reconnaissance aircraft. It was supplied to and operated by several states during World War II, and served with several countries for many years after the war. The Bf 109 was the most produced fighter aircraft in history, with a total of 33,984 airframes produced from 1936 up to April 1945.

The Bf 109 was flown by the three top-scoring German fighter aces of World War II, who claimed 928 victories among them while flying with Jagdgeschwader 52, mainly on the Eastern Front, as well as by Hans-Joachim Marseille, the highest scoring German ace in the North African Campaign. It was also flown by several other aces from Germany's allies, notably Finn Ilmari Juutilainen, the highest scoring non-German ace on the type with 58 victories flying the Bf 109G, and pilots from Italy, Romania, Croatia, Bulgaria and Hungary. Through constant development, the Bf 109 remained competitive with the latest Allied fighter aircraft until the end of the war.

Symbols



Open hole



Cyanoacrylate



Remove



Reduce



To make new



Option



To bend



Putty

	Colour name	Humbrol		Colour name	Humbrol
A	RLM 22 Black	H33	G	Aluminium	H56
B	RLM 21 White	H34	H	RAL 01 Silver	H11
C	RLM 02 Grey	H79	I	RLM 24 Blue	H25
D	Gunmetal	H53	J	RLM 23 Red	H60
E	RLM 70 BlackGreen	H91	K	RLM 66 BlackGrey	H32
F	RLM 04 Yellow	H21	L	RLM 26 Brown	H113

References:

Drawings:

The last of the Eagles/J.R.Beaman JR.

Bf 109 in action part.2

Bf 109G/K Kagero

Aero detail 5 Bf 109G

Suomen Ilmailuhistoriallinen Lehti internet

Plastic parts

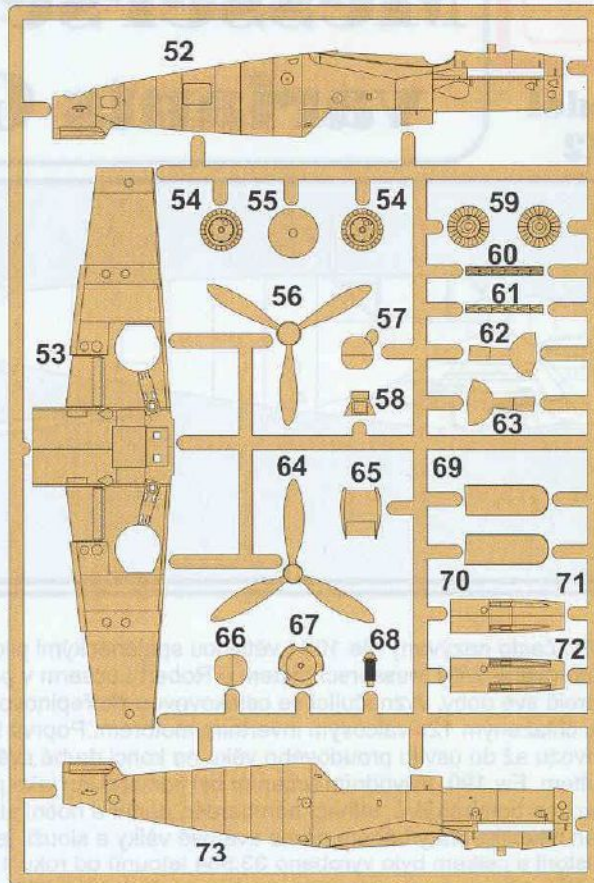
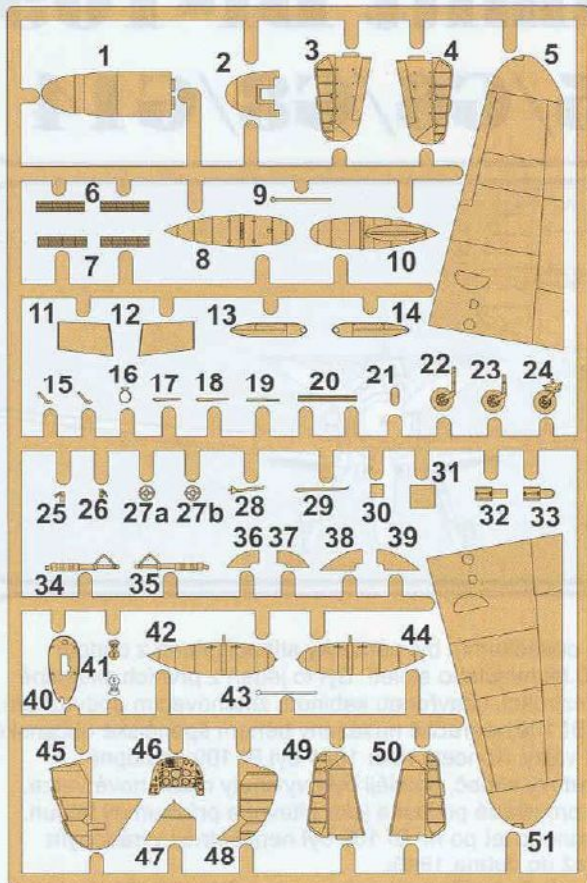

Clear parts

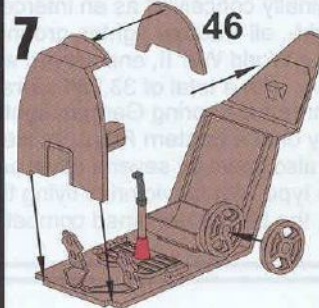
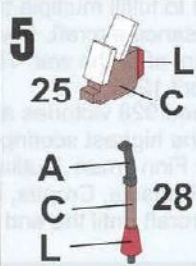
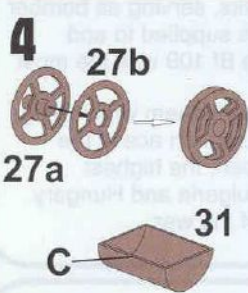
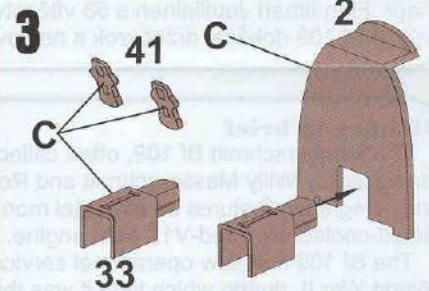
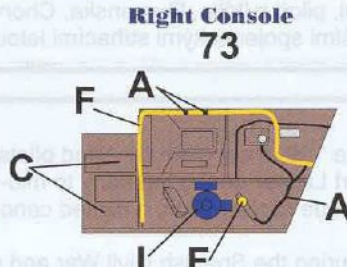
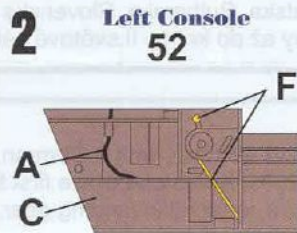
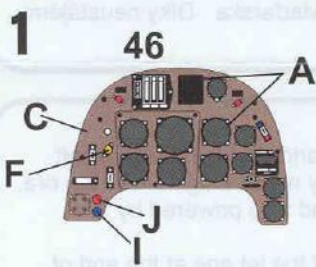
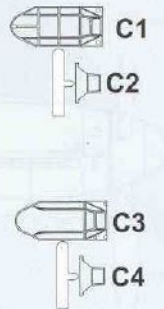

9 Bf 109 G-5, G-6, G-8, G-14

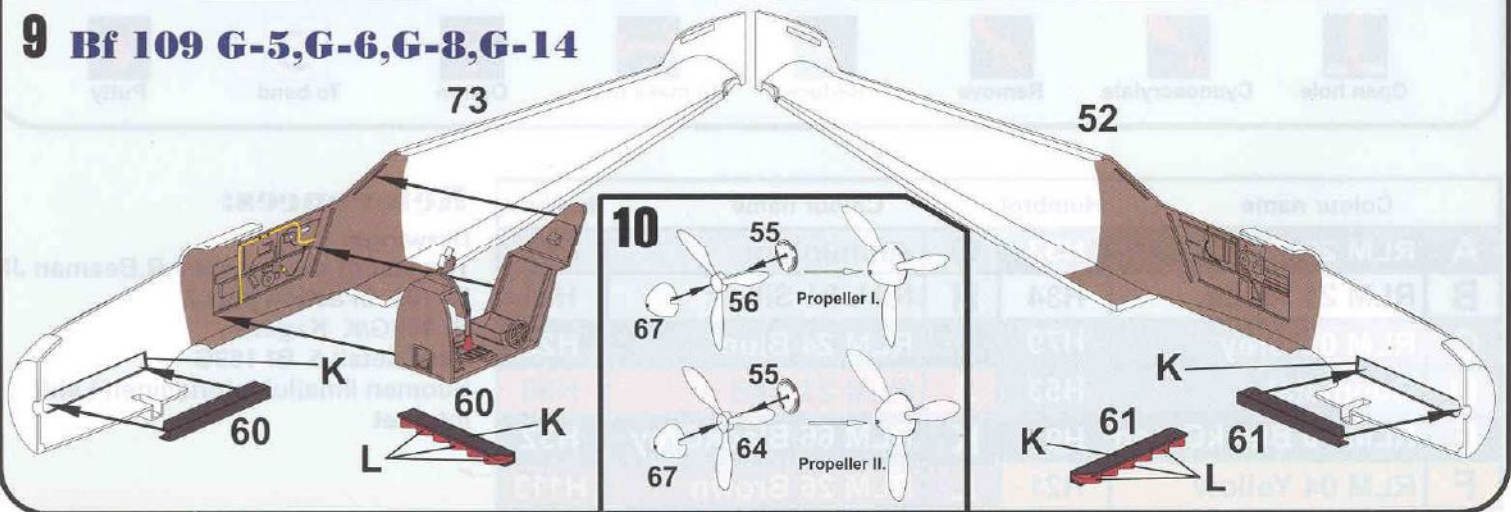

11

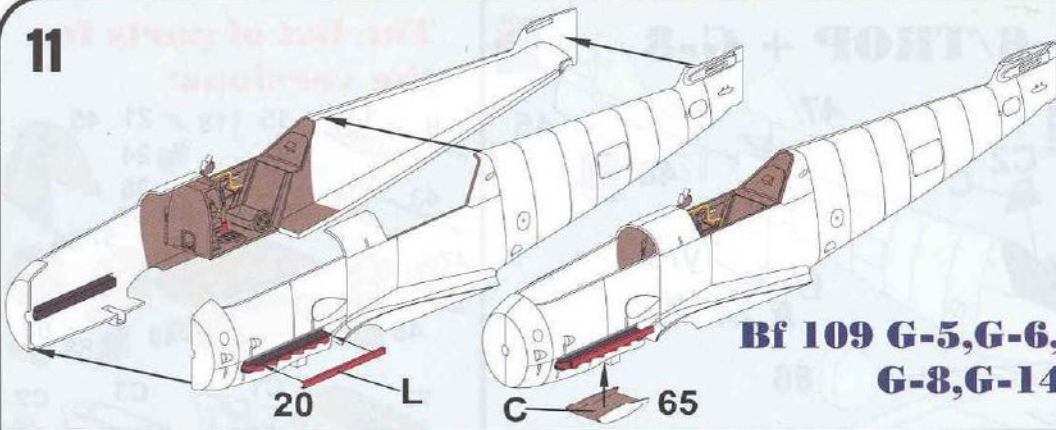

Bf 109 G-5, G-6, G-8, G-14

12 **Bf 109 G-5, G-6, G-8, G-14**

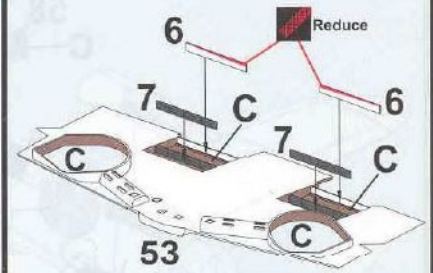

13 **Bf 109 G-5, G-6, G-8, G-14**

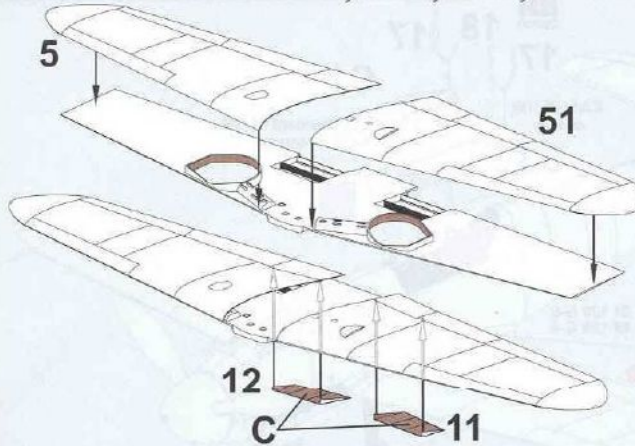

14 **Bf 109 G-5, G-6, G-8, G-14**

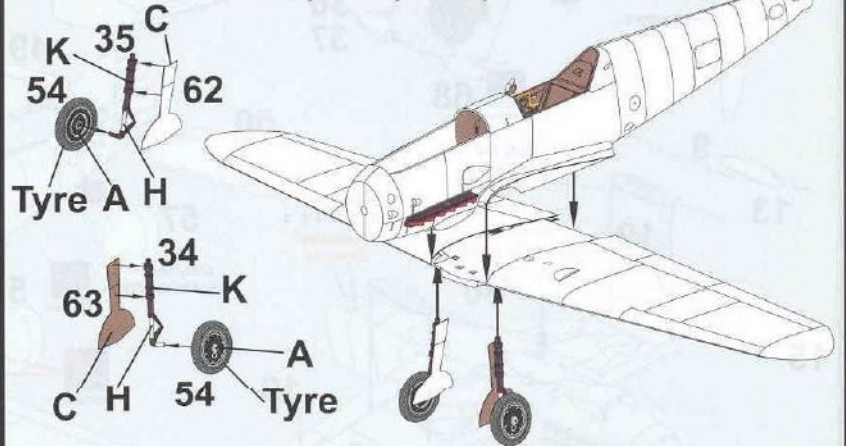

15 **Bf 109 G-5, G-5/TROP**

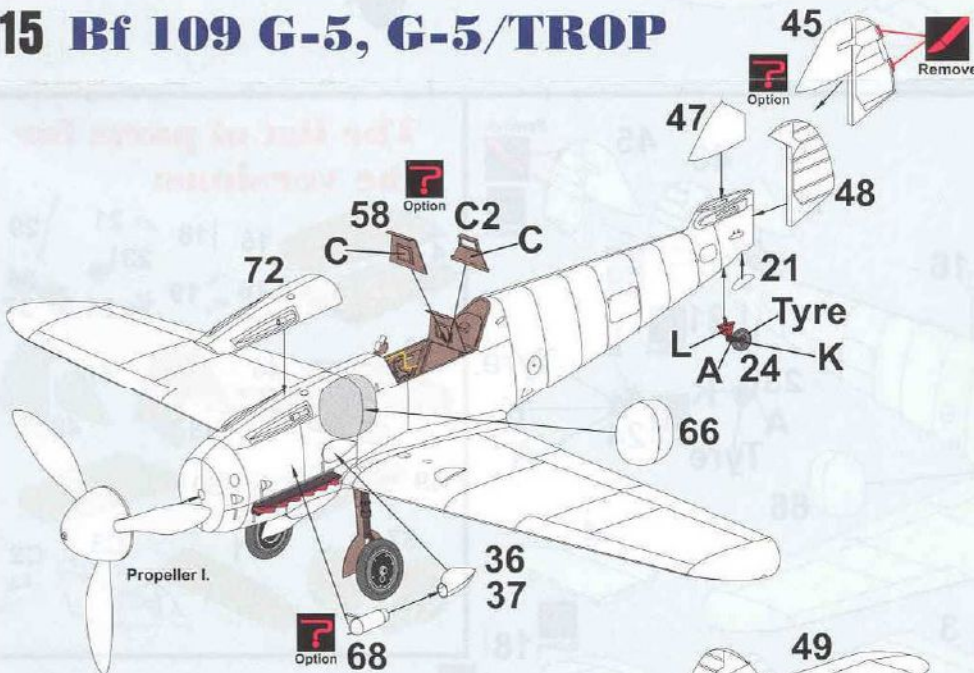

The list of parts for the versions:

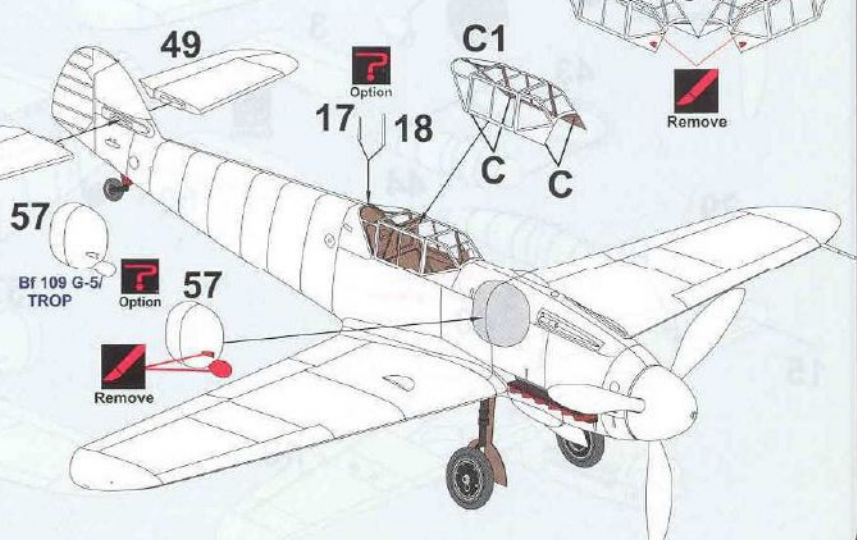
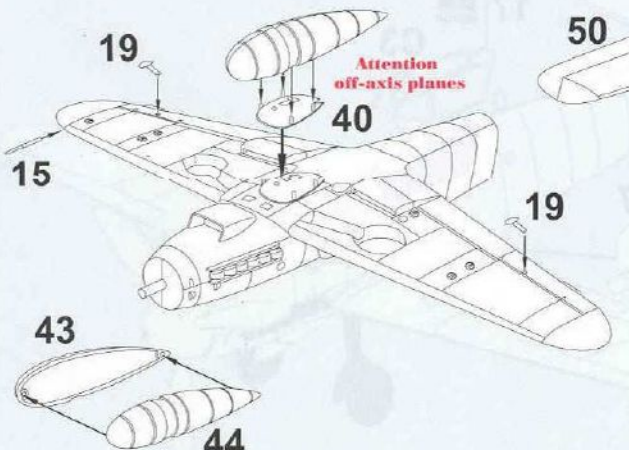
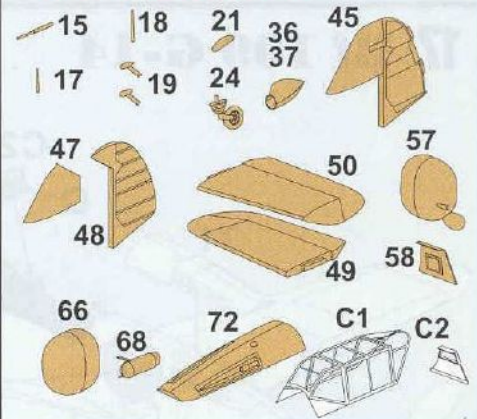

Standard Bf 109 canopy



Remove

Bf 109 G-5/TROP

Remove

16 Bf 109 G-6, G-6/TROP + G-8

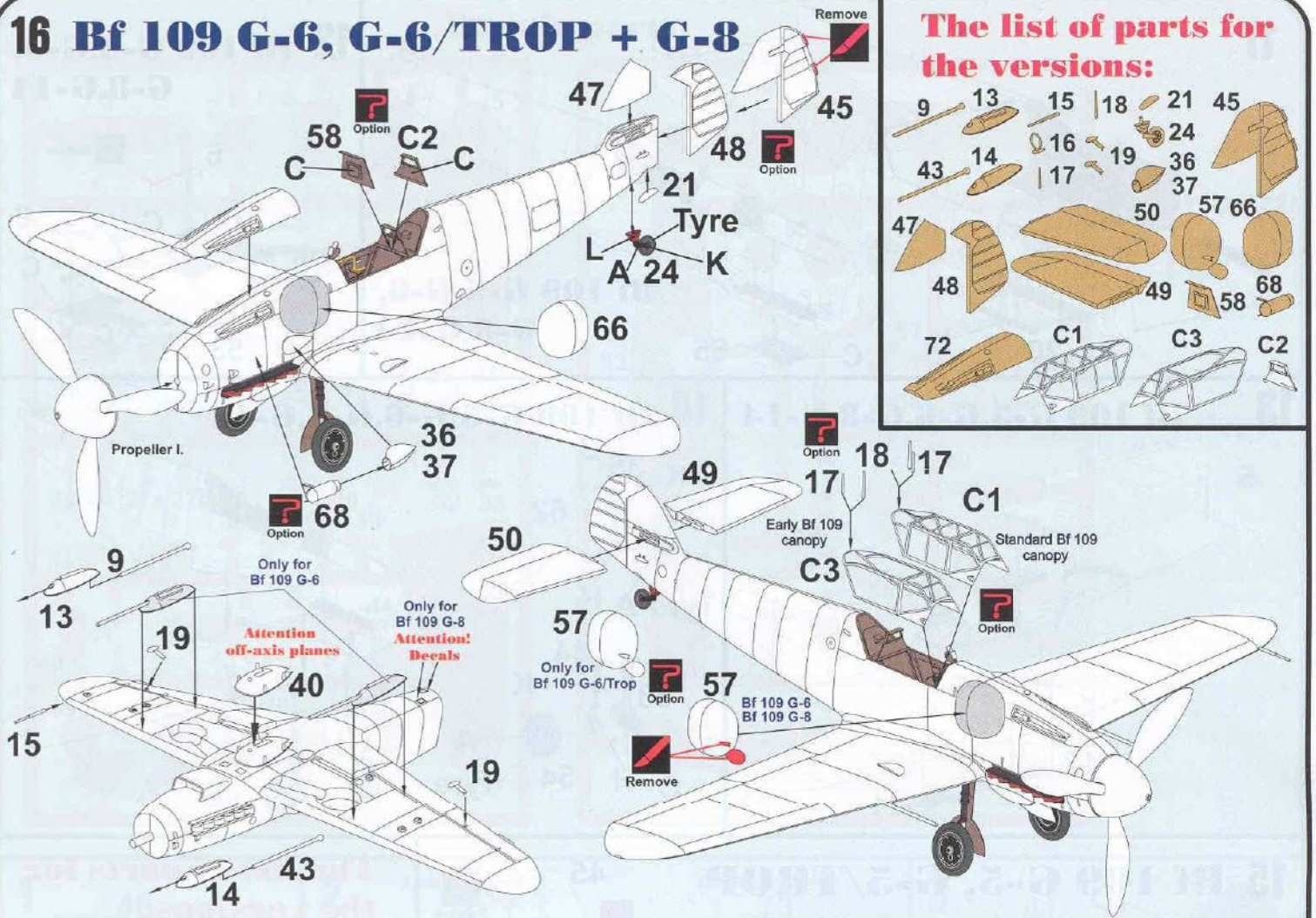

The list of parts for the versions:

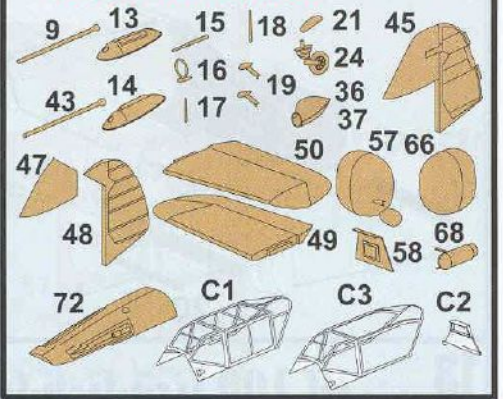

17 Bf 109 G-14

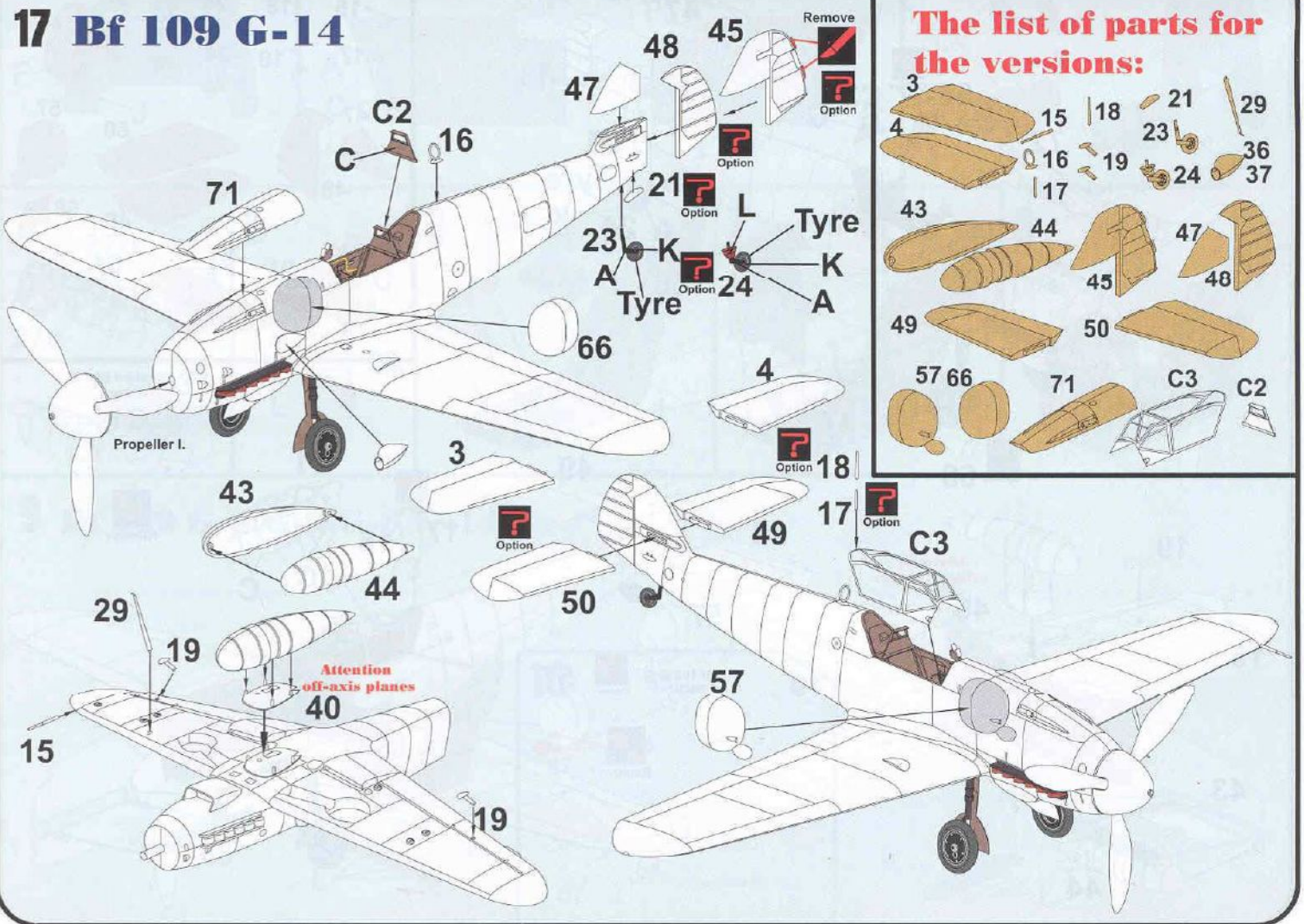

The list of parts for the versions:

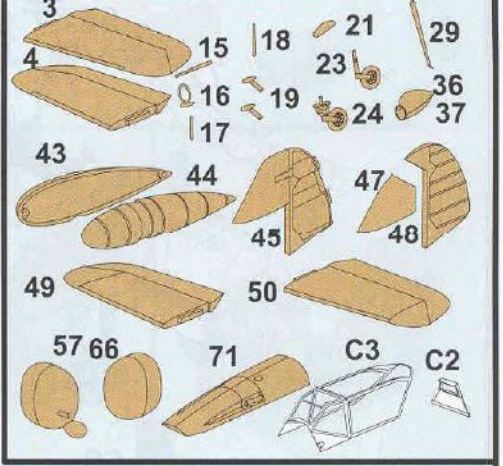

Messerschmitt Bf 109G stencils position:

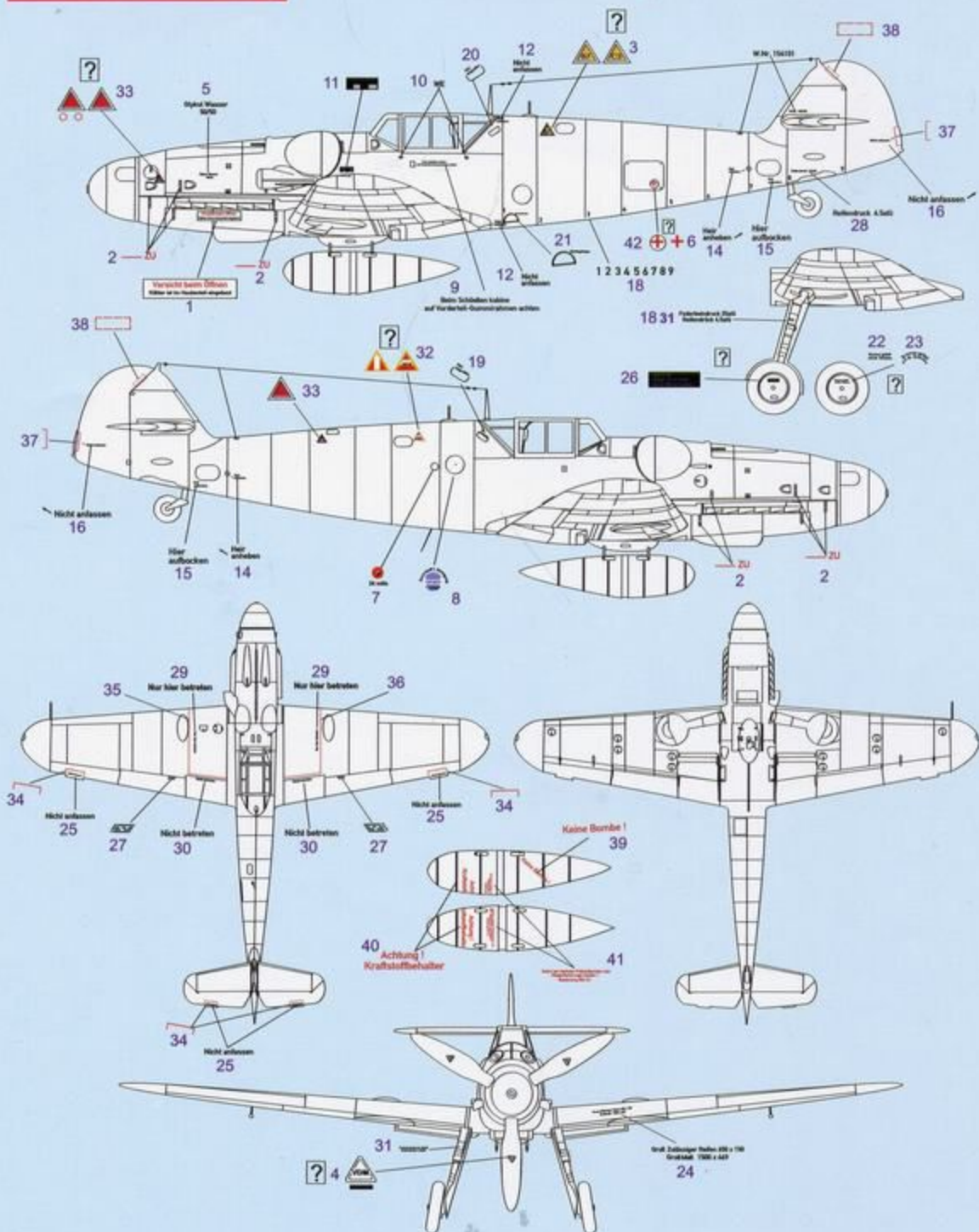

Warning: cockpit color

C

RLM 66 Black Grey

H67