

Zbarvení & Označení Colours & Markings

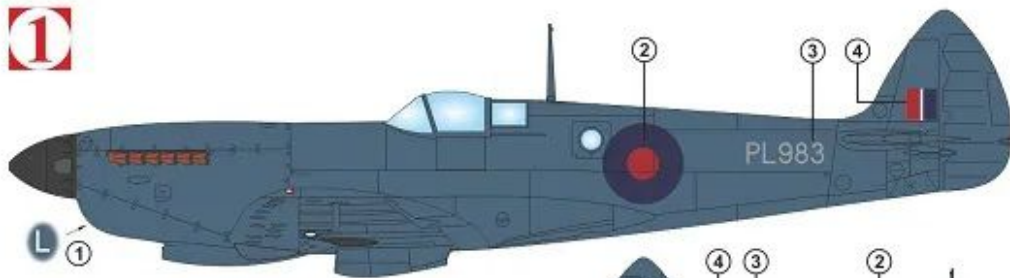

Spitfire PR. Mk. XI, PL 983, L, 4. perut' RAF, základna Gilze-Rijen, Holandsko, 1945

Celý letoun je zbarven modrým odstínem PRU Blue. Vrtulové listy černé se žlutými konci. Vrtulový kužel zbarven černě.

Spitfire PR. Mk. XI, PL 983, L, No. 4 Squadron RAF, Gilze-Rijen AB, Netherlands, 1945

Aircraft painted in PRU Blue overall. Propeller blades painted in Black with Yellow tips. Spinner in Black.



PRU modrá
PRU Blue

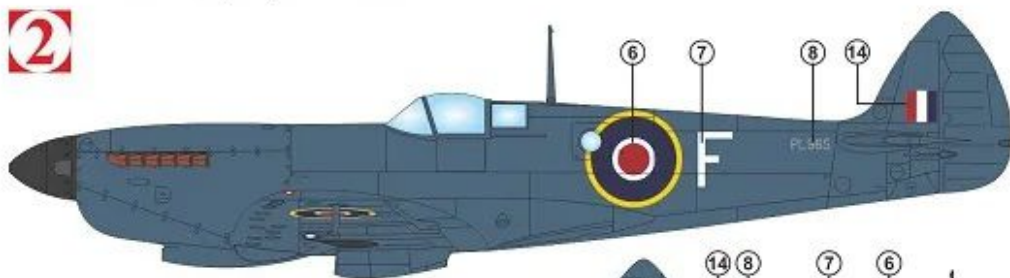
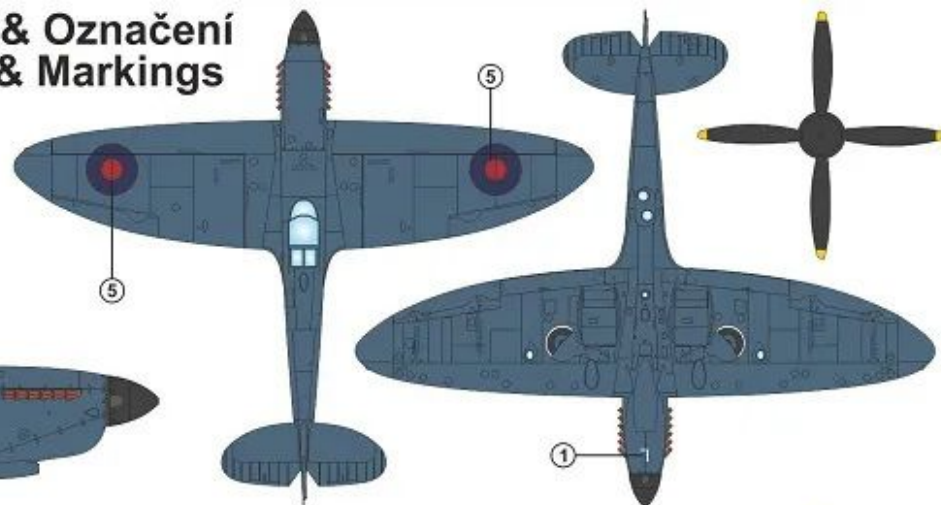

Spitfire PR. Mk. XI, PL 965, F, 16. perut' RAF, 2. TAF, Holandsko, 1945

Celý letoun v modré barvě PRU Blue. Vrtule černá se žlutými konci listů, kužel černý.

Spitfire PR. Mk. XI, PL 965, F, No. 16 Squadron RAF, 2nd TAF, Netherlands, 1945

Aircraft painted in PRU Blue overall. Propeller painted in Black with Yellow tips, spinner in Black.



Výfuky
Exhausts

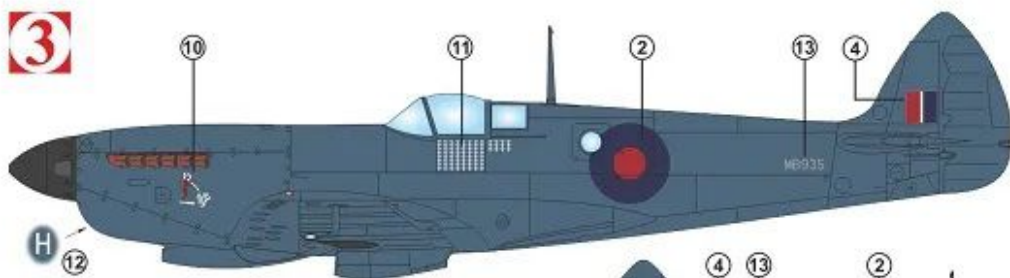
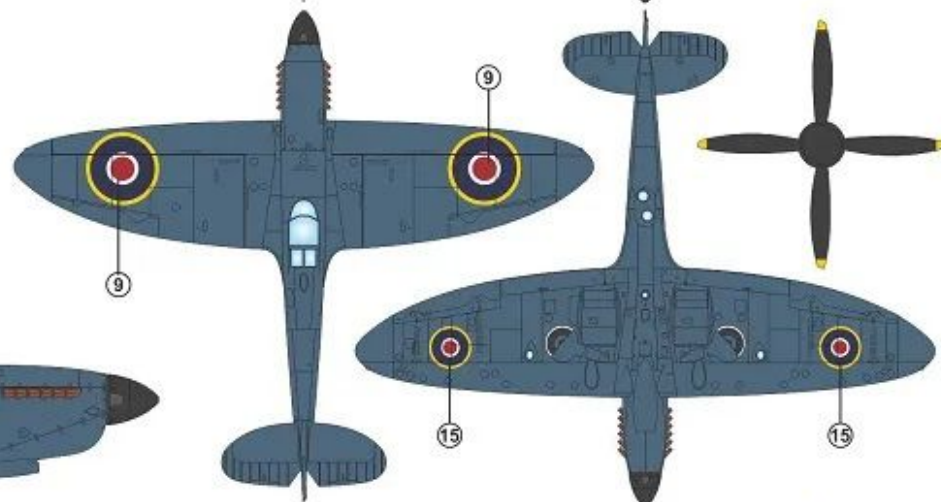

Spitfire PR. Mk. XI, PL 935, H, 16. perut' RAF, pilot F/Lt Eric Martin, 1944

Celý letoun v modré barvě PRU Blue. Vrtule černá se žlutými konci listů, kužel černý.

Spitfire PR. Mk. XI, PL 935, H, No. 16 Squadron RAF, flown by F/Lt Eric Martin, 1944

Aircraft painted in PRU Blue overall. Propeller painted in Black with Yellow tips, spinner in Black.



Černá
Black



Žlutá
Yellow

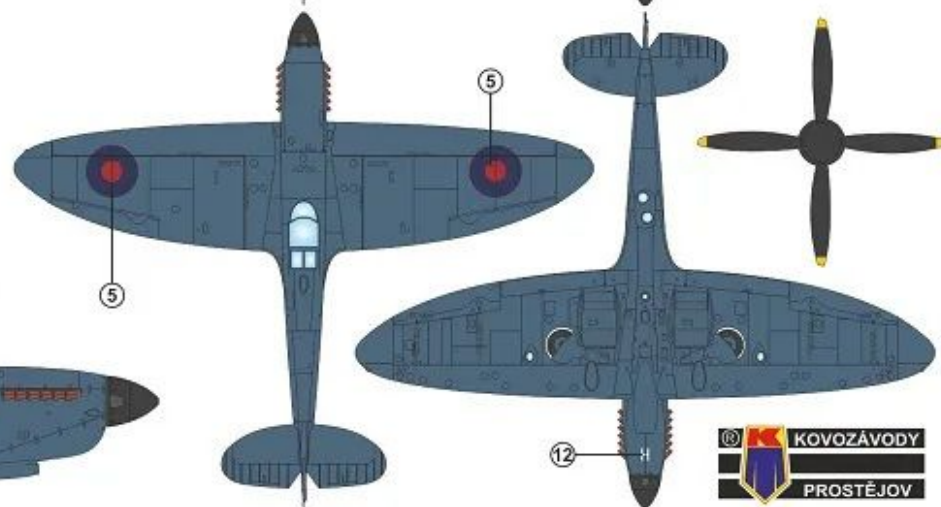

17

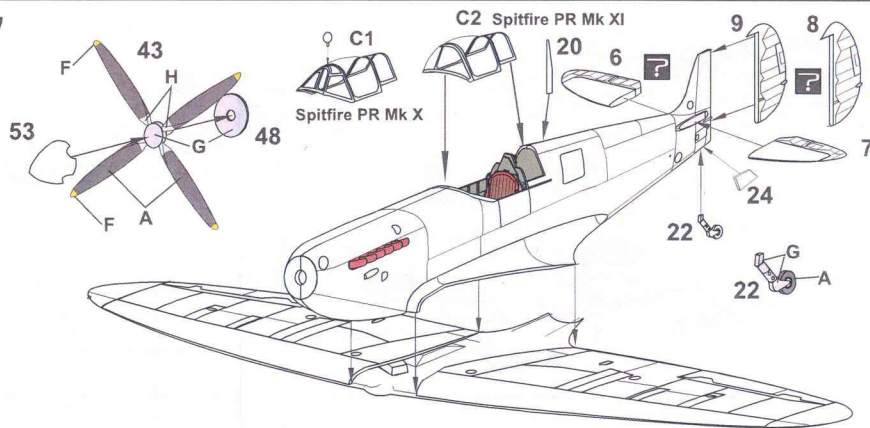

18

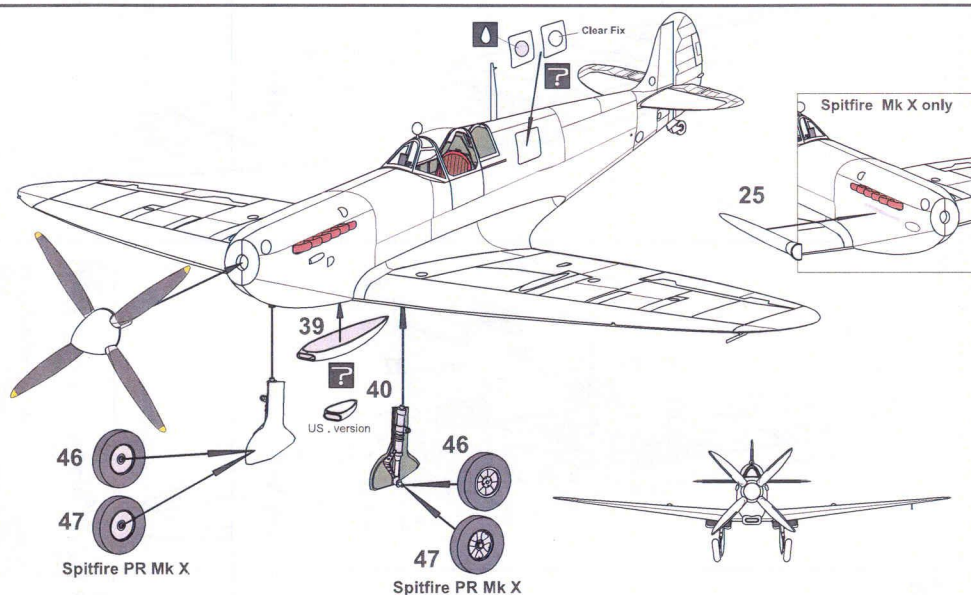

Stencils Spitfire PR Mk X, XI

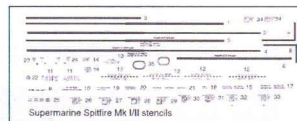
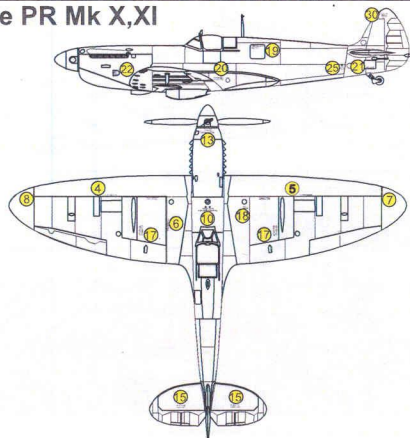

SPITFIRE

PR Mk X, PR Mk XI

Na počátku roku 1942 byla převaha nového německého letounu Focke Wulf Fw 190A nad Spitfirey verze Mk. V naprosto zřetelná. RAF požadovalo urychlené zavedení výroby Spitfireů s novým výkonnějším motorem Merlin 61. Konstruktivní práce na verzích Mk. VII a VIII byly v plném proudu, ale jejich dokončení vyžadovalo ještě nejméně rok a potřeba rovnocenného soupeře pro Fw 190 tolik času nedávala. Ministerstvo letectví tedy rozhodlo konvertovat draky verze Spitfire Mk. Vc a montovat do nich nové výkonnější motory Merlin. První Spitfirey IX byly tedy takto konvertovány a postrádaly mnohá vylepšení, postupně zaváděná do výroby. Ačkoliv nová verze Mark IX neměla aerodynamická zjemnění nebo upravené řídicí plochy plánované pro verze VII a VIII, ukázala se být obávanému Fw 190 více než rovnocennou. Verze Mk. IX se stala mezi Spitfirey nejpochetnější a byla páteří stíhacích perutí RAF až do konce války.

Verze Spitfire PR Mk.X/XI byly nevyzbrojené průzkumné varianty pocházející původem z verzí MkVII/VIII.

In the early months of 1942, with the clear superiority of the Focke Wulf Fw 190 over the Spitfire VB, there was much pressure to get Spitfires into production using the new two-stage supercharged Merlin 61 engine. Although design work on the Mk VII and VIII series was under way, these would take over a year to get into production and a counter to the Fw 190 was urgently needed. The Air Ministry made the decision that Mk VC airframes should be converted to take the more powerful engine and, as a result, many of the early IXs were converted Mk VCs which did not have any of the refinements which later appeared.

Although the Mk IX's airframe did not have the aerodynamic and strength improvements, or the modified control surfaces of the Mk VII and VIII, the Mk IX still proved to be an effective counter to the Focke Wulf Fw 190.

The Mark IX became the most numerous Spitfire version and was the backbone of the RAF fighter squadrons until the end of war.

The Spitfire PR Mk.X / XI versions were unarmed reconnaissance variants originating from the MkVII / VIII versions.

TECHNICKÁ DATA: / TECHNICAL DATA:

Délka/Length:	11,23m
Rozpětí/Wing span:	9,54m
Výška/Height:	3,84m
Nosná plocha/Wing area:	22,48m ²
Hmotnost prázdná/Empty weight:	2 630kg
Vzletová hmotnost/Take-off weight:	3 450kg
Motor/Powerplant:	Rolls Royce Merlin 66 1 178kW
Max. rychlost/Max. speed:	662km/h
Dolět/Range:	1 580km
Dostup/Service ceiling:	12 900m

REALIZAČNÍ TÝM: / REALISATION TEAM:

Předlohový model:	Petr Muzikant
Master model:	
Koordinace výroby:	Petr Muzikant
Production coordination:	
Formy a výroba:	Pavel Vandělik
Moulds and production:	
Titulní kresba:	Carlos Alonso
Box art:	
Návod:	
Instruction leaflet:	G.Hýbner
Grafika a návrh obtisků:	Jan Polc
Graphic design, decals:	
Tisk obtisků:	KP
Decal printer:	
Konzultanti:	Slavomír Goldemund
Consultants:	Miroslav Balous
	Jaroslav Vělc
	Michal Ovcáčík

Realizační tým KP velmi děkuje za velkou pomoc a asistenci při přípravě tohoto modelu všem, kteří poskytli materiály ze svých osobních sbírek.

The KP realization team gratefully acknowledges the co-operation of all who provided materials from their personal collections and thus enabled the preparation of this model.

Symbols



Option



Open hole



Putty



Remove

Před zahájením stavby si prostudujte návod. Používejte pouze vhodné nářadí, lepidlo a barvy. Během práce nejzte a nepijte. POZOR - obsahuje malé součásti, které mohou mít ostré hrany. Není vhodné pro děti.

Read carefully the instruction leaflet before assembly. Use proper tools, glue and paints. Do not eat and drink during the work. WARNING - contains small parts with possible sharp edges. Not suitable for children.

Plastic parts

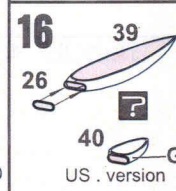
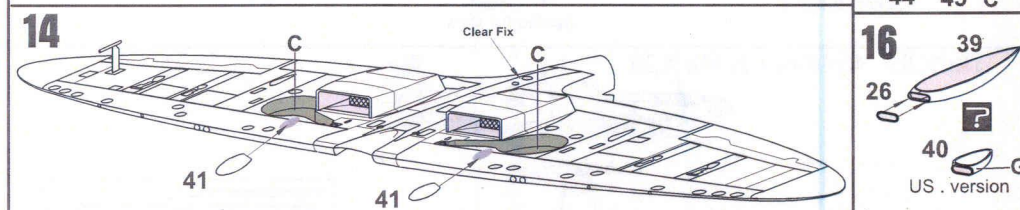
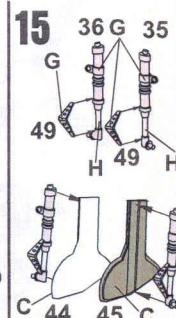
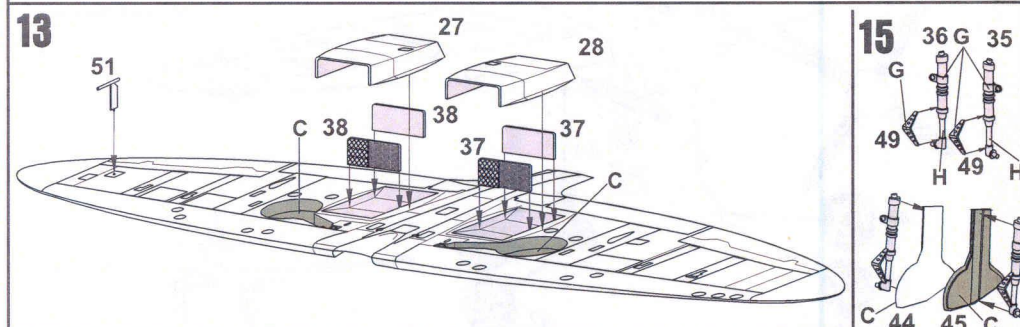
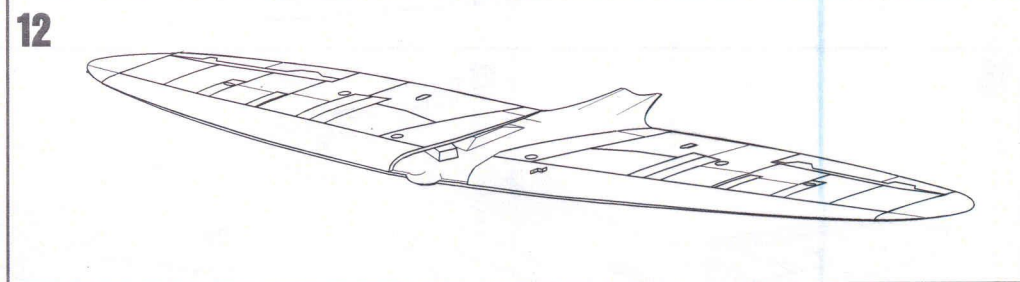
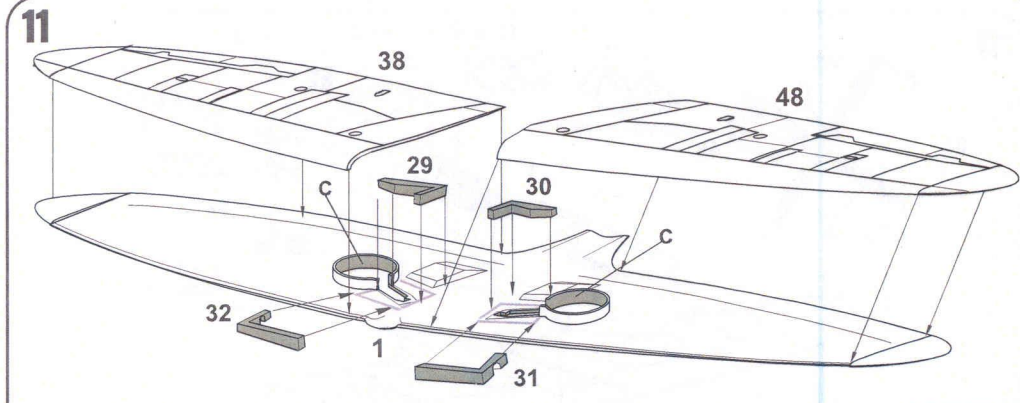
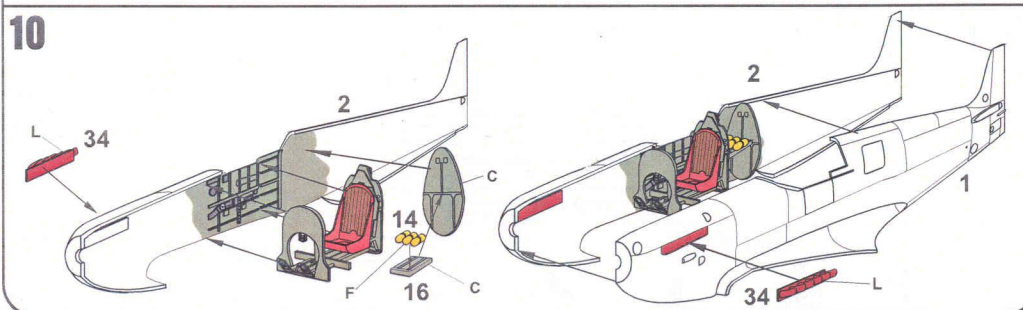
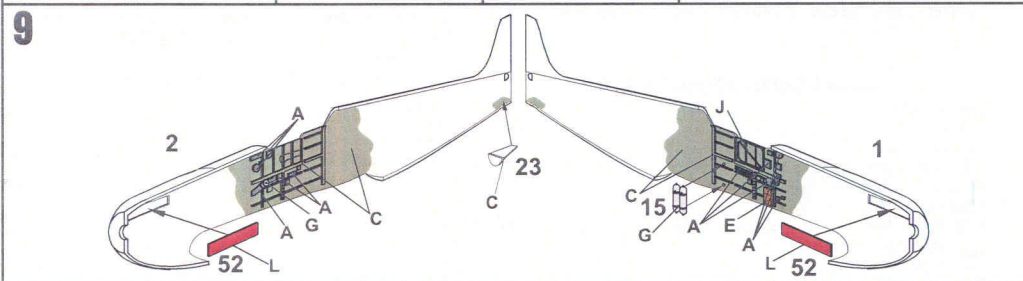
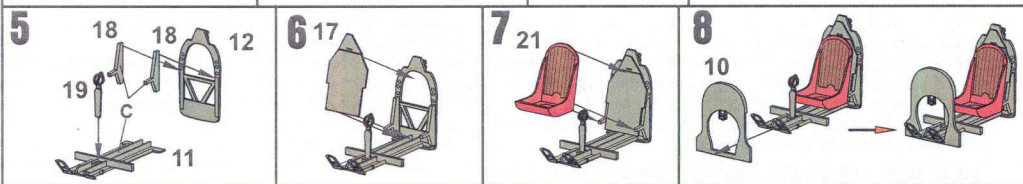
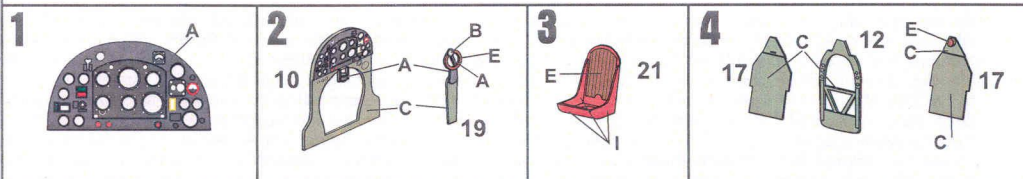
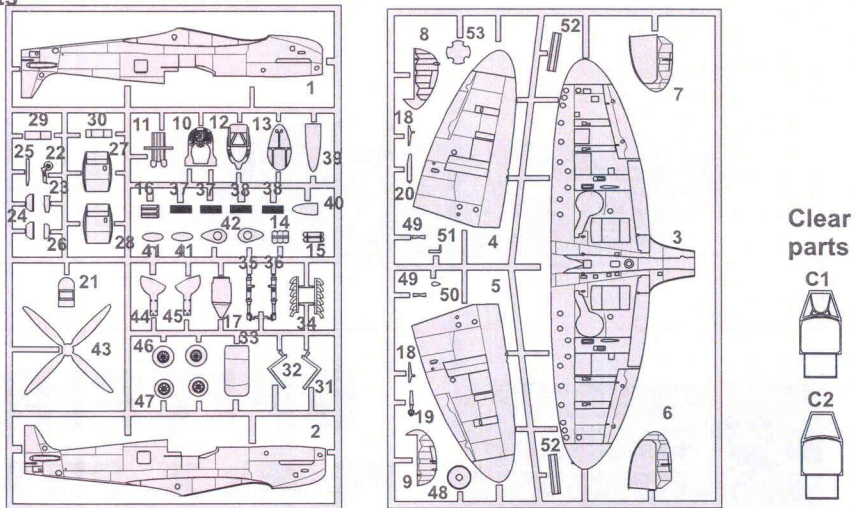

Barva	Agama - A	Humbrol - H	Barva	Agama - A	Humbrol - H
A	Černá	A07 H33	G	Hliníkový nátěr	A46 H56
B	Bílá	A01 H34	H	Stříbrná	A08 H11
C	Interior Green	AB10 H76	I	Červenohnědá	A12 H100
D	Barva hlavní	A32 H53	J	Červená	A04 H60
E	Brown	A41 H186	K	Barva pneumatik	A36 H85
F	Žlutá	AN20 H24	L	Rez	AN22 H113