

Panzer Kampfwagen II

Ausf. F/G

1/35 MILITARY MINIATURES SERIES NO.9

In the morning of September 1, 1939, the German forces consisting of the 3rd, 4th, 8th, 10th and the 14th Armies invaded Poland all heading for Warsaw, its capital. This was the beginning of the 2nd World War that had shaken the whole world for six years and the Germans made a good show of their war efforts at the start with this violent surprise offensive by massed air forces and mechanized ground forces in close co-ordination, the so-called, "Blitzkrieg". And it was none other than the Pzkwf II that had played the key role in this Blitzkrieg which started with the invasion of Poland to be followed by break-through of the Maginot-line 7 months later and ended with the surrender of France.

In anticipation of the delay in production of the two main strength tanks of the Pzkwf III and the Pzkwf IV then under development, the Ordnance Department decided in 1934 to develop a new tank instead to fill the gap. It gave specifications of the proposed new tank to the following three companies—the Mann, the Krupp and the Henschel. The specifications envisioned a tank weighing less than 10 tons and armed with 2 cm- and 7.92 mm machine guns, one each. Among the designs of the rivaling three companies presented, the one by the Mann was selected and the Mann in cooperation with the Daimler-Benz developed a first tank of the a1 type in 1935. And when 25 tanks of the same type were produced, the tank was officially named, "Panzer Kampfwagen II". After the first 25, another 25 tanks of the a2 type and 50 of the a3 type were produced in succession by 1936. Tanks of these 3 types thus produced were equipped each with a 6-cylinder, 130 HP, May-Bach HL37 engine and credited with a maximum speed of 40 km/h. However, it was decided that the horse-power was not enough and the engine was replaced with a May-Bach HL-62 one of 140 HP. The frontal armour, too, was reinforced and a new tank of the b type was produced. In 1937, the Pzkwf II was further improved and a series of new ones of the c type were produced. The c-type tanks used 5 large-sized road wheels suspended only at one end by leaf spring. This suspension system newly introduced became a common feature to all the Pzkwf II produced ever since. Also, the front portion of hull was reshaped into a more roundish form. From 1937 to the beginning of 1940, Pzkwf II of mass production types, A, B, and C, were manufactured in great numbers. To increase their productivities, the frontal armour plate was replaced with an angular single-piece one. Pzkwf II with specifications described above played the key role in the Blitzkrieg. At



ITEM 35009



TAMIYA

the start of this Blitzkrieg, the German tanks numbered 2580 in all, of which nearly half amounting to 955 in number were the Pzkwf II. In 1940, mass production of the F type was started. The new Pzkwf II was reinforced in its frontal armour (thickened to 35 mm) and side (to 20 mm). However, the improvement added its weight and its overall weight reached up to 9.5 tons. The main gun was replaced with a 20 mm KwK 30 machine gun. The gun used to be an anti-air MG but remodelled into a main gun for a tank. Frontal armour to cover upper hull, also, was changed into a plain single-piece plate. Further, a false look-out window beside the genuine one for the driver and another for the same were newly added. These were the distinct features of the F-type tanks. After the F-type ones, those of the final mass-production type G were produced. Their main guns were much more powerful KWK 38 MGs, and each tank of this type was fixed a sundries-box at the rear of gun turret. These two were main features that clearly distinguished the G type from the preceding ones.

A series of the Pzkwf II succeeding those of the G type were produced until those of the L type appeared. However, respective numbers of the Pzkwf II of types produced were all small. It is true that judged by the current standard, these Pzkwf II look quite inferior both in fire- and defensive-powers. But when compared with those of other countries active at the time, the Pzkwf II should be ranked as by far the most superior one. Indeed, its nimble mobility matching well with the German application was the driving force of the spectacular victory won by the Germans at the initial period of the World War II.

Essential Specifications of A Pzkwf II of the F Type

Overall length: 4.81 m Overall width: 2.28 m Overall height: 2.02 m
Weight: 9.5 tons
Armaments: 20 mm KWK 30 (KWK 38) machine gun and 7.92 mm machine gun, MG 34, one each
Engine: A May-Bach HL-62 water-cooled, 6-cylinder, 6191 cc. engine with an output reaching up to 140 bhp/2600 rpm.
Maximum speed: 40 km/h
Cruising distance: 125 km Number of crew: 5

About the German Tank Divisions which fought in the North Africa: —

During the period beginning from March, 1941, to May, 1943, the Axis forces composed of the German and the Italian divisions on one hand and the Allied forces consisting of the British and the U.S. troops on the other, fought a severe battle in the North African desert. And, needless to say, the key role in that fighting was played by tanks of the rivaling forces.

The German 5th Light Division (landed at Tripoli in March, 1941). This division had one tank regiment, namely, the 8th Tank Battalion. Its organization was as follows:

(This was composed of 4 companies from the 1st to the 4th but with one lacking.)
 Organization
 The 1st Battalion
 The 2nd Battalion
 (This was composed of 4 companies from the 5th to the 8th but with one lacking just as above.)

On Aug. 1, 1941, the division was reinforced with one mechanized infantry battalion and two companies consisting of the PzKpfw II. With this reorganization, the division was renamed, "the 21st Tank Division", ever afterward.

The 15th Tank Division (landed at Tripoli in May, 1941)

The division, too, had one tank battalion, namely, the 8th Tank Battalion. And its organization was quite the same as that of the 5th Light Division described above.

In September, 1941, the tank battalion was reinforced, with two tank companies (consisting of the PzKpfw II of the Type F to G) and composed of 8 companies in all.

The 10th Tank Division (landed at Tunis in December, 1942)

The division likewise had one tank battalion, namely, the 7th Tank Battalion.

(composed of 4 companies from the 1st to the 4th)
 Organization
 The 1st Battalion
 The 2nd Battalion
 Eight companies in all.
 (composed of 4 companies from the 5th to the 8th)

About the Battle of the North Africa: —

During the winter lasting from 1940 to 1941, the Italian forces which had invaded into Egypt to occupy the North Africa suffered severe damage by the attack of the British forces under the command of General Wavell. The so-called, "Battle of the North Africa" had been fought fiercely for three years between this British troops and the German Afrika Korps which were dispatched to the scene to help relieve the damaged Italian forces.

The German Afrika Korps were under the command of General Erwin Rommel, a great commander. The battle, however, should be said a tragic one for the Germans from the start, Gen. Rommel had personally thought all along that he could turn the war favourable to Germany by securing the Suez Canal and oils in Near East and around the Persian Gulf. Hitler, however, thought otherwise and recognized little strategic significance in Africa. He thus spared a force of the minimum strength to the African front and that simply in political consideration of Italy. As a result, Gen. Rommel was provided only with two divisions at first—the 5th Light Division and the 15th Mechanized Division. In March, 1941, with only the half of the 5th Light Division and the remaining Italian forces under his command, the general fought against and defeated the British troops to occupy the whole area of Cyrenaica. In the summer of 1942, Gen. Rommel again fought with the British forces far numerous than his and secured Tobruk. Later, his forces

1941

Mar. Apr.

Aug. 1

1942

Dec.

1943

May

The 5th Light Div.

The 21st Tank Division

The 15th Tank Division

The 10th Tank Division

The 8th Tank Regiment

An Example of 1st Organization—the following is the one at the time of Jan. 1941.

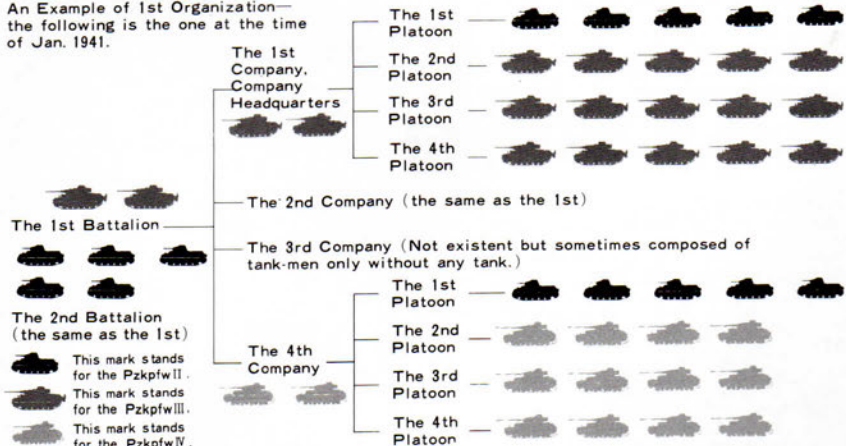

reached El Alamein, about 60 km west of Alexandria, a strategic point along the Suez Canal. However, the Rommel forces which had so far swept away all the British forces before them were abruptly forced to a standstill there and then. To add to the ever increasing British resistance, it became extremely difficult for Gen. Rommel and his forces to maintain the too-elongated supply-line of ammunitions and fuels, which had been caused by the fast advance. As the advance of his forces was stopped and the fighting line was fixed, Gen. Rommel, who returned to Germany because of strain, asked Hitler to solve this difficult problem of supply with enough ammunitions and fuels. But Hitler refused to grant his request.

While he was away from the North Africa, General Montgomery, a new commander for the British forces there, made a great counterattack being as-

sisted with a vast amount of material supply. On returning to the front, Gen. Rommel with his forces of scant strength put up a good fight against the advancing British forces giving a considerable blow to the latter. But in the end, he and his forces were forced to retreat to Tunisia. Under the circumstances, the general suggested abandonment of Africa to Hitler but his suggestion only brought the latter's wrath upon himself. In March, 1943, Gen. Rommel was relieved of his post and the remaining Afrika Korps formerly under his command surrendered to the British forces on May 12. Although defeated, the German, Afrika Korps under his command inflicted a heavy loss on the British forces and Gen. Rommel himself was feared as Desert Fox. The Allied forces had even acclaimed him as the greatest commander during the World War II.

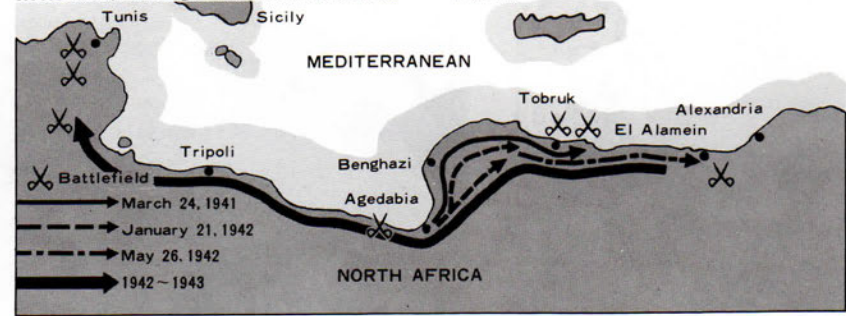

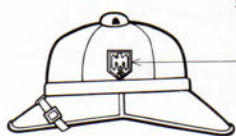

Tropical Cap

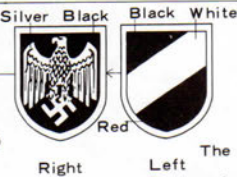

Right

Left



The national emblem

(B) An armband should be attached onto the right arm of the uniform, 15mm above the arm end.



Field caps for the Afrika Korps



(C) Armband

(A) Armband for the Afrika Korps

AFRIKAKORPS

AFRIKAKORP

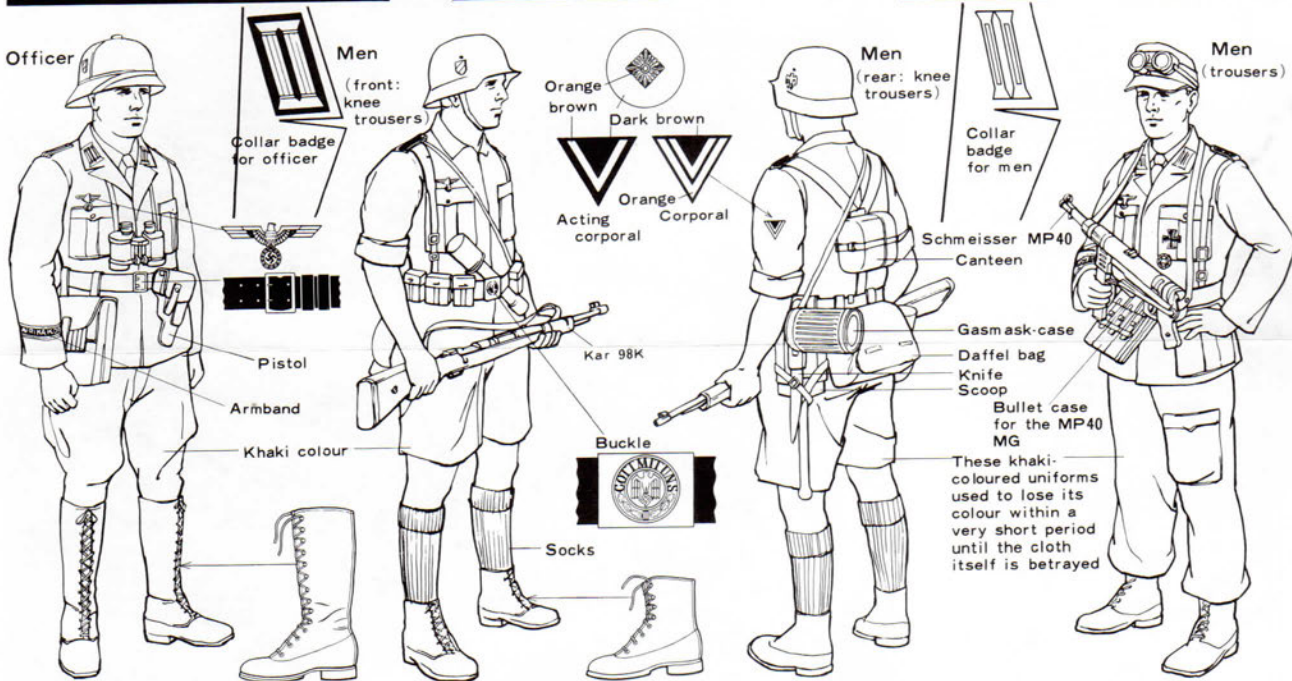

About the armbands for the Afrika Korps' soldiers: — The unofficial armband worn during the initial period.

(A) This unofficial armband apparently had been produced either in France before the Afrika Korps' embarkation for Africa, or immediately after landing at Tripoli. However, it had been worn for a short period.

(B) The first official armband adopted on July 18, 1941: The outermost lines on this armband were done in light brown, while letters and lines just above and below, in silver and the ground, in green.

(C) The last official armband adopted on January 15, 1943: Its ground cloth was coloured in khaki and cut in 33 mm width, while two coconut tree designs, letters and two stripes above and below were all done in silver. This armband commanded the same respect as that of the war-participant badge and was conferred on those who had the following qualifications.

- Those who participated in the North Africa operation for six months.
- Those who participated in the above operation for only 3 months but became invalids during the period under attack of the tropical disease, and
- Any of those who had been conferred with a trifling service medal during the operation was also qualified regardless of length of his participation.

About the tropical uniforms officially adopted for the German Afrika Korps' men and officers: —

Before 1941, no tropical combat uniforms were provided to these men and officers participating in the North Africa operation. However, during the years from 1941 to 1943, uniforms of very numerous kinds were employed. As for cloth of the tropical uniform and the cap, they were coloured either in light olive green or khaki and either of these differently coloured one was provided. Other colourings of the uniforms were as follows: Shirt in khaki, a pair of stockings in light brown, upper portions of a pair of boots which were made of canvass in khaki, trousers, breeches and riding breeches in khaki, all helmets in sand colour and belt in light brown.

PAINTING

In constructing dummies, painting is the most important work. Get the following tools and paints ready and start painting of each dummy carefully. Tools and paints: A thin brush a pair of tweezers, a series of matted or bright paints used exclusively for the plastics — white, flesh tint, yellow, reddish light brown, green, blue, black and silver paints.

Collar Badge

Private, Private 1st class, Lance-corporal, Corporal	Sergeant major
Silver	Silver
Staff sergeant	2nd lieutenant
Silver	Silver
Sergeant White	1st lieutenant
Technical sergeant	Captain
Sergeant 1st class	Major White
Silver	Silver

Panzer Kampfwagen II Ausf. F/G

★ Be sure to read instructions before you start each construction work in numerical order.

★ Get a knife, a driver, a pair of nippers, a file and other necessary tools ready.

★ Cut each parts off the runner carefully with either a pair of nippers, or a knife. But it won't do to pluck it away with your hand.

Painting Instructions:

★ Painting of a No.2 tank kit should be done after it has been fully constructed.

③ Construction of Gun Turret can be done in two ways:

One way (Type G) is to have it glued with Parts. 16 and 17, while the other (Type F), glued with Parts. 27, instead of two Parts already referred to above. So, make your choice and proceed with either of way construction.

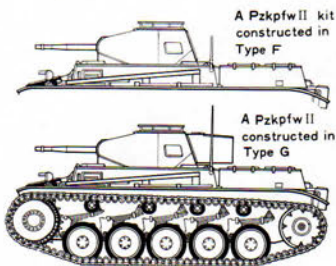

Good Way to Fasten Caterpillars — Flattening of Connecting Pin Head by Heating

★ When heating pin head, use either splittable chopsticks inserted with a nail, about 2.5cm long, or a screw driver with an extremely thin end.

① Firmly fix one end of a Caterpillar onto a desk with Scotch tape and insert pin at the other end through the hole at one end of other Caterpillar to be fastened together. Then, lightly warm the pin head that comes out of the hole with either a nail head or a driver's end, either of which has been heated by a candle fire or other means. ② Flatten the pin head immediately afterward with your finger and two Caterpillars will be firmly connected together.

★ When the connecting portion is either broken off, or flattening has been two slight to hold the two Caterpillars firmly together, secure the connection further with a black thread or a Hotchkiss paper-fastener as shown in the figure at left.



Construction of dummy

Tank Crew

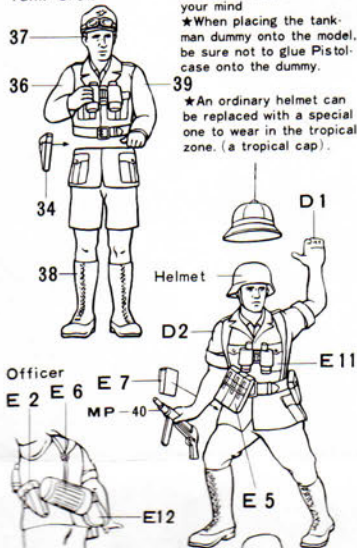

★ Tank-man dummies are specially made parts different from other dummies in the kit. Keep this on your mind.

★ When placing the tank-man dummy onto the model, be sure not to glue Pistol-case onto the dummy.

★ An ordinary helmet can be replaced with a special one to wear in the tropical zone. (a tropical cap).

1 Construction of Lower Hull

When constructing Lower Hull, firstly, glue Parts. 14, onto Lower Hull. Then, glue Parts. 5, onto Parts. 14, and Lastly, Parts. 20, onto Parts. 14.

Fix & glue these two below onto Lower Hull from inside.

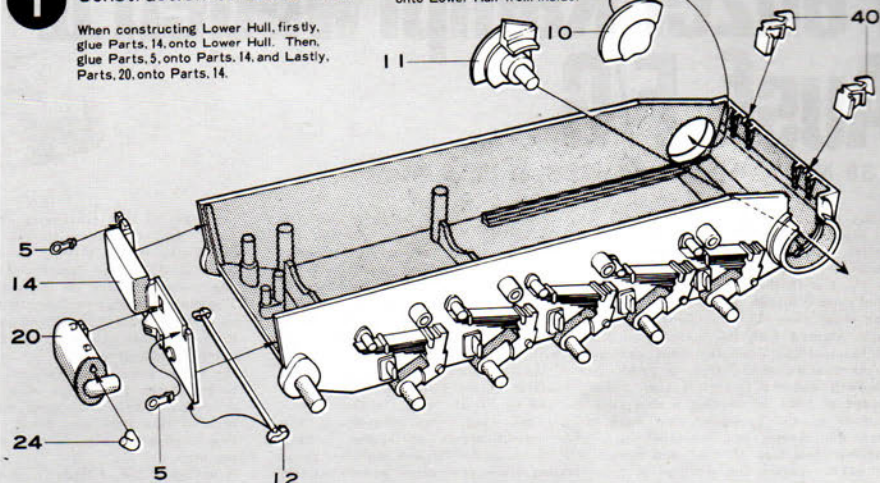

2 Construction and Fixing of Wheels

Drive Sprocket

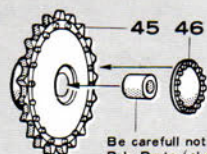

Be careful not to have Poly Parts (short) smeared with adhesives. ★ Poly Parts (long) is not needed here.

Rear wheel

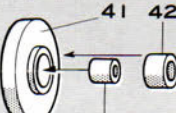

Poly Parts (short)

Road wheel

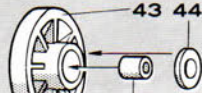

Poly Parts (short)

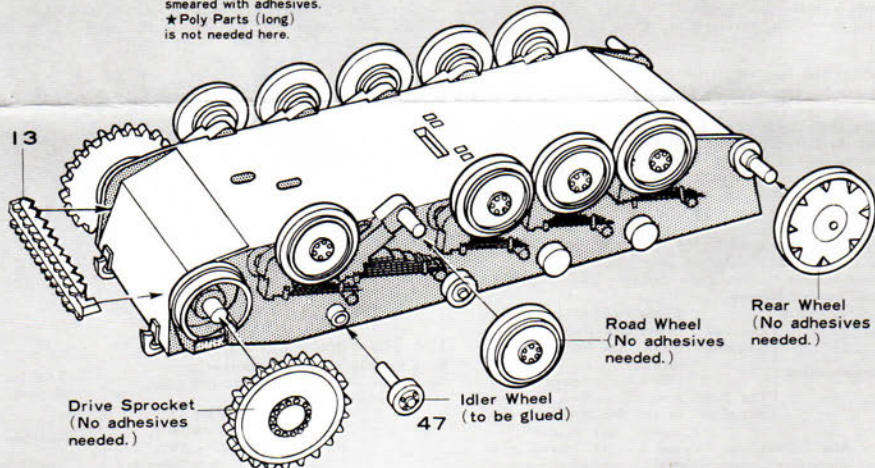

3 Construction of Gun Turret

(As stated above, when the Type-F construction is preferred, glue Parts. 27, while for Type-G construction, Parts. 16 and 17.)

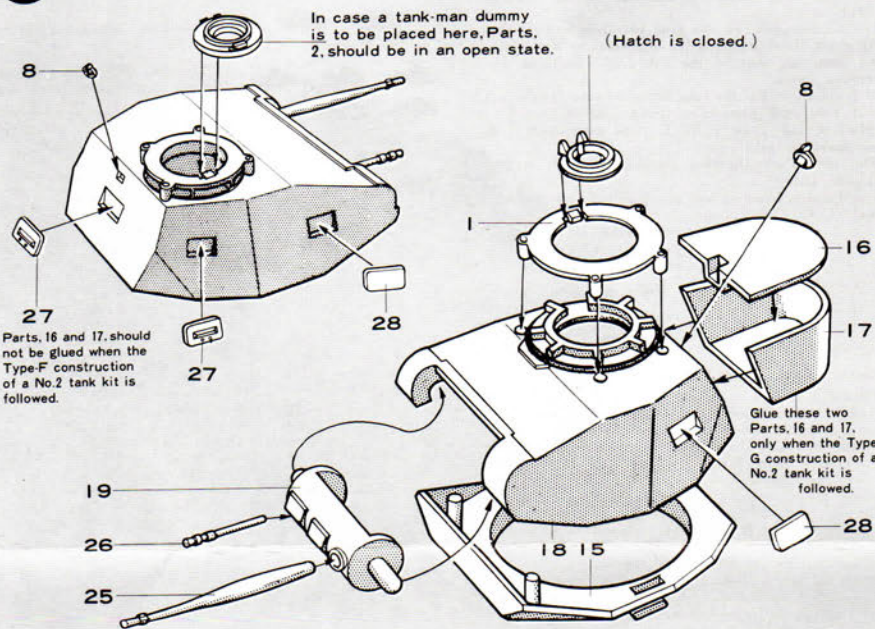

In case a tank-man dummy is to be placed here, Parts. 2, should be in an open state.

(Hatch is closed.)

Parts. 16 and 17, should not be glued when the Type-F construction of a No.2 tank kit is followed.

Glue these two Parts. 16 and 17, only when the Type-G construction of a No.2 tank kit is followed.

4 Construction of Upper Hull

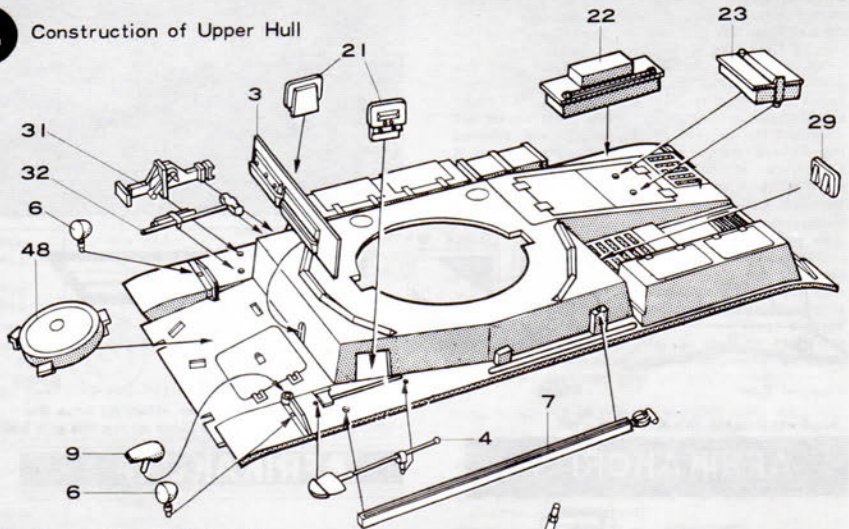

5 Connection of Caterpillars and Completion of Hull.

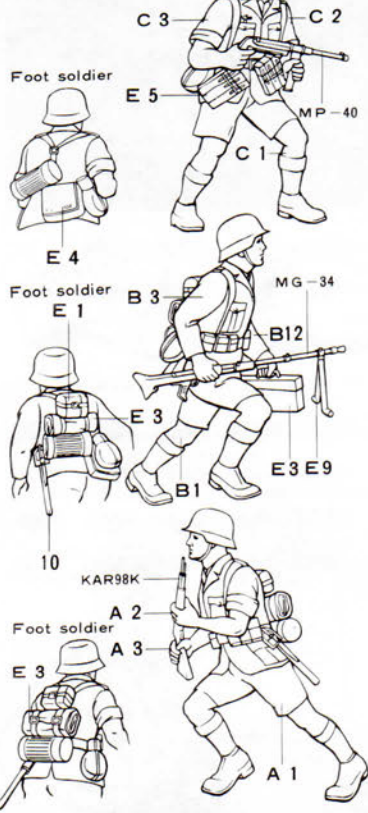
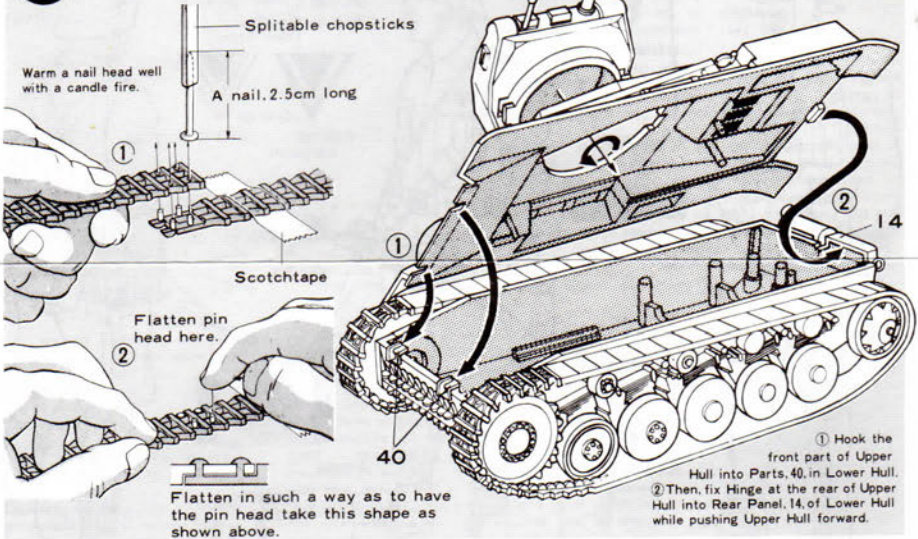
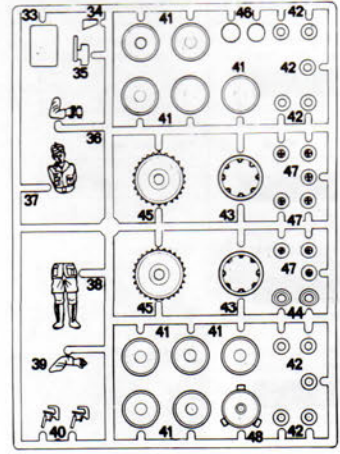
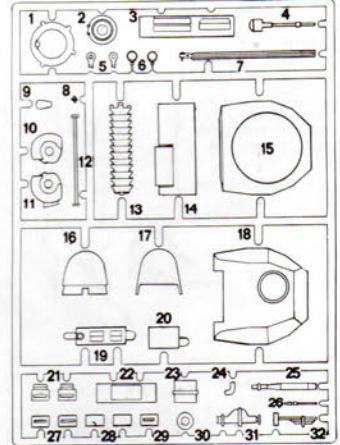

Figure of Parts Parts, 30 & 35 are non-essential ones.



APPLYING DECALS



〈マークの説明〉

第18戦車師団	第3戦車師団	第6戦車師団
第18戦車師団	第3戦車師団	第15機甲師団
		アフリカ軍団マークはアフリカ戦に登場した戦車ならどれにでもはることができる。
第21戦車師団		

PAINTING

迷彩塗装

(スプレー式タミヤカラーによるボカシの方法)

★用意するもの

綿、大和のり、タミヤカラー(ダークイエロー、レッドブラウン)

(1)戦車全体に基本色(レッドブラウン)をプラスチックの色が見えるくらいにうすく塗装し、10分間乾くの待ってもう一度同じように塗装します。1時間ほど乾燥時間を置いて下さい。

(2)表面にある迷彩表を参考にして、基本色を綿でかくします。綿はできるだけほぐし、のりは少なめにしてはりつけます。

(3)基本色と同様に迷彩色を全体に塗ります。車体の下方も忘れないうで下さい。うすく3回塗りぐらいで仕上げます。

(4)20分ほどして綿をとって下さい。のりが付いている車体はタミヤカラーが乾くの待って(30分)水洗いをして下さい。

綿をつけた状態



塗装した戦車



① 第18戦車師団所属車 (車体色、ジャーマングレー)

II号戦車G型

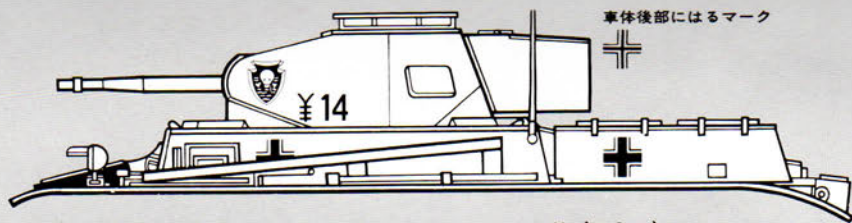

② 第3戦車師団所属車 (車体色、ダークイエロー+レッドブラウン)

II号戦車G型

車体前部にはるマーク

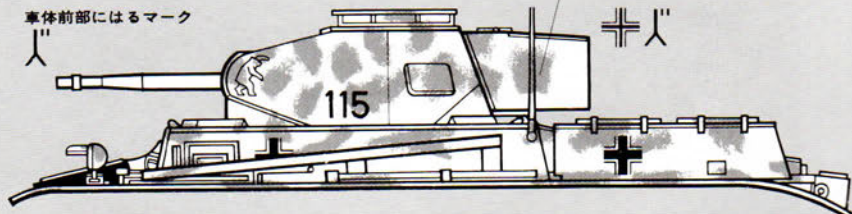

③ 第15機甲師団所属車 (車体色、ダークイエロー)

II号戦車F型

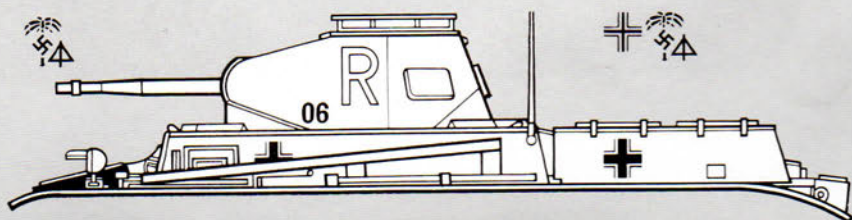

④ 第21戦車師団所属車 (車体色、ダークイエロー+ダークグリーン)

II号戦車G型

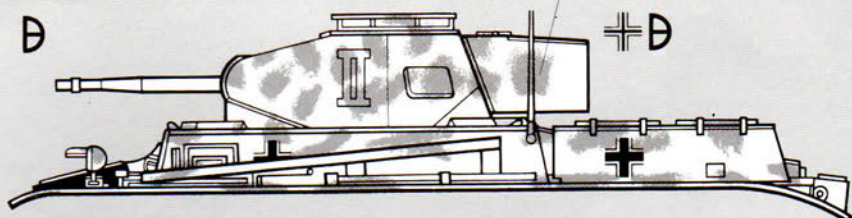

⑤ 第6戦車師団所属車 (車体色、ジャーマングレー)

II号戦車G型

反対側

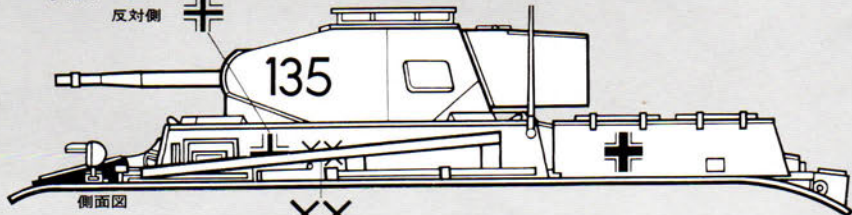

側面図

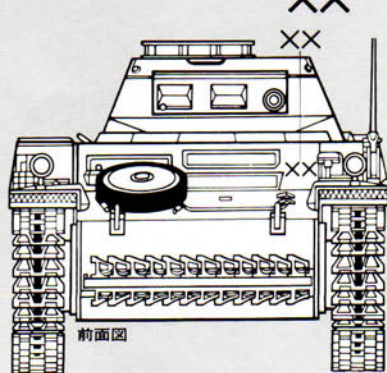

前面図

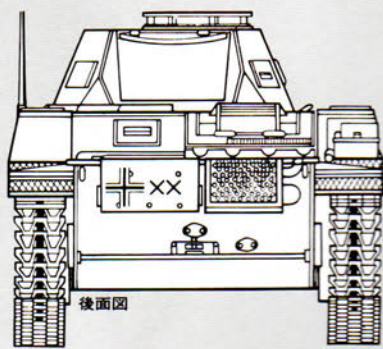

後面図