

German Half-Track

HANOMAG

Sd. Kfz. 251/1

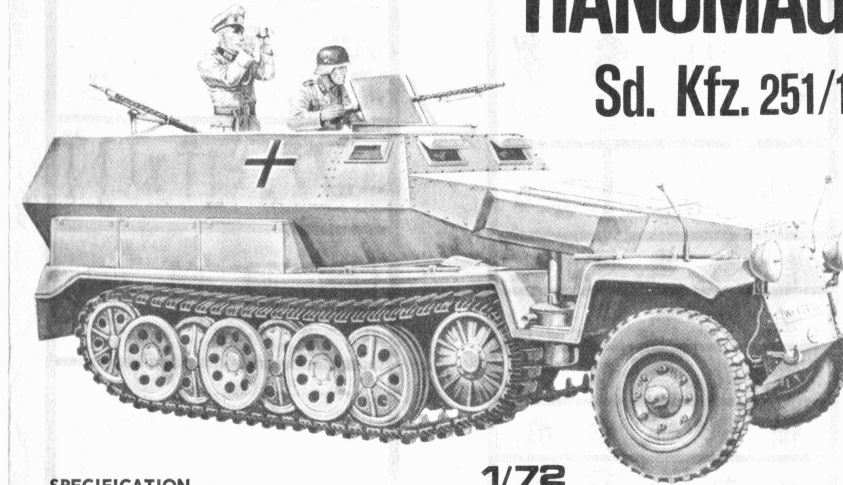

SPECIFICATION

1/72

KIT 8002

GENERAL:

DESIGNATION; MITTLERER GEPANZERTER MANNSCHAFTKRAFTWAGEN. DESIGNATION FROM 1942; MITTLERER SCHUTZENPANZERWAGEN. ORDNANCE No. SdKfz 251. MANUFACTURER'S TYPE: HANOMAG HL KI 6p.

CREW: 12—COMMANDER, DRIVER, 10 MEN INFANTRY SQUAD, IN BASIC SdKfz 251/1.

BATTLE WEIGHT: 8.9 LONG TONS.

DRY WEIGHT: 7.4 TONS.

DIMENSIONS

LENGTH OVERALL: 19 ft. (AUSF. A, B AND C). 19 ft. 7½ in. AUSF. D.

HEIGHT: 5 ft. 9 in.

WIDTH: 6 ft. 11 in.

WIDTH OVER TRACKS/OVERALL: 6 ft. 11 in.

TRACK CENTRES/WHEEL BASE: 5 ft. in./5 ft. 3 in.

TRACK WIDTH: 9¼ in.

ENGINE

MAYBACH "HL 42 TUKRM" OR TUKRRM. PETROL. 6 CYL. IN-LINE. 4,171 c.c. 100 b.h.p. AT 2,800 r.p.m. FUEL: 35 GALLONS IN ONE TANK BETWEEN FRAME.

ARMOR
ESCI

PERFORMANCE

MAX. ROAD SPEED: 33 m.p.h.

MAX. GRADIENT: 24°.

TRENCH: 6 ft. 6 in.

WADING DEPTH: 2 ft.

FUEL CONSUMPTION 3-5 m.p.g.

MADE IN ITALY

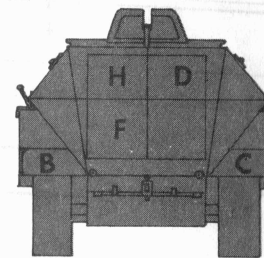
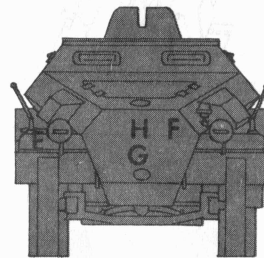
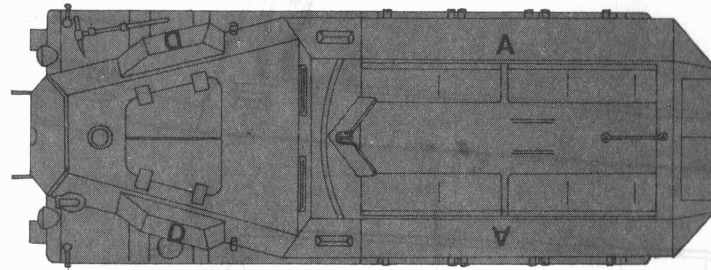
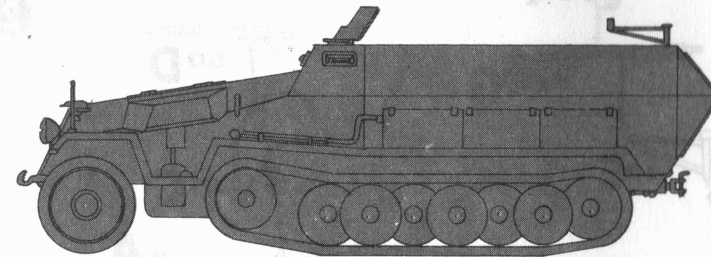

HANOMAG Sd. Kfz. 251/1

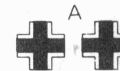

B WH-634500 C WH-634500 GGG 21 F F WH-634500
D E F G

B WH-667117 C WH-667117 WH-667117 Y Y F F F F
G H F F

WH-816297 B WH-816297 C WH-816297
A H G

ESCI - MILANO - MADE IN ITALY

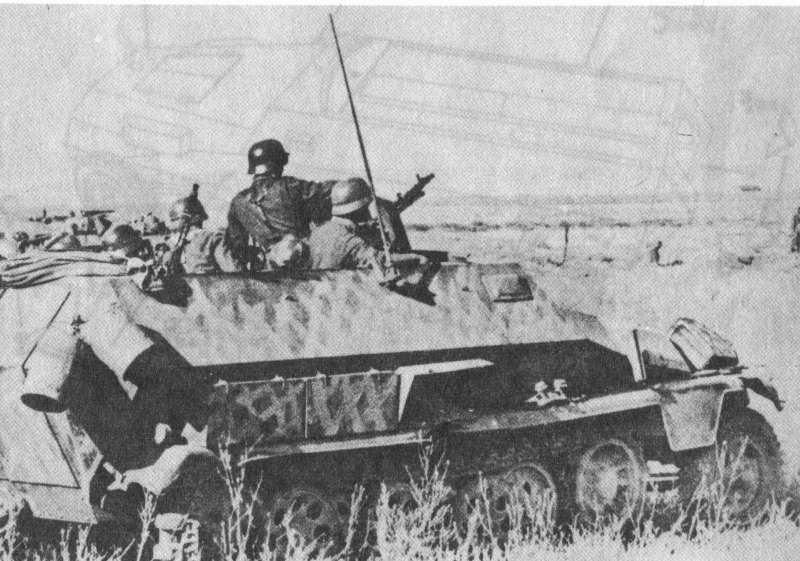
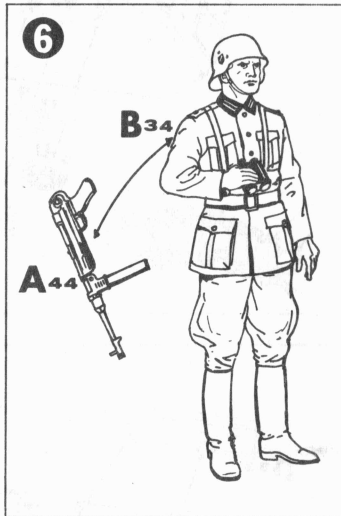
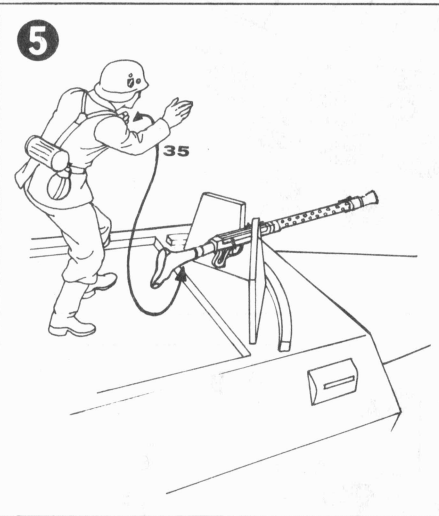

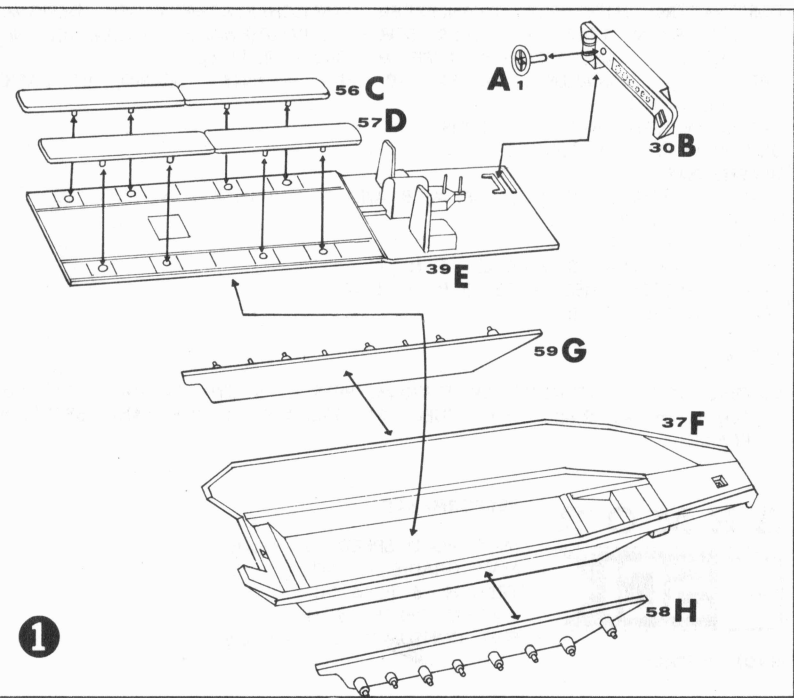
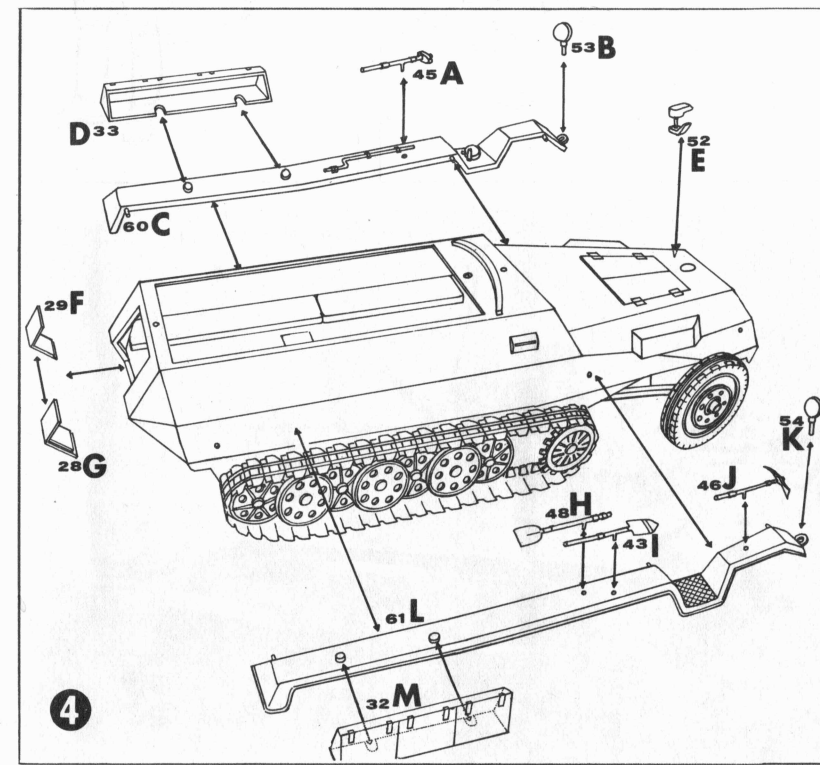
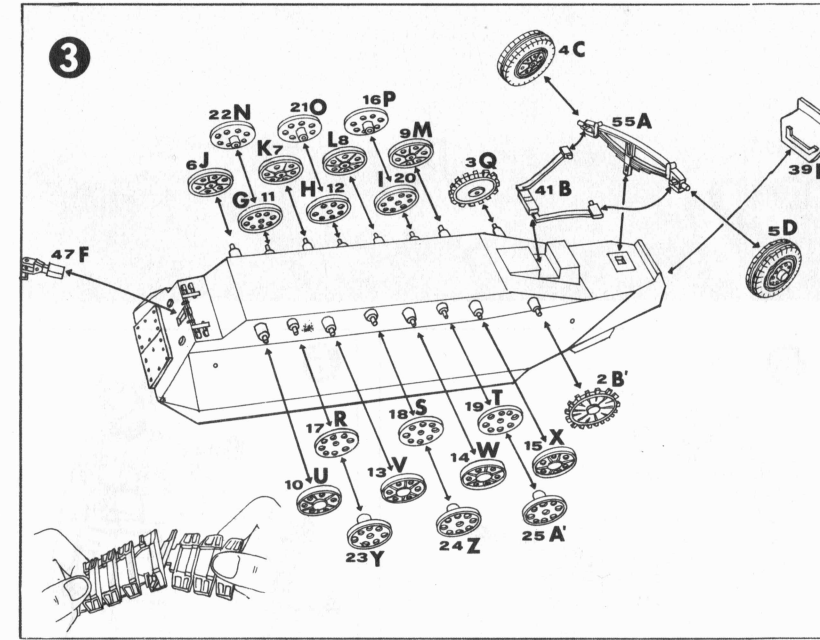
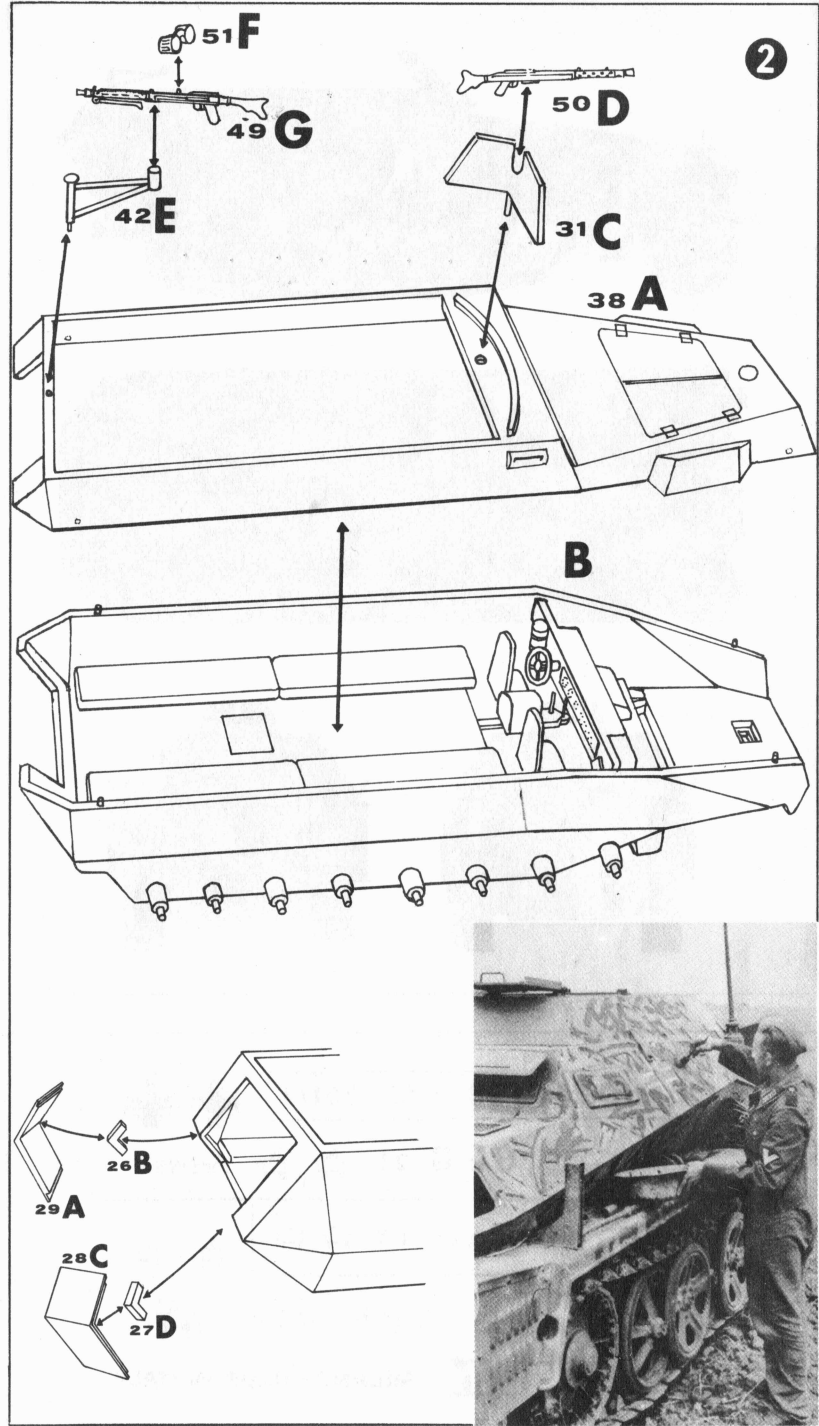
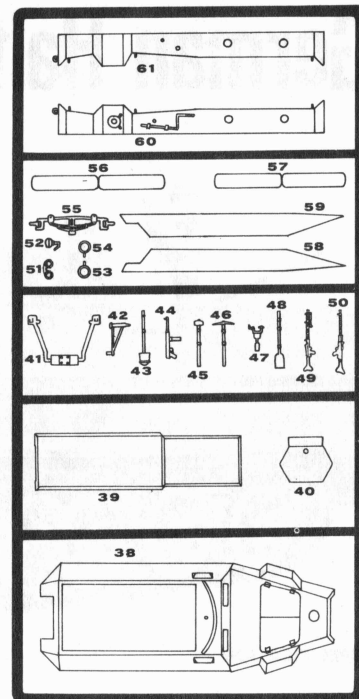
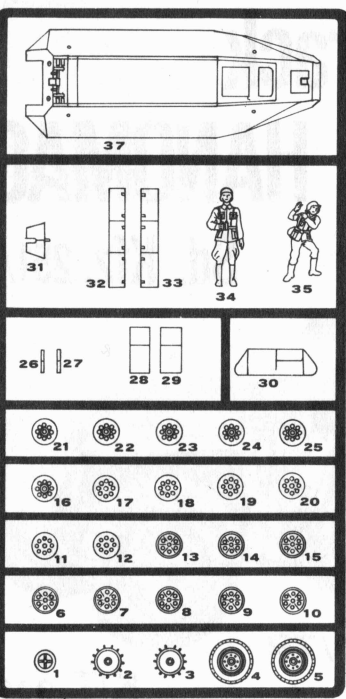

1

2

3

4